







Treadle Pump Instruction Manual

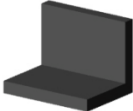







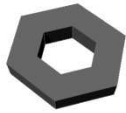





Table of Contents







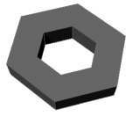

Table of Contents	i
Parts Listing	ii
Frame Assembly	1
Rocker-arm Assembly	9
Treadle Pivot Assembly	15
Piston seals	19
Pump Assembly	22
Piston Assembly	27
Attaching the pump	29
Attaching Treadles	30
Treadle Maintenance	31
Seal Maintenance	31
Cylinder Maintenance	31



Frame/Rocker-arm/Treadle Parts List

Part	Quantity	Dimensions	Picture	Position on Pump
Steel Angle Bar	2	¼" thick, 1 ½" wide, 48" long		Figure 1.0
Steel Angle Bar	1	¼" thick, 1 ½" wide, 28 ½" long		Figure 1.1 Figure 1.2
T-Shaped Bar	1	¼" thick, 2" wide, 28 ½" long		Figure 1.3
T-Shaped Bar	1	¼" thick, 1 ¼" wide, 28 ½" long		Figure 1.5
T-Shaped Bar	1	⅛" thick, 1 ¼" wide, 28 ½" long		Figure 1.6
Steel Square Channel	2	¼" thick, 2" wide, 23 ½" long		Figure 1.7 Figure 1.8 Figure 1.9 Figure 2.0

Steel Pipe	1	$\frac{1}{8}$ " thick, 1 $\frac{1}{4}$ " diameter, 24" long		Figure 2.1
Steel Angle Bar	2	$\frac{1}{4}$ " thick, 1 $\frac{1}{2}$ " wide, 2" long		Figure 2.3
Steel Rod	1	1" diameter, 5" long		Figure 2.4
Sheet Metal	2	$\frac{1}{8}$ " thick, 4 $\frac{1}{2}$ " wide, 17" long		Figure 2.6 Figure 2.7 Figure 2.8 Figure 2.9
PVC	2	inner diameter of 1", $\frac{1}{2}$ " long		Figure 3.1
Rubber	2	4 $\frac{1}{2}$ " x 3" x 2"		Figure 3.2 Figure 3.3 Figure 3.4 Figure 3.5
Steel Bolts	6	$\frac{3}{8}$ " diameter, 3" long, (preferably only threaded last 1")		Figure 3.6

Nuts	6	$\frac{3}{8}$ " diameter		Figure 3.6
Washers	12	$\frac{1}{2}$ " diameter		Figure 3.6
Rods w/ eye hooks on each end	2	$\frac{1}{2}$ " diameter, 14" long (including eye hooks)		Figure 3.6
Block of Wood	2	4" x 4" x 4"		Figure 3.7
Steel Angle Bar	4	$\frac{1}{4}$ " thick, 1 $\frac{1}{4}$ " wide, 6" long		Figure 3.8 Figure 3.9
PVC	2	1 $\frac{1}{4}$ " inner diameter, 4" long		Figure 4.0
Bolts	8	$\frac{1}{4}$ " diameter, 5" long		Figure 4.1
Nuts	8	$\frac{1}{4}$ " diameter		Figure 4.1

PVC	2	1 ¼" inner diameter, 5" long		Figure 4.2
PVC	1	1 ¼" inner diameter, 7" long		Figure 4.2
Sheet Metal	1	1/8" thick or less, 6.50" x 42.50"		Figure 4.5
Bolts	4	¼" diameter, 1" long		Figure 4.5
Nuts	4	¼" diameter		Figure 4.5
Washers	4	¼" diameter		Figure 4.5
Wood (2x6)	2	2" x 6" x 42"		Figure 4.6
Bolts	8	¼" diameter, 3" long		Figure 4.7

Washers	16	¼" diameter		Figure 4.7
Nuts	8	¼" diameter		Figure 4.7

Assembly Instructions

FRAME

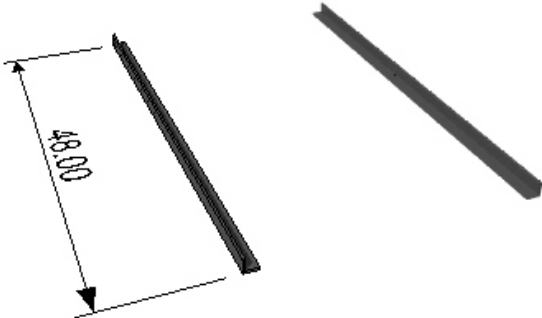

Figure 1.0

Place the two 0.25" thick, 1.5" wide and 48" long angle pieces parallel to each other.



Figure 1.1

Next place the 0.25" thick, 1.5" wide and 28.5" long angle piece on top at one end of the other two pieces so that the sides are flush and form a 90 degree angle with each other.

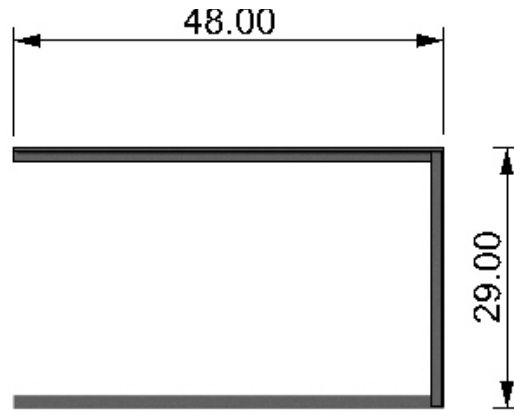

Figure 1.2

Now weld one end of the 28.5" angle piece from figure 1.1 to one end of one of the 48" angle pieces to form a 90 degree angle, with the 28.5" piece on top of the 48" piece. Do the same thing on the other side with the other 48" long angle piece, making sure the 28.5" piece is on top. Refer to figure 1.2 above.

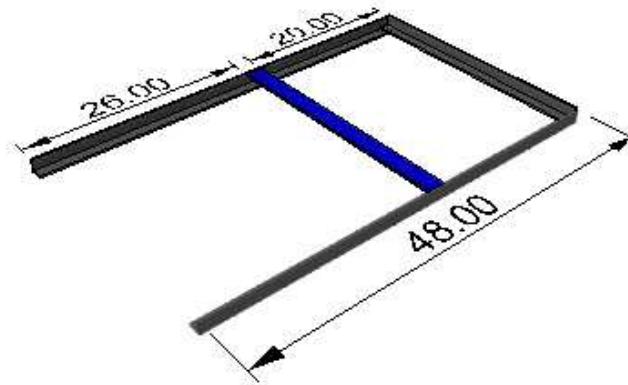

Figure 1.3

So now you have a frame in the shape of a 'U'. Take one of the 0.25" thick, 2" wide t-shaped bar that you previously cut to 28.5" and place that on top from one angle piece to the other so the flat side is up 20" from the end of the 48" long angle piece from the end where you just welded. Make sure this is a good weld and level to the rest of the frame. The center post will be extending off this beam so it needs to be sturdy.

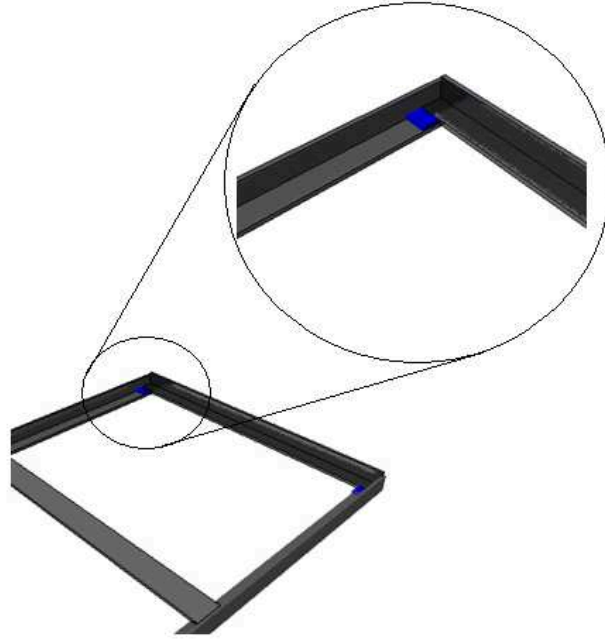

Figure 1.4

Take some scrap metal of 0.25" thickness and weld it to both 48" long angle pieces in front of the angle piece going across the back. Try and make this as level with the angle piece going across the back as much as possible. It only needs to be about 2" by 1". Refer to the magnified portion in figure 1.4 above.

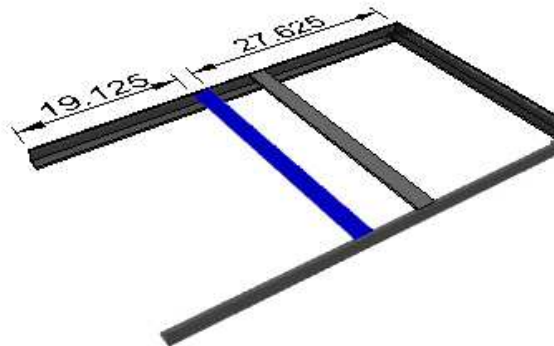

Figure 1.5

Take the 0.25" thick, 1.25" wide t-shaped bar that you previously cut to 28.5" and place that, flat side up, 19.125" from the open side of the frame and 27.625" from the side of the frame with the angle piece going across the back end. Again make sure it is level and a sturdy weld since the pumps will be resting on it. Refer to figure 1.5 above.

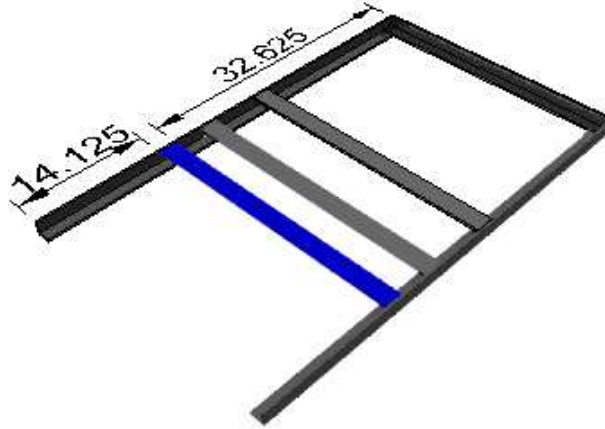

Figure 1.6

Now take the 0.125" thick, 1.25" wide t-shaped bar that was cut to 28.5" long. Place this bar with the flat side up, parallel to the other welds and 14.125" from the open side of the frame and 32.625" from the side with an angle piece going across the back. Refer to figure 1.6 above.

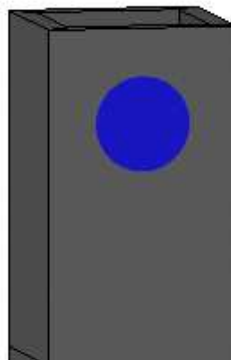

Figure 1.7

Take both of the 0.25" thick, 2" wide and 23.5" long square channels and drill a hole 1" in diameter in each so the center of the circle is 1.5" from the top and 1" from either side of the edge. Make sure to measure on both sides and make a good straight cut on opposite side of the channel. So you will end up with two holes in each channel on the same end of the square channel but on opposite sides.

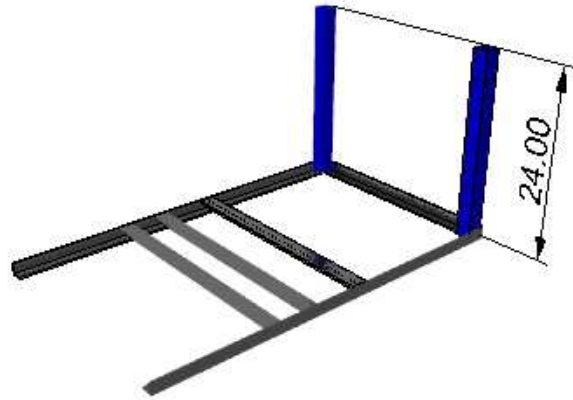

Figure 1.8

Now take both the square channels from figure 1.8 that you just drilled the holes in and stand them up in the corner of the frame where the 28.5" long angle piece and the 48" angle piece form a 90 degree angle. Make sure the end with the holes is on top and the holes are pointing perpendicular to the two 48" long angle pieces. Press them as far into the corner as possible and then weld thoroughly. This has to be a strong weld since it will take much of the force. It should be about 24" tall once it is put into place. Refer to figure 1.8 above for placement of the square channels.

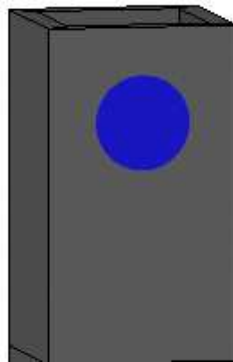

Figure 1.9

Now we are going to assemble the center post with the handle. Take the 64" square channel and drill a hole 1.25" in diameter so the center of the hole is 4" from the top and 0.375" from either side of the channel. Just like you drilled through the opposite side as well for the other square channels in figure 1.7, you are going to do the same thing here. Just remember to measure and drill each side separately. You should end up with a hole on opposite sides of the channel and only on the one end.



Figure 2.0

On the other sides of the square channel that you didn't drill the holes in, drill a 1" hole in diameter 1" from the side of the square channel and 6" from the end of the square channel that you didn't drill the holes in.

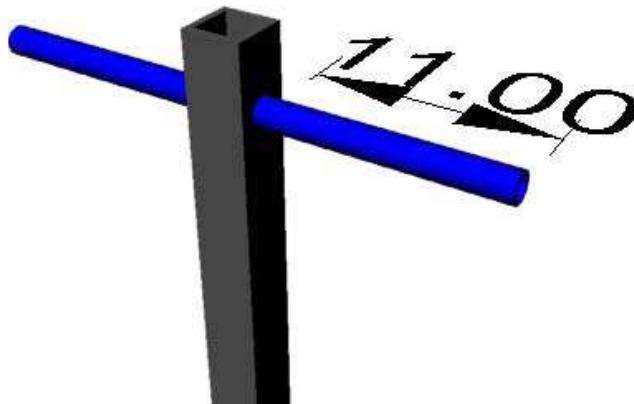

Figure 2.1

Take the 0.125" thick, 1.25" diameter and 24" long pipe that you previously measured insert it in the 1.25" hole you drilled in the square channel in figure 2.1. Center the pipe so there is 11" of pipe sticking out on either side of the square channel. Now weld the pipe in place.

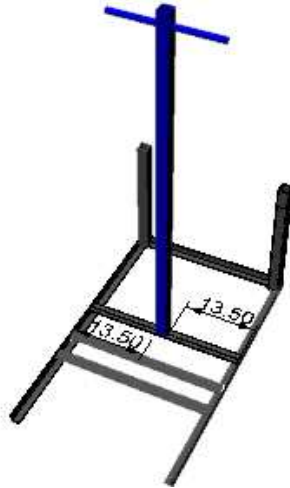

Figure 2.2

Now take the 64" square channel with the bar going through the top and stand it up with the bar on top running parallel to the t-shape bar that it's standing on, the t-shape bar closest to the closed end of the frame. The square channel should be placed 13.5" from either side of the frame. Refer to figure 2.2 above for the correct placement and positioning of the central post.

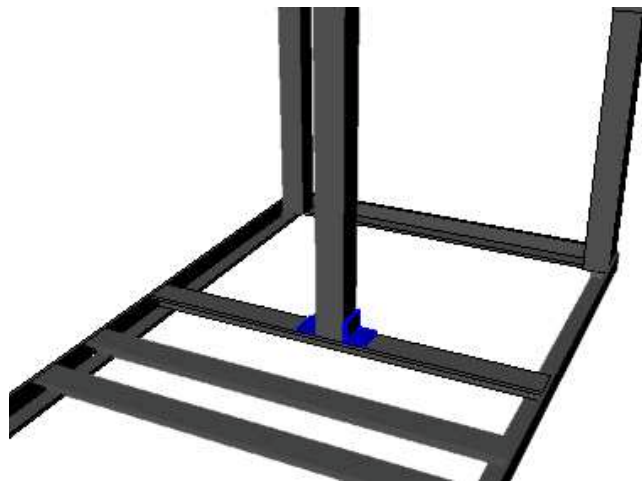

Figure 2.3

Take two angle pieces, each 0.25" thick, 1.5" wide and 2" long and weld them to the center post and the t-shaped beam that it rest on. This will provide more support for the center post. Refer to figure 2.3 above.

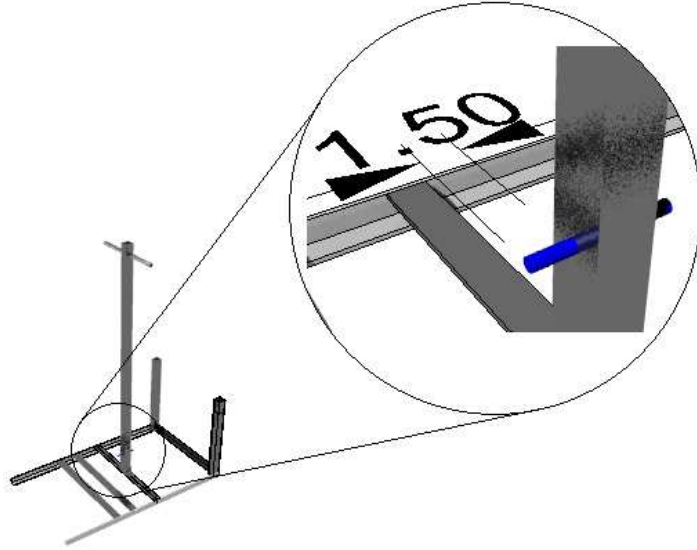

Figure 2.4

Take the 1" diameter, 5" long steel rod and slide it in the hole in the central post that is 6" high from the base. Make sure there is equal length of the rod on either side of the square channel; there should be 1.5" on either side of the square channel. Refer to figure 2.4 above.

Assembled thus far...



Figure 2.5: Basic Frame

Rocker-arm

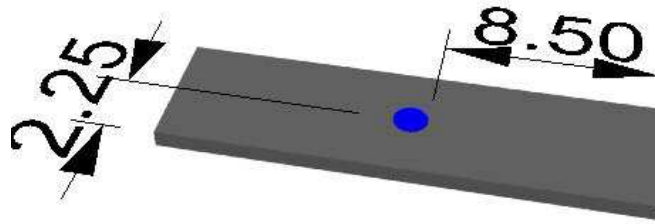

(x2)

Figure 2.6

Grab both of the 0.125" thick, 4.5" wide and 17" long pieces of sheet metal. Drill a hole to the outer diameter of the 1" diameter PVC pipe. It will probably be around 1.25" but measure it just to make sure. Drill this hole 8.5" from the end of the sheet metal and 2.25" from the side. Do this for both pieces.

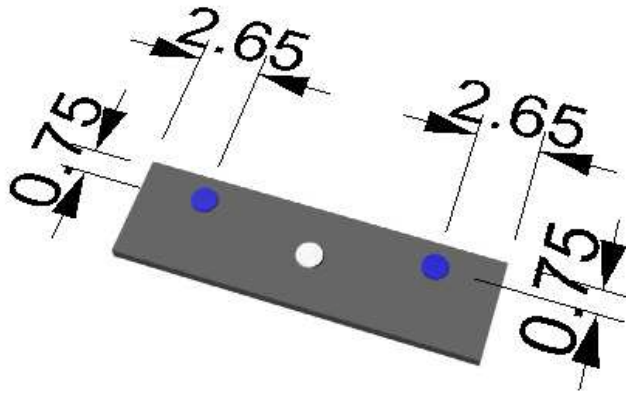

(x2)

Figure 2.7

Now drill a hole 1" in diameter through the sheet metal 0.75" from the top of the plate. Drill an identical hole on the other end of the plate using the same dimensions. Repeat this process for the other identical plate. Refer to figure 2.6 above for positioning of the holes.

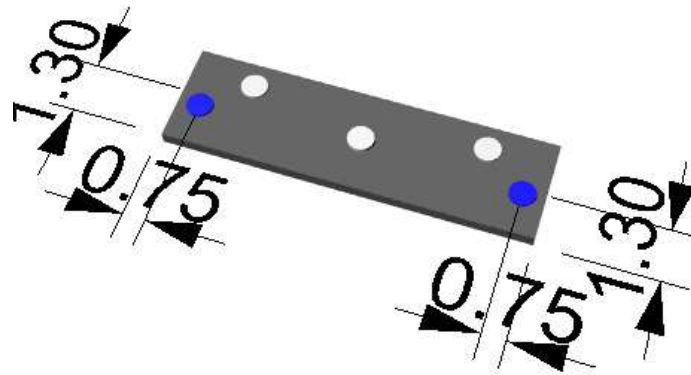

(x2)

Figure 2.8

Now drill a hole 1" in diameter through the sheet metal 1.3" from the bottom of the plate and 0.75" from the side of the plate. Drill an identical hole on the other end of the sheet metal. Repeat this process for the other identical piece of sheet metal. Refer to figure 2.7 above for positioning.

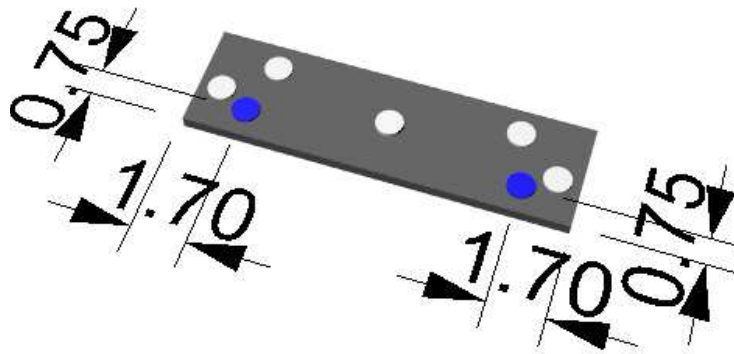

(x2)

Figure 2.9

In that same corner drill another hole of diameter 1" and 0.75" from the bottom of the plate and 1.7" from the side. Drill an identical hole on the other end of the sheet metal. Repeat this process for the other identical piece of sheet metal. Refer to figure 2.8 above for positioning.

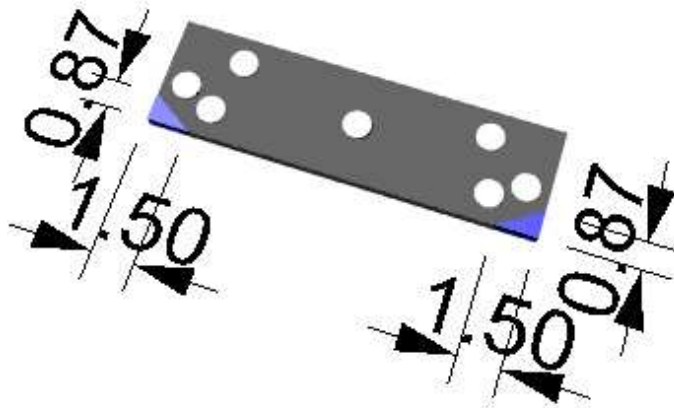

Figure 3.0

Take both pieces of sheet metal and measure 0.87" from the bottom corner with the two holes you drilled there and 1.5" from the side. Draw a line from edge to edge at those two measurements. Do the same thing on the other side as well. Now cut the corner off on the line you just drew. Refer to figure 2.9 above for the correct orientation of the cut.

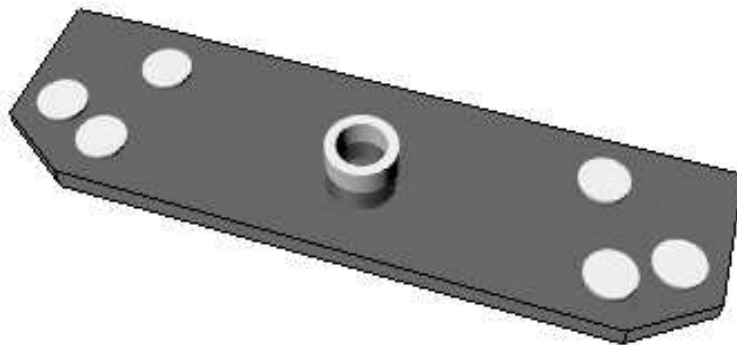

Figure 3.1

Press feed one of PVC pieces of 1" diameter and 0.5" long into the central hole in each of one of the sheet metal pieces that you just drilled seven holes in. Do the same thing to the other piece of sheet metal. Refer to figure 3.0 above.

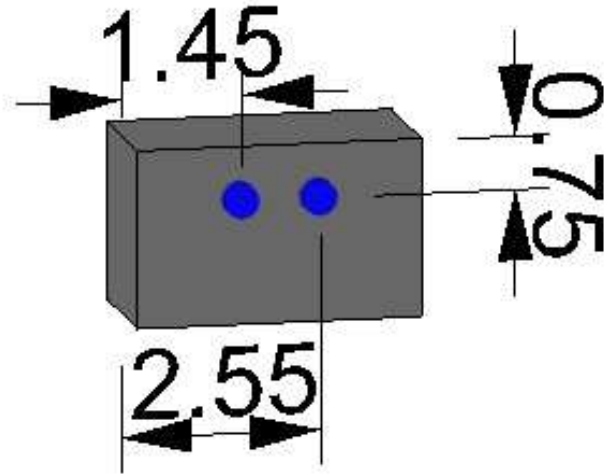

Figure 3.2

Take one of the rubber blocks and drill a hole straight through with 0.5" diameter and 1.45" from the left side and 0.75" from the top. Then drill an identical hole 2.55" from the left side and 0.75" from the top. Refer to figure 3.1 above.

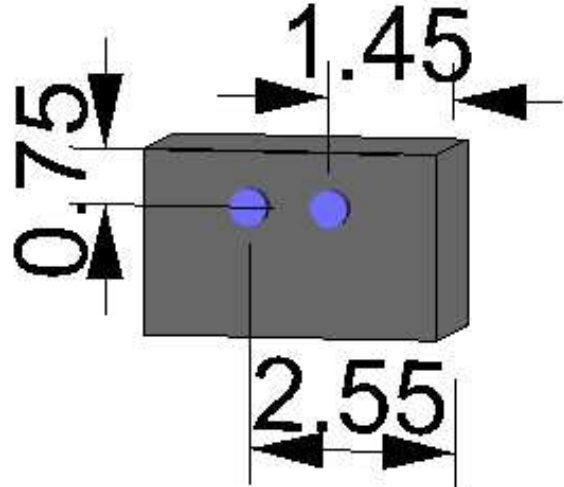

Figure 3.3

Take the other rubber block and do the same thing but this time measure from the right. Drill a hole straight through with 0.5" diameter and 1.45" from the right side and 0.75" from the top. Then drill an identical hole 2.55" from the right side and 0.75" from the top. Refer to figure 3.2 above.

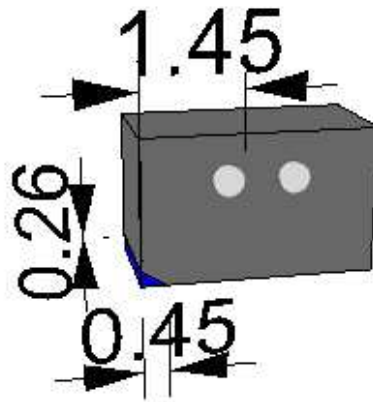

Figure 3.4

Now take the rubber block from figure 3.1 and measure 0.45" from the same side you measured from before, the left side, and measure 0.26" from the bottom, opposite the holes. Draw a line connecting these two points and cut the corner off along this line. Refer to figure 3.3 above.

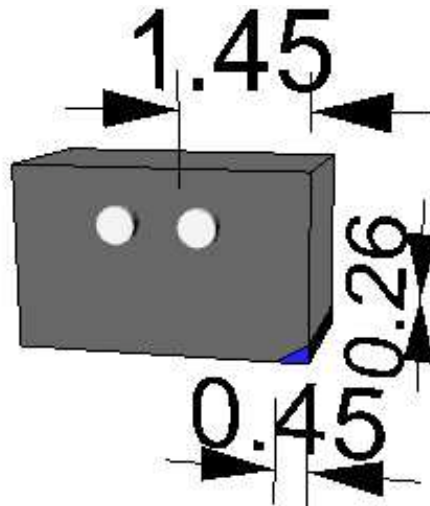

Figure 3.5

Now take the rubber block from figure 3.2 and measure 0.45" from the same side you measured from before, the right side, and measure 0.26" from the bottom, opposite the holes. Draw a line connecting these two points and cut the corner off along this line. Refer to figure 3.4 above.

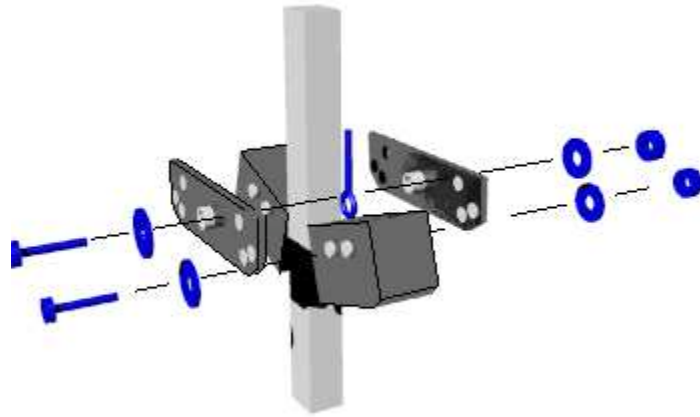

Figure 3.6

Grab both plates, both rubber blocks, and all the bolts, washers, and the nuts. Slide on a plate on either side making sure you stick it through the center hole with the PVC fitted on. Now stick the rubber blocks in between the two plates so the holes line up with the bottom two holes on the plates and the corner you cut off is on the lower side and pointing out. Slide a bolt through the four bottom holes of the plate with a washer up against the head of the bolt. Then put a washer on the very end of the bolt where it comes out the other side and fasten it with a nut. Now slide the top bolt through with a washer on it and going through the eye hook in between the two plates and then through the other plate where it is fastened with a washer and nut. Refer to figure 3.6 above for the order of assembly.

Treadle Pivot System



(x2)

Figure 3.7

Take two blocks of wood, 4" by 4" by 4" and drill a hole of diameter equal to the outside diameter of a PVC pipe with an inside diameter of 1 ¼" in the middle of the two blocks.

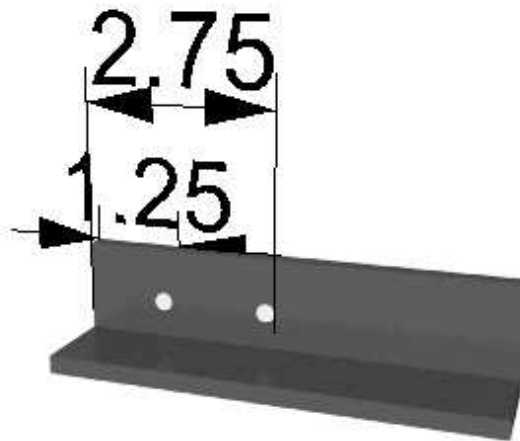

(x2)

Figure 3.8

Drill two holes a ¼" in diameter, for a couple bolts, in the four ¼" thick, 1 ½" wide and 6" long angle pieces on both of the flat sides. One of the holes centers should be 1 ¼" from the end and the other should be 2 ¾" from the same end and should be ¾" from the edge of the angle piece. Refer to figure 3.8 above.

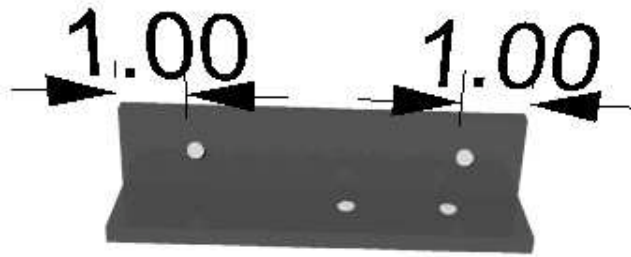

(x2)

Figure 3.9

Now drill two more holes in the four angle pieces from figure 3.8 but on the side of the angle piece that you didn't already drill into. The holes should be 0.25" in diameter and roughly 1" from either end and half way from the top to the bend of the angle piece. Refer to figure 3.9 above.



(x2)

Figure 4.0

Press feed the 1 ¼" diameter, 4" long PVC pipe into two of the blocks of wood. Do the same thing with the other two.



(x2)

Figure 4.1

Now take two of the 6" angle pieces from figure 3.9 with the holes drilled in them and bolt them on either side of the blocks so that they are aligned with each other and one edge is flush with the end of the blocks. Do the same thing for the other block and angle pieces. Refer to figure 4.1 above.

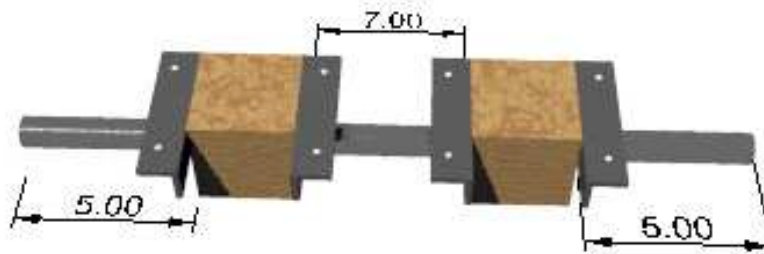

Figure 4.2

Now slide them on the 1 ¼" in diameter, 29" long steel rod with a PVC pipe of diameter 1 ¼" and length 7" separating the two blocks. Make sure that the angle pieces have a flat side pointing up and the longer edge is pointing to the tall square channel with the handle on it. Also slide on PVC pipe of diameter ¼" and length 5" on the ends of the pipe. Refer to figure 4.2 above.



Figure 4.3

Now slide the pipe through the holes of the square channels from figure 1.8, keeping everything on the rod in the same order as it is now. Refer to figure 4.3 above for correct order. Now securely weld the rod to the square channels at the ends. Later after the rest of the pump is assembled we will attached the treadles to the angle pieces.

Assembled thus far...



Figure 4.4: Frame with rocker-arm and treadle pivot system

Seal Assembly

Piston Seals



Materials:

Leather discs x 4:

5 in. diameter with a 3/8 in. Hole in the center. Leather should be about 1/4 in. thick, the more pliable and higher quality the better. The kind of leather used for tooling is best.

Plastic discs:

With 3/8" hole in the center. Some of 4" diameter to fit inside pipe, some of 3.5" diameter. These will be used later to construct the pistons.



Mold:

Section of 4 in. diameter PVC, about 2.5 in. long. One end should be beveled towards the inside to help the leather go in without ripping.



Base plate:

A strong piece of wood or metal with a 3/8 in. hole drilled. Should be 4" by 4" or larger

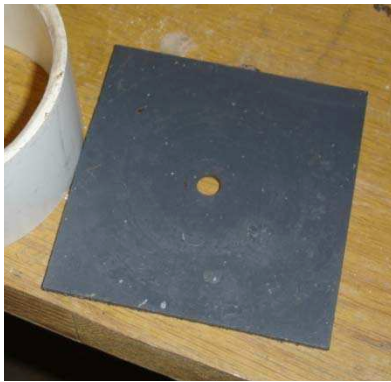

3/8 in. threaded rod

Nuts, Bolts, and washers: 2 of each.

Steps:

1. Soak the leather discs in room temperature water for about 5 minutes. The leather will become pliable.
2. Put a nut and washer on the threaded rod. Put the rod through the base plate. Set the pipe on the other side of the base plate so that it is centered around the rod (Note that in picture on left the table is used as the base plate). Place a few of the 4" discs in the bottom of the mold to help prevent the leather from popping out of the bottom.



4. After the first leather disc is finished soaking, put the leather disc onto the threaded rod so that it is resting on the PVC pipe section. Place a few 3.5" plastic discs on top of the leather. The combined thickness of the discs should be about 1/2". Put the washer and nut onto the rod.



5. Tighten the top nut forcing the leather into the mold. Keep tightening until the leather is pressed level to the base plate.

6. Let the seals dry in the mold. This will take several hours.

Pump Assembly

Schematic:

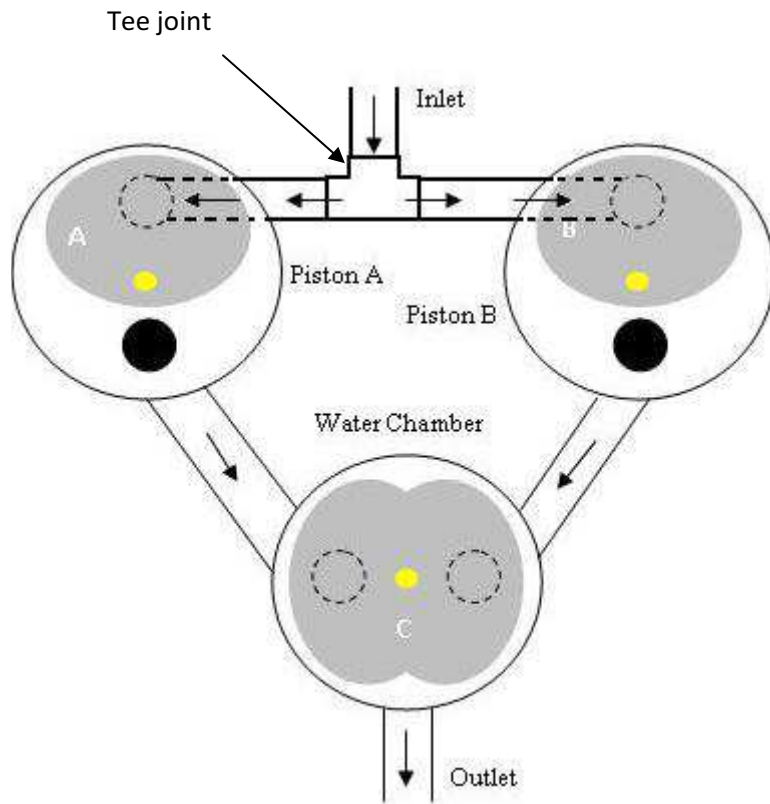

LEGEND	
	Water Flow
	Connecting Tubes
	Open Hole
	Covered (Inlet) Hole
	Flap
	Screws
	PVC Caps

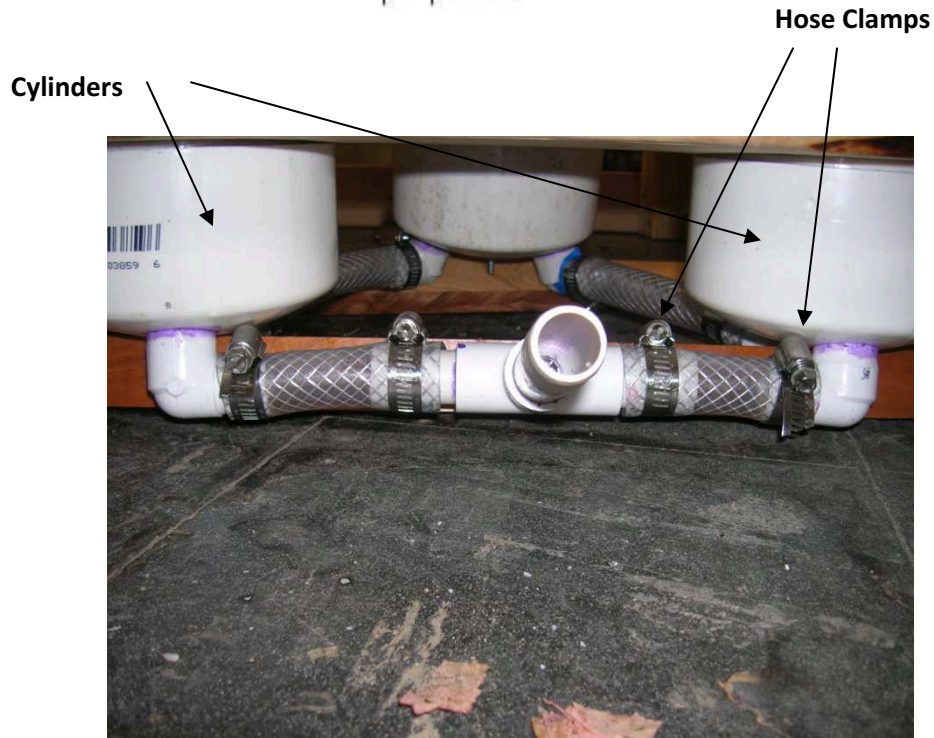

Water Chamber



Materials:

4" PVC Pipe

PVC Primer and Cement

3 x 4" End Caps, unthreaded

1 PVC Tee joint*

7 x PVC 90 degree elbows*

Rubber or plastic hose*

*These parts should have a diameter of $\frac{3}{4}$ " or 1". They need to have the same diameter since they will be used to connect the parts to each other. The hose should fit on the PVC parts. PVC parts can be sanded down to fit hose.

9x Hose clamps may be necessary to hold the hose onto the PVC elbows and the tee Joint.

4" Cleanout with threaded plug:



Thin rubber, such as an old inner tube

3 Small screws or bolts, with optional washers

Steps:

1. Cut the PVC into 2 sections 15.5" long. These will be the cylinders. Bevel one end of each towards the inside. This will make it easier to insert the pistons.

Create Cylinder A:

2. Take two of the elbows. File or sand one end of each so it is tapered.
3. Drill 2 holes opposite each other in one of the end caps. The diameter of the hole should be slightly less than the width of the elbow. Photo of inside of cylinder, flap rotated to show inlet hole:



4. Use the PVC primer and cement to glue the tapered end of the elbows into the holes. The elbows should extend to the outside of the cap, not the inside. The elbows should be at an angle to each other, as shown by the pipe directions in the schematic. If the end of the elbow extends past the inside surface of the end cap, sand it down so that it is flush with the surface of the cap. Here is a top view of the Piston B end cap, and a photo of the result:

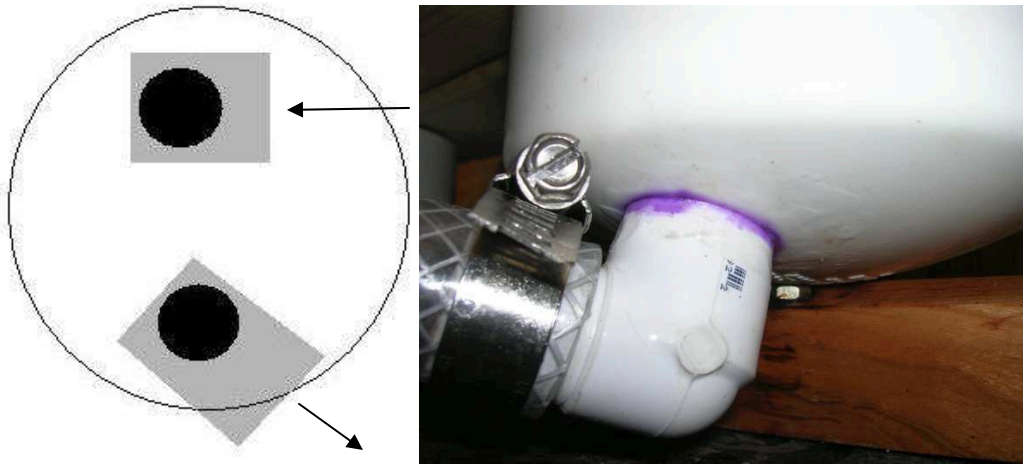

5. Cut a flap of the thin rubber to fit half of the end cap. This flap will cover the inlet hole to the cylinder and serve as a one-way valve. It should be as large as possible, but be clear of the sides of the end cap (to avoid pinching the flap between the cap and the cylinder). See picture from step 3.
6. Use a small screw or bolt to fasten the flap down in the center of the cap. You could put a small washer down on top of the flap, but it is not necessary. This will help hold down the flap.
7. Use the PVC primer and cement to glue the cap onto the unbeveled end of the cylinder.

Create Cylinder B End Cap

8. Repeat steps 2-7 but mirror the directions of the elbows:

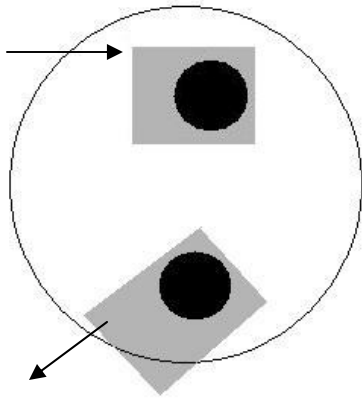

Create the Water Chamber

First make the water chamber end cap. The process is almost just like making the cylinder end caps.

9. File or sand 3 of the elbows so that one end of each is tapered (like in step 2).
10. Drill two holes opposite each other on the remaining end cap. As in step 3, the diameter of the hole should be slightly less than the width of the elbow.
11. Use the PVC primer and cement to glue the tapered end of the elbows into the holes. The elbows should be angled to meet the outlet elbows of the cylinders, as is shown in the schematic. If the end of the elbow extends past the inside surface of the end cap, sand it down so that it is flush with the surface of the cap.



12. Cut a flap of the thin rubber to fit the end cap. This flap will cover both inlet holes and serve as a one-way valve. It should be as large as possible, but be clear of the sides of the cap (to avoid pinching the flap between the cap and the cylinder).
13. Use a small screw or bolt to fasten the flap down in the center of the cap. You could put a small washer down on top of the flap, but it is not necessary. This will help hold down the flap.

14. Cut a short section of PVC. This section just needs to be long enough to hold the cleanout and the end cap. Depending on the cleanout, you may be able to attach the end cap directly to the cleanout. If this is possible, skip this step.
15. Use the PVC primer and cement to glue the end cap and the cleanout to the PVC section (or if possible glue the end cap directly to the cleanout). The chamber should be as short as possible.
16. Drill the outlet hole in the side of the chamber. The hole diameter should be slightly less than the width of the elbow. Avoid drilling the hole at the intersection of the end cap and the cleanout. This could cause the parts to separate. Also make sure not to drill into the plug, or no water will flow out.
17. Use the PVC primer and cement to glue the third elbow you filed into the hole.
18. Attach the components together with the hose as shown in the schematic. If necessary, use the hose clamps to hold the hoses onto the components and make a tight seal.

Piston Assembly

Materials:

Leather Seals (already produced)

3.5" and 4" diameter plastic discs used to make seals

3/8" Threaded rod

Threaded connector

Eye hooks x2

These may need to be manufactured. The straight part will need to be long enough to run all the way through the treadle (4 inches). They will need to be threaded. The eyes will also need to be hooked together, which will require bending.

3 Nuts and 4 Washers

A spacer such as a length of 2" diameter PVC to help stabilize the piston. This spacer has to be cut so that the piston assembly is no longer than 3 inches (from lowest part of bottom seal to top of top seal).

Directions:

1. Attach one eye hook to the treadle. Drill a vertical hole in the treadle. Run the straight shaft of the eye hook through the treadle. Tighten a washer and nut onto the threaded end of the hook.

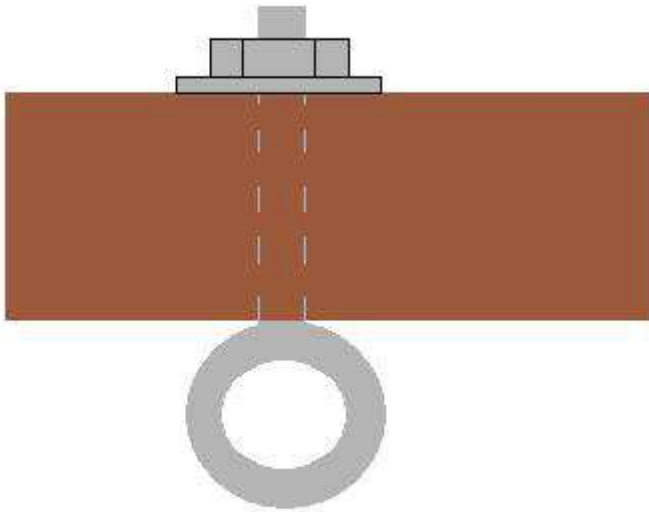

2. Put the remaining parts on the threaded rod in the following order:

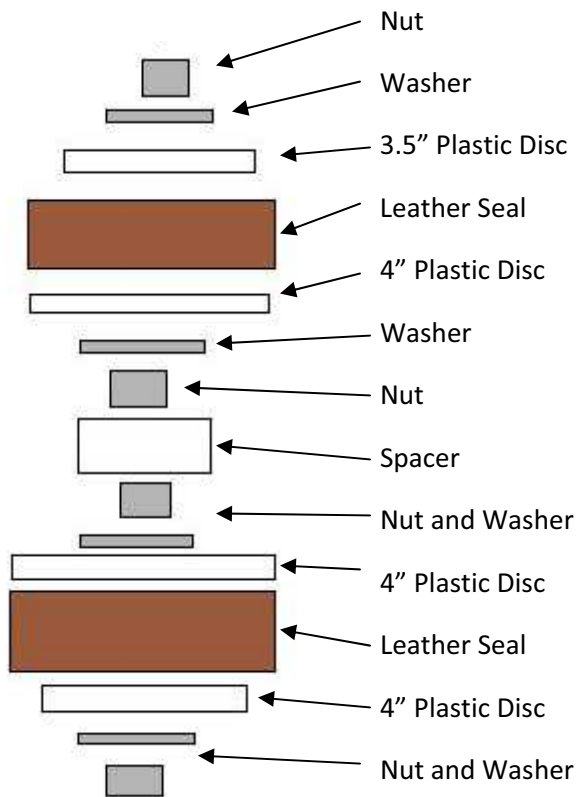

The top seal should be cupped upwards and the lower seal should be cupped downwards. The 3.5" diameter circles should sit inside the cup of the seals.

3. Use the threaded connector to attach the second eye hook to the threaded rod.
4. Hook the eye hooks together, attaching the piston to the treadle.
5. The bottom of the lowest seal must hang 15.5" below the treadle to avoid hitting the bottom of the cylinder. The piston must be 3 inches long from the top of the top seal to the bottom of the lower seal. Saw the threaded rod off right below the bottom nut.

Attaching the Pump to the Frame

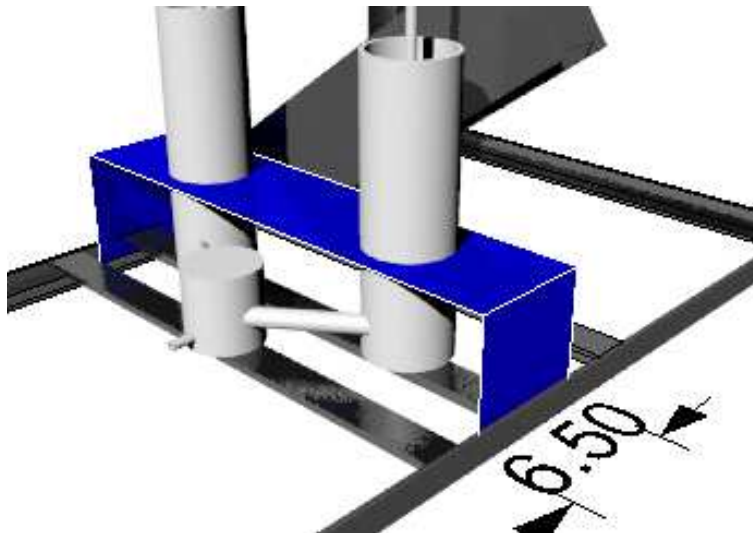

Figure 4.5

To attach the pump system to the frame set the cylinders on the t-shaped bar running across the pump, and the smaller out-going cylinder on the t-shaped bar facing the open end of the pump. Refer to Figure 4.5 above. Cut two holes in the sheet metal 4" in diameter, 17" from each end and 3.25" from the top. Then take the sheet metal and make two 90 degree bends, both going the same way, 7" from each end. Fit the sheet metal over the two cylinders with the bends facing down, and drill two holes in the frame and sheet metal on each side to secure the sheet metal to the frame.

Attaching the Treadles to the Frame

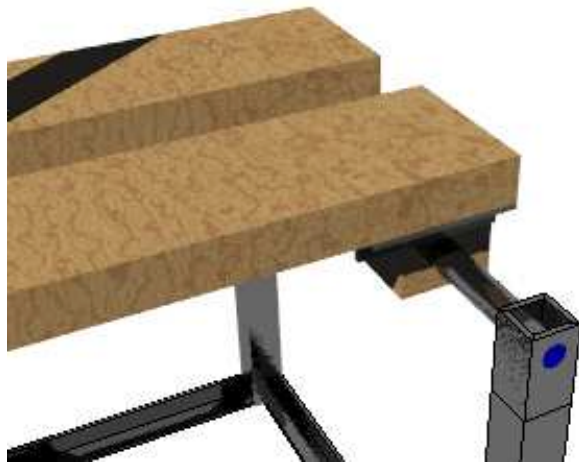

Figure 4.6

All you have to do to attach the treadles is lay it flat against the blocks of wood on the rod on the back of the pump. Make sure the block is centered in the middle of the 2" by 6" treadle and the end of the treadle and the end of the block are even. Now bolt the treadle to the block using the holes you drilled in the angle pieces. Make sure to put the washers on the bolt first.

Treadle Maintenance

If a treadle breaks than all you have to do is disconnect it from the pivot points, the wood blocks on the rod at the back of the pump, and from the pistons and simply reconnect a new board.

Seal maintenance:

1. Lubricate the piston seals with vegetable shortening (such as Crisco) or vegetable oil.
2. After using the pump, removing the pistons from the cylinders will help the cylinders dry and prevent rot. However, doing this may allow the lower seal to flare out and make it difficult to put the pistons back in the cylinder. One solution would be to remove the piston almost completely from the cylinder, leaving the very bottom of the bottom seal in the top of the cylinder. This will allow the seals to dry but make sure the bottom seal holds its shape.
3. The seals may eventually begin to rot. When the seal rots, it will need to be replaced. Customers should be able to manufacture replacements by attaching a wet leather disc to the piston (in the position of the top seal), and forcing it into the cylinder as though the pump is about to be used.

Cylinder Maintenance:

The one way valve flaps may eventually become worn or break. A new flap could easily be cut from an old inner tube or other scrap of thin rubber. The plug of the water chamber can be unscrewed for easy access.

Broken Elbows can be repaired with PVC primer and cement.