



# Rainwater Harvesting

## Introduction

A sufficient, safe drinking water supply is essential to life. However, millions of people throughout the world still do not have access to this basic necessity. After decades of work by governments and organisations to bring potable water to the poorer people of the world, the situation is still dire. The reasons are many and varied, but generally speaking, the poor of the world cannot afford the capital intensive and technically complex traditional water supply systems. Unfortunately these technologies are widely promoted by governments and agencies throughout the world. Rainwater harvesting (RWH) is an alternative to these unaffordable options. It has been adopted in many areas of the world where conventional water supply systems have not been provided, too expensive or failed to meet people's needs. RWH is a proven technology that has been in use since ancient times.

Examples of RWH systems can be found throughout history. In industrialised countries, sophisticated RWH systems have been developed to reduce water bills or to meet the needs of remote communities or individual households in arid regions. RWH is also used in developing countries. In Uganda and Sri Lanka, for example, rainwater is traditionally collected from trees, using banana leaves or stems as temporary gutters. Up to 200 litres may be collected in this way from a large tree in a single storm. Many individuals and groups have taken the initiative and developed a wide variety of RWH systems throughout the world.

Many kinds of rainwater harvesting are practised throughout the world. Basically RWH may be divided into two types:

- **Domestic RWH**
- **RWH for agriculture, erosion control, flood control and aquifer replenishment**

Domestic RWH is a simple mechanism to collect and store rainwater mainly for drinking and cooking. It may be household based or community based. The system uses a collection surface such as a roof, gutters to guide the rainwater, and a container to store the water.

Larger RWH systems are used for water resource management. These systems use vast catchment areas to collect rainwater and store it in reservoirs. The water is then used for irrigation or to recharge aquifers. These systems may also help in flood control and erosion prevention by holding storm water into reservoirs and discharging at a controlled rate.

This paper involves domestic RWH only. We must remember that rainwater harvesting is not the ultimate answer to household water problems. Many factors have to be considered when selecting the appropriate water source. These include cost, climate, hydrology, social and political elements, as well as technology. All of these play a role in making the final choice of a suitable water supply scheme. RWH is only one of many possible choices. But RWH is often overlooked by planners, engineers and builders.

The reason that RWH is rarely considered is often due to barriers such as lack of technical and other information. In many areas where RWH has been introduced as a part of drinking water supply options, it was at first un-popular. This was simply because little was known about the technology by the beneficiaries. In most of these cases, the technology has quickly gained popularity. The users soon realised the benefits of a clean, reliable water source at the home. This is especially true in areas where the town supply is unreliable or where local water sources dry up for a part of the year. In many cases RWH has also been introduced as a part of an integrated water supply system. It is a technology that is flexible and adaptable to a very wide variety of conditions. RWH is used in the richest and the poorest societies on our planet, and in the wettest and the driest regions of the world.

## Components of a domestic RWH system

Domestic RWH systems (DRWH) vary in complexity. Some of the traditional Sri Lankan systems are no more than a pot situated under a piece of cloth or a plastic sheet tied to four poles. The cloth captures the water and diverts it through a hole in its centre into the pot. In contrast, some of the sophisticated systems manufactured in Germany incorporate clever computer management systems, submersible pumps, and links to grey water and domestic plumbing system mains. Somewhere between these two extremes, we find the typical DRWH system in use in developing countries. Such a system will usually comprise a collection surface (a clean roof or ground area), a storage tank, and guttering to transport the water from the roof to the storage tank. Other peripheral equipment is sometimes incorporated, for example: first-flush systems to divert the dirty water which contains roof debris after prolonged dry periods; filtration equipment and settling chambers to remove debris and contaminants before water enters the storage tank or cistern; handpumps for water extraction; water level indicators, etc.

## Typical domestic RWH systems

A typical domestic RWH consists of a collection surface, gutters and a storage container. In addition, there are options for diverting first-flush water and filtration.

### Collection surfaces



**Figure 1:** A typical corrugated iron sheet roof, showing guttering. Photo: Practical Action

For domestic rainwater harvesting the most common surface for collection is the roof of the dwelling. Many other surfaces can be, and are, used: courtyards, threshing areas, paved walking areas, plastic sheeting, trees, etc. In some cases, as in Gibraltar, large rock surfaces are used to collect water which is then stored in large tanks at the base of the rock slopes.

The style, construction and material of the roof affect its suitability as a collection surface for water. Typical materials for roofing include corrugated iron sheet (also known

as tin roof), asbestos sheet; tiles (a wide variety is found), slate, and thatch (from a variety of organic materials). Most thatch are suitable for collection of rainwater, but only certain types of grasses e.g. coconut and anahaw palm (Gould and Nissen Peterson, 1999), thatched tightly, provide a surface adequate for high quality water collection. The rapid move towards the use of corrugated iron sheets in many developing countries favours the promotion of RWH.

## Guttering

Guttering is used to transport rainwater from the roof to the storage vessel. Guttering comes in a wide variety of shapes and forms, ranging from the factory made PVC type to home-made guttering using bamboo or folded metal sheet (Figure 1). Guttering is usually fixed to the building just below the roof and catches the water as it falls from the roof. Some common types of guttering and fixings are shown in Figure 2:

### Manufacture of low-cost gutters

Factory-made gutters are usually expensive and beyond the reach of the poor people of developing countries, if indeed available at all in the local marketplace. They are seldom used for very low-cost systems. The alternative is to make gutters from materials that can be found cheaply in the locality. There are a number of techniques that have been developed to help meet this demand; one such technique is described below.

V- shaped gutters from galvanised steel sheet can be made simply by cutting and folding flat galvanised steel sheet (Figure 3a). Such sheet is readily available in most market centres (otherwise corrugated iron sheet can be beaten flat) and can be worked with tools that are commonly found in a modestly equipped workshop. One simple technique is to clamp the cut sheet between two lengths of straight timber and then to fold the sheet along the edge of the wood. A strengthening edge can be added by folding the sheet through 90° and then completing the edge with a hammer on a hard flat surface. The better the grade of steel sheet that is used, the more durable and durable the product. Fitting a downpipe to V-shaped guttering can be problematic and the V-shaped guttering will often be continued to the tank rather than changing to the customary circular pipe section downpipe. Methods for fixing gutters are shown in Figure 3a.

Plastic pipes may be cut into half to make gutters (Figure 3b). This requires only a saw and some clamps to fix the half-pipes to roofs. It may be made quickly and cheaply in areas where plastic pipes are available.

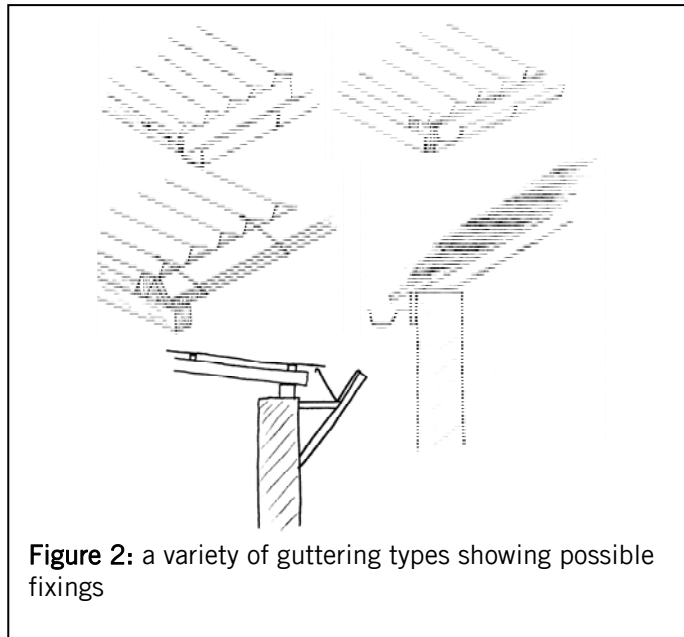

Figure 2: a variety of guttering types showing possible fixings

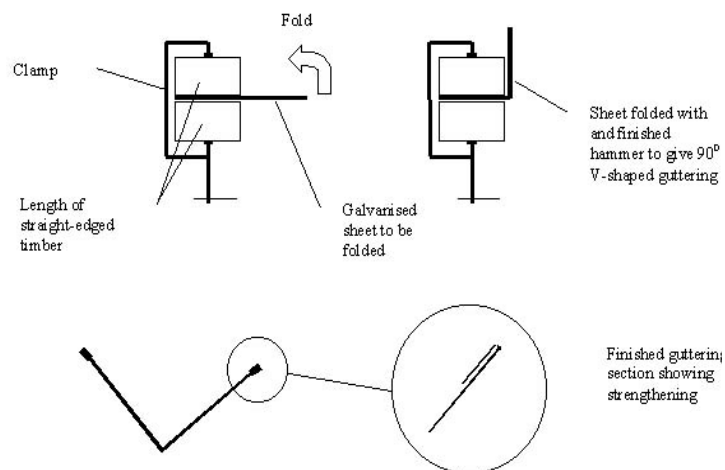

Figure 3a: folding galvanised steel sheet to make V-shaped guttering

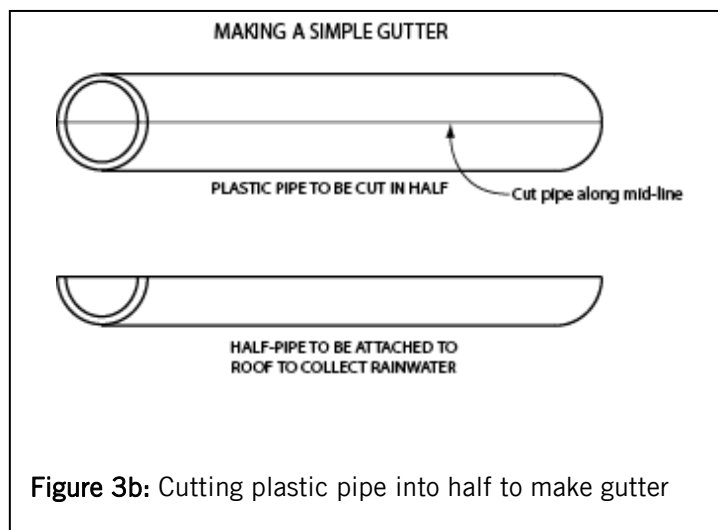

Figure 3b: Cutting plastic pipe into half to make gutter

### Storage tanks and cisterns

The water storage tank usually represents the biggest capital investment element of a domestic RWH system. It therefore requires careful design to provide optimal storage capacity while keeping the cost as low as possible. The catchment area is usually the existing rooftop or occasionally a cleaned area of ground, as seen in the courtyard collection systems in China. The guttering for the system can often be obtained relatively cheaply, or can be manufactured locally.

There are an almost unlimited number of options for storing water. Common vessels used for very small-scale water storage in developing countries include plastic bowls and buckets, jerrycans, clay or ceramic jars, cement jars, old oil drums, empty food containers, etc. For storing larger quantities of water, the system will require a tank or a cistern. For the purpose of this document, we will classify the tank as an above-ground storage vessel and the cistern as a below-ground storage vessel. These can vary in size from a cubic metre or so (1000 litres) up to hundreds of cubic metres for large projects. The typical maximum size for a domestic system is 20 or 30 cubic metres. The choice of system will depend on a number of technical and economic considerations listed below.

- Space availability
- Options available locally
- Local traditions for water storage
- Cost of purchasing new tank
- Cost of materials and labour for construction
- Materials and skills available locally
- Ground conditions
- Use of RWH – whether the system will provide total or partial water supply

One of the main choices will be whether to use a tank or a cistern. Both tanks and cisterns have their advantages and disadvantages. **Table 1** summarises the pros and cons of each:

	Tank	Cistern
<b>Pros</b>	<ul style="list-style-type: none"> <li>• Above ground structure allows easy inspection for leakages</li> <li>• Many existing designs to choose from</li> <li>• Can be easily purchased ‘off-the-shelf’</li> <li>• Can be manufactured from a wide variety of materials</li> <li>• Easy to construct from traditional materials</li> <li>• Water extraction can be by gravity in many cases</li> <li>• Can be raised above ground level to increase water pressure</li> </ul>	<ul style="list-style-type: none"> <li>• Generally cheaper due to lower material requirements</li> <li>• Not vulnerable to water loss by tap left open</li> <li>• Require little or no space above ground</li> <li>• Unobtrusive</li> <li>• Surrounding ground gives support allowing lower wall thickness, and thus lower costs</li> </ul>
<b>Cons</b>	<ul style="list-style-type: none"> <li>• Require space</li> <li>• Generally more expensive</li> <li>• More easily damaged</li> <li>• Prone to attack from weather</li> <li>• Failure can be dangerous</li> </ul>	<ul style="list-style-type: none"> <li>• Water extraction is more problematic, often requiring a pump</li> <li>• Leaks are more difficult to detect</li> <li>• Contamination of the cistern from groundwater is more common</li> <li>• Tree roots can damage the structure</li> <li>• There is danger to children and small animals if the cistern is left uncovered</li> <li>• Flotation of the cistern may occur if groundwater level is high and the cistern is empty.</li> <li>• Heavy vehicles driving over a cistern can cause damage</li> </ul>

technical brief

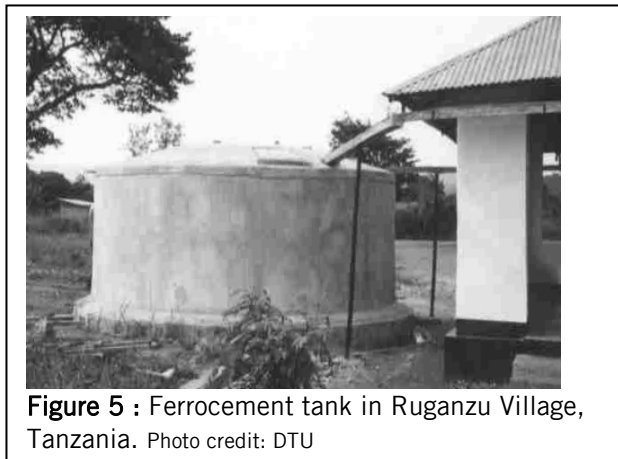

**Figure 4a:** An owner-built brick tank in Sri Lanka

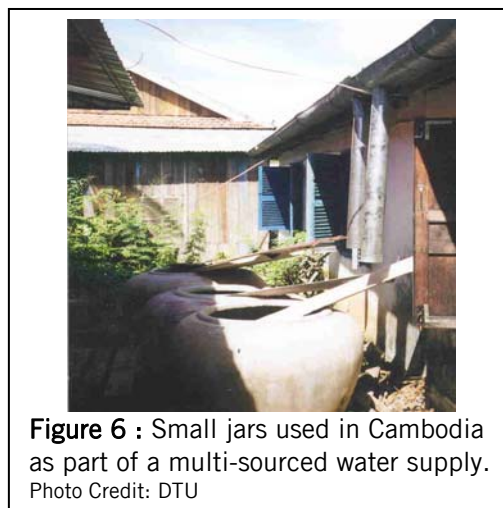

**Figure 4b:** A corrugated iron RWH tank in Uganda

Much work has been carried out to develop the ideal domestic RWH tank. The photographs (Figures 4-6) illustrate the variety of tanks that have been built in different parts of the world.



**Figure 5 :** Ferrocement tank in Ruganzu Village, Tanzania. Photo credit: DTU



**Figure 6 :** Small jars used in Cambodia as part of a multi-sourced water supply. Photo Credit: DTU

### First-flush systems

Debris, dirt, dust and droppings will collect on the roof of a building or other collection area. When the first rains arrive, this unwanted matter will be washed into the tank. This will cause contamination of the water and the quality will be reduced. Many RWH systems therefore incorporate a system for diverting this ‘first flush’ water so that it does not enter the storage tank.

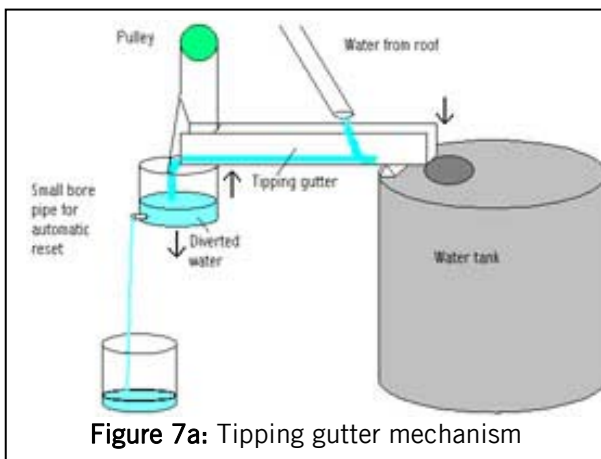

**Figure 7a:** Tipping gutter mechanism

The simpler ideas are based on a manually operated arrangement whereby the inlet pipe is moved away from the tank inlet, and then replaced again once the initial first flush has been diverted. This method has obvious drawbacks because there has to be a person present who will remember to move the pipe.

Other systems use tipping gutters to achieve the same purpose. The most common system (as shown in Figure 7a) uses a bucket which accepts the first flush and the weight of this water off-

balances a tipping gutter which then diverts the water back into the tank.

The bucket then empties slowly through a small-bore pipe and automatically resets. The process will repeat itself from time to time if the rain continues to fall, which can be a problem where water is really at a premium. In this case a tap can be fitted to the bucket and will be operated manually. The quantity of water that is flushed is dependent on the force required to lift the guttering. This can be adjusted to suit the needs of the user.

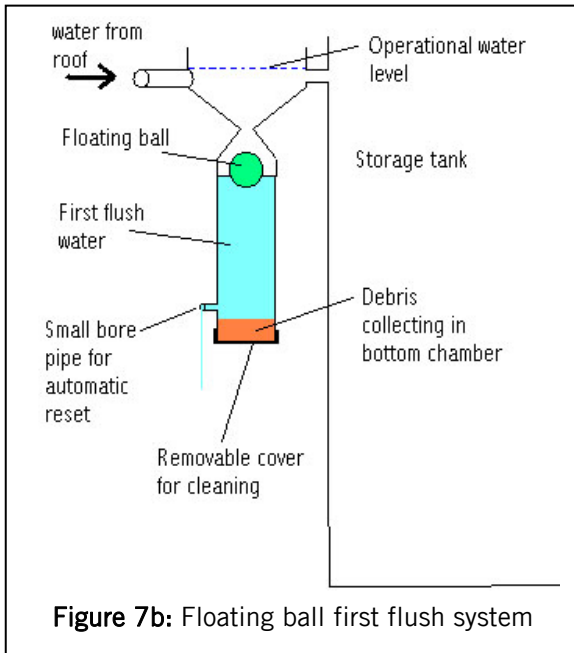

**Figure 7b:** Floating ball first flush system

Another system relies on a floating ball that forms a seal once sufficient water has been diverted (see Figure 7b). The seal is made as the ball rises into the apex of an inverted cone. The ball seals the top of the ‘waste’ water chamber and the diverted water is slowly released, as with the bucket system above, through a small bore pipe. Again, the alternative is to use a tap. In some systems (notably one factory manufactured system from Australia) the top receiving chamber is designed such that a vortex is formed and any particles in the water are drawn down into the base of the vortex while only clean water passes into the storage tank. The ‘waste’ water can be used for irrigating garden plants or other suitable application. The debris has to be removed from the lower chamber occasionally.

Although the more sophisticated methods provide a much more elegant means of rejecting the first flush water, practitioners often recommend that very simple, easily maintained systems be used, as these are more likely to be repaired if failure occurs.

### Filtration systems and settling tanks

Again, there are a wide variety of systems available for treating water before, during, and after storage. The level of sophistication also varies from extremely high-tech to very rudimentary. A German company, WISY, have developed an ingenious filter which fits into a vertical downpipe and acts as both filter and first-flush system. The filter (Figure 8) cleverly takes in water through a very fine (~0.20mm) mesh while allowing silt and debris to continue down the pipe. The efficiency of the filter is over 90%. This filter is commonly used in European systems.

The simple trash rack has been used in some systems but this type of filter has a number of associated problems: firstly it only removes large debris; and secondly the rack can become clogged easily and requires regular cleaning. The sand-charcoal-stone filter is often used for filtering rainwater entering a tank. This type of filter is only suitable, however, where the inflow is slow to moderate, and will soon overflow if the

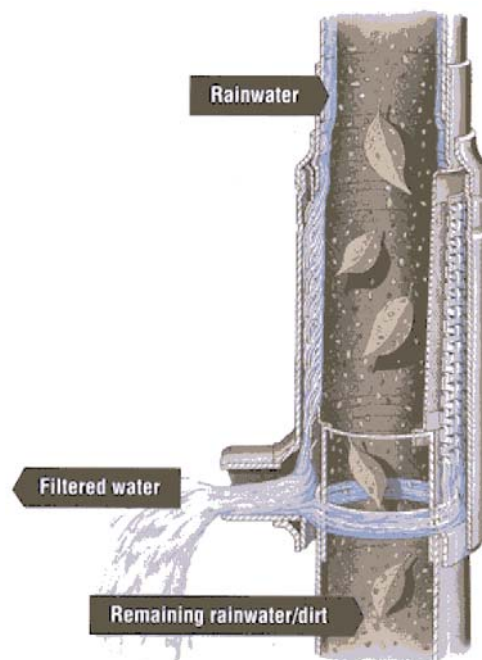

**Figure 8 :** the WISY filter (downpipe and high-capacity below ground versions)  
Source: WISY Catalogue

technical brief

inflow exceeds the rate at which the water can percolate through the sand. Settling tanks and partitions can be used to remove silt and other suspended solids from the water. These are usually effective, but add significant additional cost if elaborate techniques are used. Many systems found in the field rely simply on a piece of cloth or fine mosquito mesh to act as the filter (and to prevent mosquitoes entering the tank).

Post storage filtration include such systems as the upflow sand filter or the twin compartment candle filters commonly found in developing countries. Many other systems exist and can be found in the appropriate water literature.

### Sizing the system

Usually, the main calculation carried out by the designer when planning a domestic RWH system will be to size the water tank correctly to give adequate storage capacity. The storage requirement will be determined by a number of interrelated factors. They include:

- local rainfall data and weather patterns
- size of roof (or other) collection area
- runoff coefficient (this varies between 0.5 and 0.9 depending on roof material and slope)
- user numbers and consumption rates

The style of rainwater harvesting i.e. whether the system will provide total or partial supply (see the next section) will also play a part in determining the system components and their size.

There are a number of different methods used for sizing the tank. These methods vary in complexity and sophistication. Some are readily carried out by relatively inexperienced, first-time practitioners while others require computer software and trained engineers who understand how to use the software. The choice of method used to design system components will depend largely on the following factors:

- the size and sophistication of the system and its components
- the availability of the tools required for using a particular method (e.g. computers)
- the skill and education levels of the practitioner / designer

Outlined below are two different methods for sizing RWH system components.

#### ***Method 1 : demand side approach***

A very simple method is to calculate the largest storage requirement based on the consumption rates and occupancy of the building.

As a simple example we can use the following typical data:

Consumption per capita per day,  $C = 20$  litres  
 Number of people per household,  $n = 6$   
 Longest average dry period = 25 days  
 Daily consumption =  $C \times n = 120$  litres  
 Storage requirement,  $T = 120 \times 25 = 3,000$  litres

This simple method assumes sufficient rainfall and catchment area, and is applicable in areas where this is the situation. It is a method for acquiring rough estimates of tank size.

#### ***Method 2 : supply side approach***

In low rainfall areas or areas where the rainfall is of uneven distribution, more care has to be taken to size the storage properly. During some months of the year, there may be an excess of water, while at other times there will be a deficit. If there is enough water throughout the year to meet the demand, then sufficient storage will be required to bridge the periods of scarcity. As storage is expensive, this should be done carefully to avoid unnecessary expense.



This is a common scenario in many developing countries where monsoon or single wet season climates prevail.

The example given here is a simple spreadsheet calculation for a site in North Western Tanzania. The rainfall statistics were collected from a nurse at the local hospital who had been keeping records for the previous 12 years. Average figures for the rainfall data were used to simplify the calculation, and no reliability calculation is done. This is a typical field approach to RWH storage sizing.

The example is taken from a system built at a medical dispensary in the village of Ruganzu, Biharamulo District, Tanzania.

<p><b>Demand:</b>                  Number of staff: 6                  Staff consumption: 25 lpcd*                  Patients: 30                  Patient consumption: 10 lpcd                  Total daily demand: 450 litres</p>	<p><b>Supply:</b>                  Roof area: 190m<sup>2</sup>                  Runoff coefficient** (for new corrugated GI*** roof): 0.9                  Average annual rainfall: 1056mm per year                  Daily available water (assuming all is collected) = (190 x 1056 x 0.9)/ 365 = 494.7 litres</p>
--	---

\*lpcd : litres per capita per day

\*\* Run-off coefficient values vary between 0.3 and 0.9 depending on the material of the catchment area. It takes into consideration losses due to percolation, evaporation, etc.

\*\*\*GI : galvanized iron, in some countries, known as tin roof

It is seen that on the average the daily available rainwater is sufficient to meet the demand. However, we have to remember that rainfall does not occur uniformly throughout the year. We must collect and store enough water in the rainy season to last the dry months to ensure water availability throughout the year. The required volume of the storage tank may be found by examining monthly rainwater collection potential or supply (based on average monthly rainfall) against the demand. The cumulative shortfall in the dry months has to be met. In this example, there is very little rainfall in Jun, July and August and moderate rainfall in May and September in Tanzania. So we need to store about 115 days demand or about 52 cubic m (450X115=51,750 L or 51.75 cu m). This is a rough calculation for sizing the storage tank. Plotting actual rainfall data and demand in a cumulative manner can help in further refining the tank size.

### Rainwater quality and health

There are two main issues when looking at the quality and health aspects of DRWH: Firstly, there is the issue of *bacteriological water quality*. Rainwater can become contaminated by faeces entering the tank from the catchment area. It is advised that the catchment surface always be kept clean. Rainwater tanks should be designed to protect the water from contamination by leaves, dust, insects, vermin, and other industrial or agricultural pollutants. Tanks should be sited away from trees, with good-fitting lids and kept in good condition. Incoming water should be filtered or screened, or allowed to settle to take out foreign matter (as described in a previous section). Water which is relatively clean on entry to the tank will usually improve in quality if allowed to sit for some time inside the tank. Bacteria entering the tank will die off rapidly if the water is clean. Algae will grow inside a tank if sufficient sunlight is available for photosynthesis. Keeping a tank dark and sited in a shady spot will prevent algae growth and also keep the water cool. The area surrounding a RWH should be kept in good sanitary condition, fenced off to prevent animals fouling the area or children playing around the tank. Any pools of water gathering around the tank should be drained.

Secondly, there is a need to prevent insect vectors from breeding inside the tank. In areas where malaria is present, mosquito breeding in the storage tank can cause a major problem. All tanks should be sealed to prevent insects from entering. Mosquito proof screens should

be fitted to all openings. Some practitioners recommend the use of 1 to 2 teaspoons of household kerosene in a tank of water which provides a film to prevent mosquitoes settling on the water.

There are several simple methods of treatment for water before drinking.

- Boiling water will kill any harmful bacteria which may be present
- Adding chlorine in the right quantity (35ml of sodium hypochlorite per 1000 litres of water) will disinfect the water
- Slow sand filtration will remove any harmful organisms when carried out properly
- A recently developed technique called SODIS (SOlar DISinfection) utilises plastic bottles which are filled with water and placed in the sun for one full day. The back of the bottle is painted black. More information can be found through the Resource Section at the end of this document.

## Rainwater harvesting resources

### References and further reading

- *Runoff Rainwater Harvesting* Practical Action Technical Brief
- *The Sri Lankan 'Pumkin' Eater Tank ~ Case Study* Practical Action Technical Brief
- *The Underground Brick Dome Water Tank ~ Case Study* Practical Action Technical Brief
- *The Cement Mortar Jar ~ Case Study* Practical Action Technical Brief
- *Rainwater Catchment Systems for Domestic Supply*, by John Gould and Erik Nissen-Petersen, IT Publications Ltd., 1999. Summarises the state of the art at the moment.
- *Ferrocement Water tanks and their Construction*, S. B. Watt. 1978  
The classic text on construction of ferrocement tanks.
- *Rainwater Harvesting: The Collection of Rainfall and Runoff in Rural Areas*, Arnold Pacey and Adrian Cullis – a wider focus including the capture of runoff for agricultural use. IT Publications.
- *Water Harvesting – A Guide for Planners and Project Managers*, Lee, Michael D. and Visscher, Jan Teun, IRC International Water and Sanitation Centre, 1992
- *Water Harvesting in five African Countries*, Lee, Michael D. and Visscher, Jan Teun, IRC / UNICEF, 1990. As snapshot of the status of RWH in five African countries.
- *Waterlines Journal* Vol. 18, No 3, January 2000 and Vol. 14, No.2, October 1995 Both issues are dedicated to rainwater harvesting, available through ITDG Publishing,
- Photo-manuals by Eric Nissen-Petersen. A range of manuals on how to build a number of tank types including: cylindrical water tanks with dome, an underground tank, smaller water tanks and jars, installation gutters and splash-guards, available from the author at: P.O. Box 38, Kibwezi, Kenya.
- *Rainwater Catchment Systems – Reflections and Prospects*, John Gould, *Waterlines* Vol.18 No. 3, January 2000.
- *Domestic Water Supply Using Rainwater Harvesting*, by T.H.Thomas, Director of the Development Technology Unit (DTU), University of Warwick. The article is available on DTU's Website (see below).
- *Waterlines* back issues containing rainwater harvesting articles: Vols 17(3), 16(4), 15(3), 14(2), 11(4), 8(3), 7(4), 5(4), 5(3), 4(4), 4(3), 3(3), 3(2), 3(1), 2(4), 2(1), 1(1).

### Video

- *Mvua ni Maji – Rain is Water, Rainwater Harvesting* by Women's Groups in Kenya, FAKT, 1996. 27 min VHS/PAL. A Kenyan film team documented this success story on the occasion of the visit of a delegation of Ugandan women who came to learn the skills of rainwater harvesting from their Kenyan sisters. Available through FAKT (see address section)
- *A Gift from the Sky – An Overview of Roofwater Harvesting in Sri Lanka*. Available from the Lanka Rainwater Harvesting Forum (see address section).

- *Construction of Water Tanks for Rainwater Harvesting* – a video manual prepared by Eric Nissen-Petersen (see above).
- *Rock Catchments*. Several designs of rock catchment system looked at in detail. Again by Erik Niseen-Petersen.

## Useful contacts

**Development Technology Unit,  
School of Engineering,  
University of Warwick,  
Coventry CV4 7AL, UK.**

Email [dtu@eng.warwick.ac.uk](mailto:dtu@eng.warwick.ac.uk)

<http://www.eng.warwick.ac.uk/DTU/rainwaterharvesting/index.htm> - a number of case studies from around the world, with good descriptions.

Contact Dr Terry Thomas. Also the co-ordinators of the Rainwater Harvesting Research Group (RHRG)

### **International Rainwater Catchment Systems Association (IRCSA)**

Dept. of Natural Resources, Chinese Cultural University, Hwa Kang, Yang Min Shan, Taipei, Taiwan.

E-mail: [ufab0043@ms5hinet.net](mailto:ufab0043@ms5hinet.net)

Website: <http://www.ircsa.org/>

IRCSA Fact sheets <http://www.ircsa.org/factsheets.htm>

### **Lanka Rainwater Harvesting Forum (LRWF)**

c/o Practical Action South Asia,  
5 Lionel Eridisinghe Mawatha, Colombo 5, Sri Lanka

E-mail: [rwhf@itdg.lanka.net](mailto:rwhf@itdg.lanka.net)

Website: <http://www.rainwaterharvesting.com>

### **Centre for Science and Environment (CSE)**

41 Tughlakabad Institutional Area, New Delhi 110062, India

E-mail: [cse@cseindia.org](mailto:cse@cseindia.org)

### **People for promoting Rainwater Utilisation**

1-8-1 Higashi-Mukojima, Sumida City, Tokyo, Japan

E-mail [murase-m@tc4.so-net.ne.jp](mailto:murase-m@tc4.so-net.ne.jp)

### **IRC (The International Water and Sanitation Centre)**

PO Box 93190, 2509 AD

The Hague, Netherlands

E-mail: [general@irc.nl](mailto:general@irc.nl)

Website: <http://www.irc.nl>

### **Uganda Rain Water Association (URA),**

P. O. Box 20026, Kampala, Uganda.

E-mail: [wesacc.dwd@imul.com](mailto:wesacc.dwd@imul.com)

### **Kenya Rainwater Association**

P O Box 72387, Nairobi, Kenya

E-mail: [kra@net2000ke.com](mailto:kra@net2000ke.com)

### **United Kingdom Rainwater Harvesting Association**

Website: <http://www.ukrha.co.uk>

**The Pelican Tank Rainwater Collection System** - a packaged RWH collection system developed in Australia for use in developing countries  
<http://www.pastornet.net.au/worldview/ac.htm>

#### **SimTanka**

<http://www.geocities.com/RainForest/Canopy/4805/>

software for sizing reliable rainwater harvesting systems with covered storage tanks – SimTanka, is freely available.

#### **JRCSA (Japan Rainwater Catchment Association)**

<http://takeyam.life.shimane-u.ac.jp/jircsa/homepage.html>

#### **SA WATER (South Australian Water Corporation)**

<http://www.sacentral.sa.gov.au/agencies/saw>

#### **Centre for Science and the Environment (CSE)**

<http://oneworld.org/cse/html/cmp/cmp43.htm> -

Rainwater harvesting page - a very active Indian Group

#### **Sunstove**

<http://www.sungravity.com/index.html>

The Sunstove Organization's web site provides free instructions, photos, drawings and specifications to build a roof catchment system, sand filter, cement water tank, and spring capping systems

#### **Global Applied Research Network (GARNET)**

<http://info.lut.ac.uk/departments/cv/wedc/garnet/tncrain.html>

Site of the Global Applied Research Network (GARNET) Rainwater Harvesting Page –

<http://www.unep.or.jp/ietc/Publications/TechPublications/TechPub-8d/index.html#1> - link to a recent UNEP publication titled 'Sourcebook of Alternative Technologies for Freshwater Augmentation in Small Island Developing States' that includes some useful information on RWH

<http://www.unep.or.jp/ietc/Publications/TechPublications/TechPub-8e/index.html>

Sourcebook of Alternative Technologies for Freshwater Augmentation in Some Countries in Asia - another in this series of **UNEP publications**

#### **World Meteorological Organisation (WMO)**

<http://www.wmo.ch/>

<http://www.ufrpe.br/~debarros/APED/RWCpres/index.htm> - Rainwater Harvesting in the Loess Plateau of Gansu, China - a paper presented at the 9th **IRCSA** Conference in Brazil

<http://www.greenbuilder.com/sourcebook/Rainwater.html#CSI> - Sustainable Building Sourcebook Website

### **Information Centers**

#### **Asian Institute of Technology (AIT)**

P.O. Box 4

Khlong Luang Pathumthani 12120, THAILAND

Tel: (66-2) 529-0900-13; Direct Line: (66-2) 524-5864

Fax: (66-2) 516-2126 or (66-2) 524-5870

E-mail: [geoferro@ait.ac.th](mailto:geoferro@ait.ac.th)

Website: <http://www.ait.ac.th/clair/centers/ific>

Center for Library and Information Resources (CLAIR)

International Ferrocement Information Center (IFIC)

WELL

<http://www.lboro.ac.uk/well/resources/technical-briefs/36-ferrocement-water-tanks.pdf>

A technical brief on how to make a ferrocement water tank

Roofwater harvesting discussion forum

<http://www.jiscmail.ac.uk/lists/rwh.html>

*This technical brief was updated by Shafiul Ahmed for Practical Action, 2008.*

Practical Action  
The Schumacher Centre for Technology and Development  
Bourton-on-Dunsmore  
Rugby, Warwickshire, CV23 9QZ  
United Kingdom  
Tel: +44 (0)1926 634400  
Fax: +44 (0)1926 634401  
E-mail: [inforsew@practicalaction.org.uk](mailto:inforsew@practicalaction.org.uk)  
Website: <http://practicalaction.org/practicalanswers/>

Practical Action is a development charity with a difference. We know the simplest ideas can have the most profound, life-changing effect on poor people across the world. For over 40 years, we have been working closely with some of the world's poorest people - using simple technology to fight poverty and transform their lives for the better. We currently work in 15 countries in Africa, South Asia and Latin America.

technical brief