



Technical Report

NetApp and VMware View Solution Guide

Chris Gebhardt and Abhinav Joshi, NetApp
August 2010 | TR-3705

Version 4.5

ABSTRACT

This document provides NetApp best practices on designing, architecting, deploying, and managing a scalable VMware® View 4.X (VDI) environment on NetApp® storage.

TABLE OF CONTENTS

1	EXECUTIVE SUMMARY	4
1.1	IMPLEMENTING BEST PRACTICES	4
1.2	AUDIENCE	4
2	SCOPE	4
3	INTRODUCTION TO VMWARE VIEW	4
4	VMWARE VIEW POOLS	5
4.1	VMWARE VIEW DESKTOP DELIVERY MODELS	6
5	NETAPP SOLUTION AND COMPONENTS	7
5.1	SINGLE SCALABLE UNIFIED ARCHITECTURE	7
5.2	STORAGE EFFICIENCY	8
5.3	PERFORMANCE	10
5.4	OPERATIONAL AGILITY	11
5.5	DATA PROTECTION	14
6	NETAPP AND VMWARE VIEW DESKTOP POOLS	15
6.1	MANUAL DESKTOP POOL	16
6.2	AUTOMATED DESKTOP POOL	17
7	ACCELERATING VMWARE VIEW WITH READ AND WRITE I/O OPTIMIZATION	18
7.1	CONCEPTS	18
7.2	NETAPP WRITE OPTIMIZATION	19
7.3	BENEFITS OF TRANSPARENT STORAGE CACHE SHARING	19
7.4	DEDUPLICATION AND NONDUPLICATION TECHNOLOGIES	20
7.5	CACHING MODULES	21
7.6	TRADITIONAL AND TRANSPARENT STORAGE CACHE SHARING	21
7.7	SUMMARY OF TRANSPARENT STORAGE ARRAY CACHE IN A VMWARE VIEW ENVIRONMENT	27
7.8	SUMMARY	27
8	STORAGE SIZING BEST PRACTICES	28
8.1	GATHER ESSENTIAL SOLUTION REQUIREMENTS	28
8.2	PERFORMANCE-BASED AND CAPACITY-BASED STORAGE ESTIMATION PROCESS	29
8.3	GETTING RECOMMENDATIONS ON STORAGE SYSTEM PHYSICAL AND LOGICAL CONFIGURATION	38
9	STORAGE ARCHITECTURE BEST PRACTICES	38
9.1	STORAGE SYSTEM CONFIGURATION BEST PRACTICES	39
10	CONFIGURING VSC 2.0 PROVISIONING AND CLONING	41
11	DEPLOYING NETAPP SPACE-EFFICIENT VM CLONES	44
11.1	OVERVIEW OF DEPLOYING NETAPP SPACE-EFFICIENT CLONES	44
11.2	DETAILS OF DEPLOYING NETAPP SPACE-EFFICIENT CLONES	45

12 USING VSC 2.0 PROVISIONING AND CLONING REDEPLOY	60
13 VMWARE VIEW OPERATIONAL BEST PRACTICES	64
13.1 DATA DEDUPLICATION	64
13.2 ANTIVIRUS OPERATIONS.....	67
13.3 MONITORING NETAPP AND VMWARE VIEW INFRASTRUCTURE.....	67
13.4 DATA PROTECTION SOLUTION.....	68
14 SUMMARY	68
15 FEEDBACK.....	69
16 REFERENCES	69
17 ABOUT THE AUTHORS	70
18 ACKNOWLEDGEMENTS	70
19 VERSION HISTORY.....	71

1 EXECUTIVE SUMMARY

The NetApp solution enables companies to optimize their virtual infrastructures by providing advanced storage and data management capabilities. NetApp provides industry-leading storage solutions that simplify virtual machine (VM) provisioning; enable mass VM cloning and redeployment; handle typical I/O bursts, for example, boot storm, antivirus storms, efficient operating system (OS), application, and user data management, and so on; provide individual VM backup and restores; deliver simple and flexible business continuance; and help reduce virtual desktop storage.

This solution guide provides guidelines and best practices for architecting, deploying, and managing VMware View (VDI) solutions on NetApp storage systems. NetApp has been providing advanced storage features to VMware ESX-based solutions since the product began shipping in 2001. During that time, NetApp has continuously enhanced the design, deployment, and operational guidelines for the storage systems and ESX Server-based VDI solutions. These techniques have been documented and are referred to as best practices. This solution best practices guide describes them in detail.

1.1 IMPLEMENTING BEST PRACTICES

The recommendations and practices presented in this document should be considered deployment requirements unless otherwise stated. While not implementing all of the contained best practices does not affect one's ability to obtain support from NetApp and VMware, disregarding any of these practices commonly results in the need to implement them at a later date, on a much larger environment, and often with the requirement of application downtime. For these reasons we advocate that one implement all of the best practices as defined within this document as a part of one's initial deployment or migration.

All recommendations in this document apply specifically to deploying vSphere™ on NetApp. As such, the contents of this document supersede all recommendations and best practices expressed in other versions of TR-3705.

Note: Data ONTAP® Version 7.3.1P2 or greater is required to implement the NetApp vSphere plug-ins.

In addition to this document, NetApp and our partners offer professional services to architect and deploy the designs contained within this document. These services can be an attractive means to enable optimal virtual storage architecture for your virtual data center.

1.2 AUDIENCE

The target audience for this paper is familiar with concepts pertaining to VMware vSphere, including VMware ESX 4, VMware vCenter™ Server 4, and NetApp Data ONTAP 7.3.1P2 or greater. For high-level information and an overview of the unique benefits that are available when creating a virtual infrastructure on NetApp storage, see [Comprehensive Virtual Desktop Deployment with VMware and NetApp](#).

2 SCOPE

The scope of this document is to provide architectural, deployment, and management guidelines for customers that are planning or have already decided to implement VMware View on NetApp virtualized storage. It provides a brief overview of the VMware View technology concepts; key solution architecture considerations for implementing VMware View on NetApp; storage estimation and data layout recommendations; and solution, deployment, and management guidelines.

3 INTRODUCTION TO VMWARE VIEW

Corporate IT departments are facing a new class of desktop management issues as they strive to provide end users with the flexibility of accessing corporate IT resources using any device from any network. IT is also being asked to provide access to corporate resources for an increasingly dispersed and growing audience that includes workers in off-site facilities, contractors, partners, and outsourcing providers as well as employees traveling or working from home. All of these groups demand access to sensitive corporate resources, but IT must make sure of strict adherence to corporate security requirements and new regulatory standards.

VDI enables organizations to increase corporate IT control, manageability, and flexibility of desktop resources while providing end users with a familiar desktop experience. VMware View is an enterprise-class solution to deliver corporate PC services to end users. VMware View 4 solution components might include but are not limited to:

- Virtualization hypervisor (VMware ESX 4.0)
- Tool for centralized management, automation, provisioning, and optimization (VMware vCenter, NetApp VSC 2.0, VMware View Composer)
- Connection broker and desktop management (VMware View 4.5)
- Virtualized desktop images (Windows® XP, Windows Vista®, Windows 7, and so on)
- Enhanced Windows profile and data management solutions (for example, RTO Software and AppSense, Liquidware Labs ProfileUnity)
- Thin client/PC (for example, Wyse, DevonIT)

VMware View 4.5, based on the proven VMware vSphere virtualization platform, delivers unique desktop control and manageability, while providing end users with a familiar desktop experience without any modifications to the desktop environment or applications.

4 VMWARE VIEW POOLS

VMware has created the concept of desktop pools. Policies and entitlements are set for each pool such that all desktops within that pool follow the same provisioning, login/logoff behavior, display, data persistence, and patching rules. The two types of desktops are manual and automatic pools. For any customer environment, these pooled desktops can be classified as either dedicated or floating.

- **Dedicated (persistent) desktops:** Dedicated desktops can be defined as desktops that are permanently assigned to a single user and are customizable; no other user is entitled to use such a desktop. The user logs into the same desktop every day, and the changes made to the system image (new data, applications, registry changes) are saved across login sessions and reboots. This is exactly like a traditional laptop or desktop, with all the customizations and personal data stored locally on the C drive. This model might, however, include the use of CIFS home directories and/or profile redirection for better user data and profile management. This is a common type of VDI deployment model that is used today for knowledge workers, mobile workers, and power users and is a major driver for increased shared storage requirement.
- **Floating (nonpersistent) desktops:** Floating desktops can be defined as desktops that are not assigned to a specific user. The user could get assigned to a different virtual desktop at every login. This deployment model could be used for task workers or shift workers (for example, call centers workers, tellers, students, or medical professionals) and some knowledge workers who require little control of their desktops.

One might choose to implement either of these models or a mix based on the business requirements, types of users, and proportion of users represented by different job functions.

4.1 VMWARE VIEW DESKTOP DELIVERY MODELS

[VMware View Manager](#) is the VMware virtual desktop management solution that improves control and manageability and provides a familiar desktop experience.

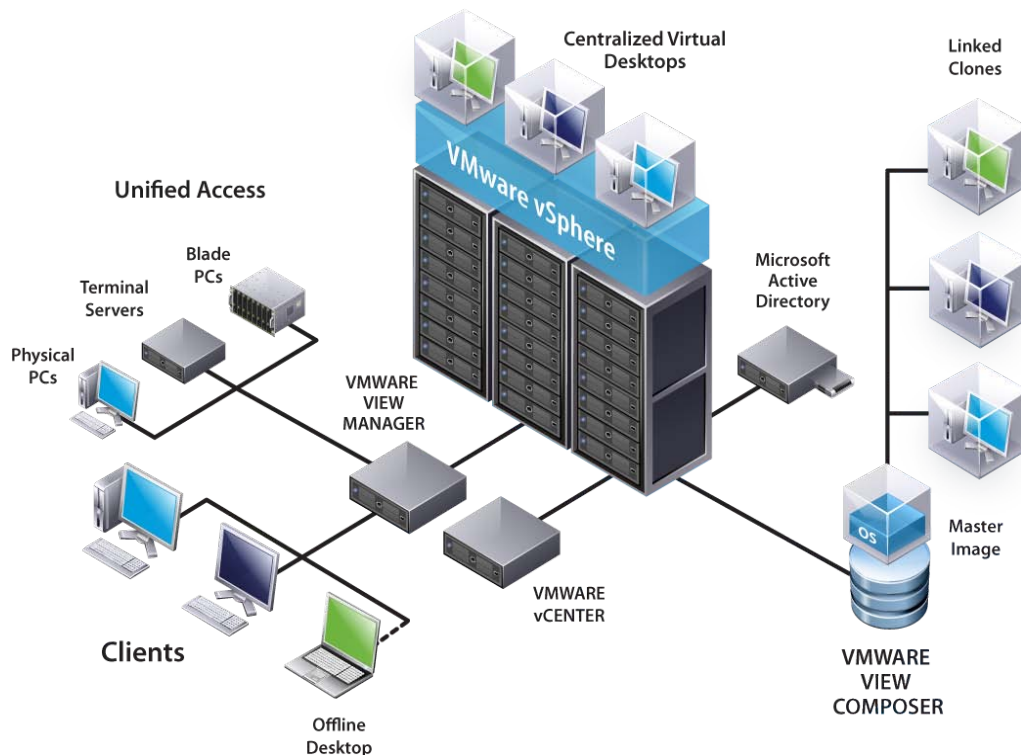

Figure 1) VMware View features (source: VMware).

At a high level, there are multiple pool types in VMware View:

- **Manual desktop pools:** This pool type provides the assignment of multiple users to multiple desktops, with only one active user on a desktop at a time. These types of desktops must be **manually precreated with using VMware full clones or tools with space-efficient VM provisioning capabilities, for example, the NetApp VSC Provisioning and Cloning plug-in**, and can be automatically **imported** into VMware View.

The manual desktop pool supports two types of user assignment:

- **Dedicated assignment:** Users are assigned a desktop that can retain all of their documents, applications, and settings between sessions. The desktop is statically assigned the first time the user connects and is then used for all subsequent sessions.
 - **Floating assignment:** Users are not assigned to particular desktops and could get connected to a different desktop from the pool each time they connect. Also, there is no data persistence of profile or user data between sessions without using third party software or roaming profiles.
- **Automated desktop pools:** This pool type provides the assignment of multiple users to multiple desktops, with only one active user on a desktop at a time. The creation and customization of these types of desktops are performed by VMware View and optionally with VMware View Composer by using either of these two options:
 - **Full clone:** Leveraging VMware vCenter virtual machine template to create VMware full clones.
 - **Linked clone:** Leveraging VMware View Composer feature in VMware View 4.5 to create VMware linked clones.

Both options in automated desktop pools support the two types of user assignment:

- **Dedicated assignment:** Users are assigned a desktop that can retain all of their documents, applications, and settings between sessions. The desktop is statically assigned the first time the user connects and is then used for all subsequent sessions.

- **Floating assignment:** Users are not assigned to particular desktops and could get connected to a different desktop from the pool each time they connect. Also, there is no persistence of environmental or user data between sessions.
- **Terminal server pool:** This is a pool of terminal server desktop sources served by one or more terminal servers. Discussion on the storage best practices for this type of desktop delivery model is outside the scope of this document.

Table 1) Manual vs. automated pool types.

Pool Type	Provisioning Method	Desktop Data Persistence	User Assignment
Manual Desktop Pool	NetApp VSC 2.0 Provisioning and Cloning Plug-in	Persistent/Nonpersistent	Dedicated/Floating
Automated Desktop Pool	VMware View Composer Full Clones	Persistent/Nonpersistent	Dedicated/Floating
	VMware View Composer Linked Clones	Persistent/Nonpersistent	Dedicated/Floating

For more details on VMware View desktop pools and user assignment, refer to the [VMware View Manager Administrator Guide](#).

5 NETAPP SOLUTION AND COMPONENTS

NetApp provides a scalable, unified storage and data management solution for VMware View. The unique benefits of the NetApp solution are:

- **Storage efficiency:** Significant cost savings with multiple levels of storage efficiency for all the VM data components.
- **Performance:** Enhanced user experience with transparent read and write I/O optimization that strongly complements NetApp's storage efficiency capabilities.
- **Operational agility:** Enhanced VMware View solution management with tight partner integration.
- **Data protection:** Enhanced protection of both the virtual desktop OS data and the user data, with very low overhead for both cost and operations.

5.1 SINGLE SCALABLE UNIFIED ARCHITECTURE

The NetApp unified storage architecture provides customers with an agile and scalable storage platform. NetApp's innovative storage solutions provide customers new alternatives and expanded possibilities over traditional storage vendors. All NetApp storage systems utilize the Data ONTAP operating system to provide SAN (FCoE, FC, iSCSI), NAS (CIFS, NFS), primary storage, and secondary storage within a single unified platform so that all virtual desktop data components can be hosted on the same storage array. A single process for activities such as installation, provisioning, mirroring, backup, and upgrading is used throughout the entire product line from the entry level to enterprise-class controllers. Having a single set of software and processes brings great simplicity to even the most complex enterprise data management challenges. Unifying storage and data management software and processes reduces the complexity of data ownership, enables companies to adapt to their changing business needs without interruption, and results in a dramatic reduction in total cost of ownership.

For large, scalable VMware View environments, the NetApp solution provides the following unique benefits:

- At least 50% savings in storage, power, and cooling requirements
- Most agile and operationally efficient storage solutions
- Best-in-class data protection and business continuance solutions to address any level of data availability demands

5.2 STORAGE EFFICIENCY

One of the critical barriers to VDI adoption is the increased cost of using shared storage to obtain a highly available enterprise quality infrastructure. Virtual desktop deployment creates a high level of data redundancy, especially for the VM OS data. Using traditional storage, this means you need storage equal to the sum of the storage required by each VM. For example, if each VM is 20GB in size and there are supposed to be 1000 VMs in the solution, it would require at least 20TB usable data on the shared storage.

Thin provisioning, data deduplication, and FlexClone[®] are the critical components of the NetApp solution and offer multiple levels of storage efficiency across the virtual desktop OS data, installed applications, and user data. This helps customers save on average 50% to 90% on the cost associated with shared storage (based on existing customer deployments and NetApp solutions lab validation). NetApp is the only storage vendor that offers block-level data deduplication for live virtual machines, without any negative tradeoffs.

THIN PROVISIONING

Thin provisioning is a way of logically presenting more storage to hosts than physically available. With thin provisioning, the storage administrator is able to utilize a pool of physical disks (known as an aggregate) and create logical volumes for different applications to use, while not preallocating space to those volumes. The space gets allocated only when the host needs it. The unused aggregate space is available for the existing thinly provisioned volumes to expand or for use in creation of new volumes. For more details on thin provisioning, review [NetApp TR-3563: NetApp Thin Provisioning](#).

Traditional Provisioning

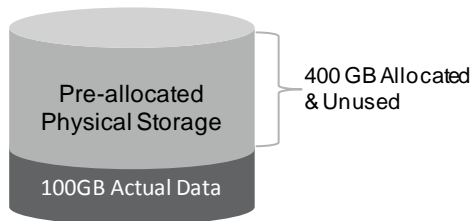

Thin Provisioning

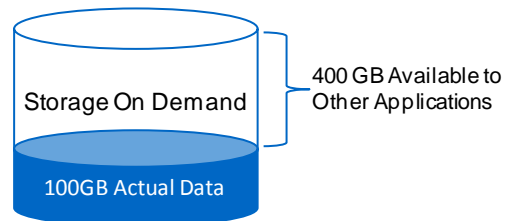

Figure 2) Traditional and thin provisioning.

Typical: 40% Utilization

NetApp: 70+% Utilization

50% less Storage*

50% less Power & Cooling

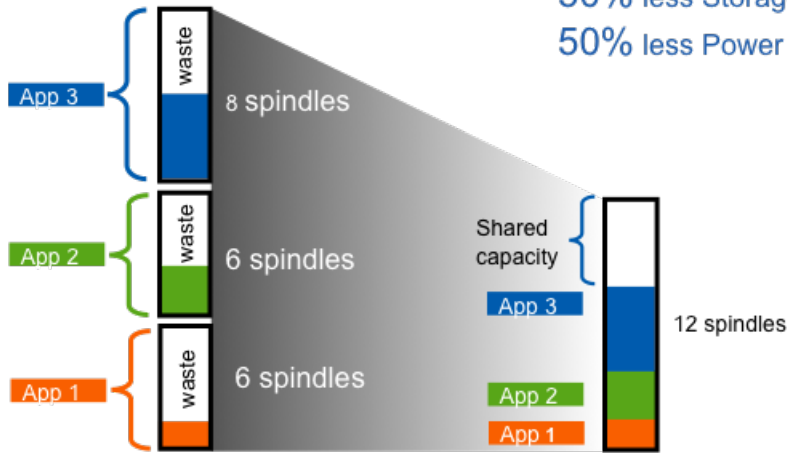

Standard Volume Manager

NetApp Thin Provisioning

Source: Oliver Wyman Study: "Making Green IT a Reality." November 2007.

*Thin Provisioning, clones, & multiprotocol all contribute to savings.

Figure 3) Increased disk utilization with NetApp thin provisioning.

NETAPP DEDUPLICATION

NetApp deduplication saves space on primary storage by removing redundant copies of blocks within a volume hosting hundreds of virtual desktops. This process is transparent to the application and user and can be enabled and disabled on the fly. In a VMware View environment, deduplication provides significant space savings, given that each VM is an identical copy of the OS, applications, and patches. The savings are also achieved for the user data hosted on CIFS home directories. For more information on NetApp deduplication, refer to [NetApp TR-3505: NetApp Deduplication for FAS, Deployment and Implementation Guide](#).

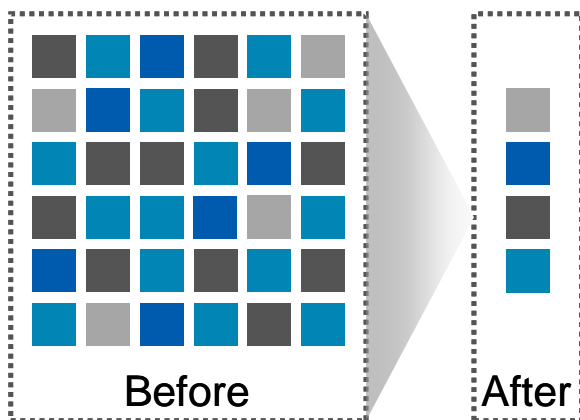

Figure 4) NetApp deduplication.

FLEXCLONE

NetApp FlexClone technology is hardware-assisted rapid creation of space-efficient, writable, point-in-time images of individual files, LUNs, or flexible volumes. The use of FlexClone technology in VMware View deployments provides high levels of scalability and significant cost, space, and time savings. Both file-level cloning and volume-level cloning are tightly integrated with the VMware vCenter Server using the NetApp Virtual Storage Console (VSC) Provisioning and Cloning vCenter plug-in. The VSC provides the flexibility to provision and redeploy thousands of VMs rapidly with

hundreds of VMs in each datastore. Note that from a scalability and manageability perspective, this allows for very few datastores to provision and manage as compared to other solutions, which might require one datastore per VM.

FlexClone adds a new level of agility and efficiency to storage operations. FlexClone volumes take only seconds to create and are nondisruptive to the parent FlexVol[®] volume or VM. FlexClone copies share the same physical data space as the source and occupy negligible space (metadata) on the storage system. FlexClone file-level or volume-level clones use space very efficiently, leveraging the Data ONTAP architecture to store only data that changes between the source and clone. In addition to all these benefits, file-level or volume-level FlexClone volumes have the same high performance as other FlexVol volumes or files hosted on the volumes. Also, FlexClone technology provides significant benefits with disaster recovery (DR) testing. DR testing with FlexClone is safe, risk free, and can be done during operational hours at any time. For more information on FlexClone technology concepts, see [NetApp TR-3347: FlexClone Volumes: A Thorough Introduction](#).

5.3 PERFORMANCE

Another critical barrier to VMware View adoption is performance issues associated with hosting thousands of VMs on shared storage, specifically performance associated with events that produce a large influx of simultaneous I/O such as login storms, boot storms, and antivirus operations. With physical desktops, this was not a problem as each machine had its own disks and I/O was contained within a single desktop. With VMware View using a shared storage infrastructure, significant performance issues might arise during these critical operations. This essentially means the solution would require a large number of additional spindles to meet the performance requirements, resulting in increased overall solution cost.

To solve this problem, the NetApp solution contains transparent storage cache sharing (TSCS). Transparent storage cache sharing is a core component of Data ONTAP and is extended with Flash Cache (or PAM). These solution components save customers money by:

- Requiring far less disks and cache
- Serving read data from cache freeing up disk I/O to perform writes
- Providing better throughput and system utilization
- Providing faster response times and a better overall end user experience

TRANSPARENT STORAGE CACHE SHARING

Transparent storage cache sharing (TSCS) allows customers to benefit from NetApp's storage efficiency and at the same time significantly increase I/O performance. TSCS is natively built into the Data ONTAP operating system and works by leveraging block-sharing technologies such as NetApp primary storage deduplication and file/volume FlexClone to reduce the amount of cache required and eliminate duplicate disk reads. Only one instance of any duplicate block is read into cache, thus requiring less cache than traditional storage solutions. Since VMware View implementations can see as great as 99% initial space savings (validated in the NetApp solutions lab) using NetApp space-efficient cloning technologies, this translates into higher cache deduplication and high cache hit rates. TSCS is especially effective in addressing the simultaneous system boot or "boot storm" of hundreds to thousands of virtual desktop systems that can overload a traditional legacy storage system.

FLASH CACHE AND PAM

NetApp Flash Cache and PAM are hardware devices that extend the native Data ONTAP TSCS capabilities. Flash Cache increases the amount of available cache which helps reduce virtual desktop storm activities. More details of Flash Cache will be discussed later in this document. For more details on NetApp Flash Cache technology, visit www.netapp.com/us/products/storage-systems/flash-cache/flash-cache-tech-specs.html

Note: For the remainder of this document, the use of Flash Cache will represent both the Flash Cache and PAM modules.

FLEXIBLE VOLUMES AND AGGREGATES

Flexible volumes (also known as FlexVol volumes) and aggregates provide pools of storage. This storage virtualization allows the performance and capacity to be shared by all desktops in the volume or aggregate. Much like the way that VMware virtualizes computing resources, NetApp virtualizes the storage resources.

5.4 OPERATIONAL AGILITY

Implementation and management complexities associated with deploying a VMware View solution are another potential barrier to VDI adoption. The NetApp management solution is operationally agile and provides tight integration with VMware vCenter for rapidly provisioning, managing, configuring, and backing up a VMware View implementation. This section will discuss the components of the NetApp plug-in framework for vSphere, the Virtual Storage Console.

VIRTUAL STORAGE CONSOLE 2.0 (VSC)

The NetApp Virtual Storage Console 2.0 (VSC) for VMware vSphere enables one to manage ESX and ESXi servers connected to NetApp storage systems. VSC is a plug-in to the VMware vCenter that is available to all vSphere clients that connect to the vCenter server. The core function of the VSC allows VMware administrators the ability to configure best practice HBA/CNA timeout values, MPIO settings, and NFS settings; monitor storage capacity and deduplication savings; and collect data for troubleshooting.

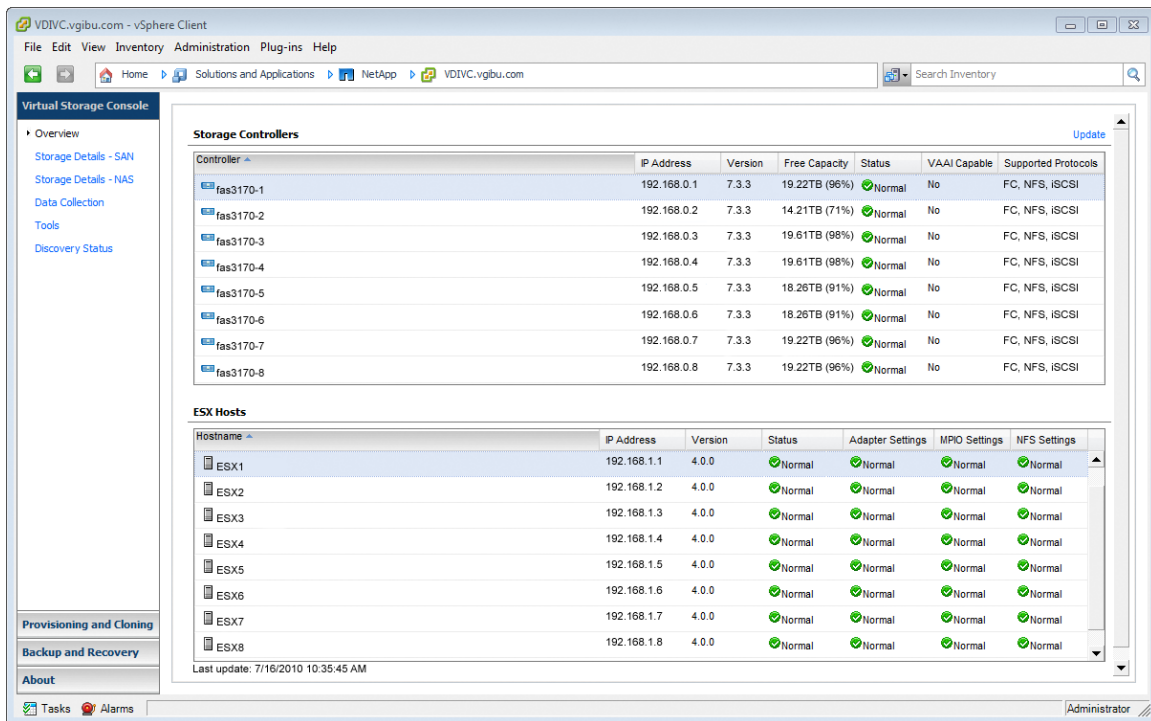

Figure 5) NetApp VSC plug-in.

PROVISIONING AND CLONING PLUG-IN (V3.1)

The NetApp VSC Provisioning and Cloning plug-in v3.1 provides customers with the ability to rapidly provision, manage, import, and redeploy thousands of VMs. This plug-in leverages file and volume FlexClone technologies, discussed earlier, to create hardware-assisted clones. It is tightly integrated into VMware vCenter as a module of the NetApp VSC 2.0 and can automatically import VMs directly into VMware View 4.5. Once provisioned, the Provisioning and Cloning plug-in can redeploy VMs after patches have been applied to the baseline image. The plug-in also allows VMware administrators the ability to initiate, view, and control deduplication; configure and provision new datastores for NFS, iSCSI, and Fibre Channel and FCoE protocols; resize existing NFS datastores; and destroy datastores. With the provisioning and cloning capabilities of the VSC 2.0, customers are able to achieve the desired storage efficiency, rapid provisioning, and patch management associated with both dedicated and floating user assignment and persistent and nonpersistent desktops and still be able to achieve performance acceleration with TSCS.

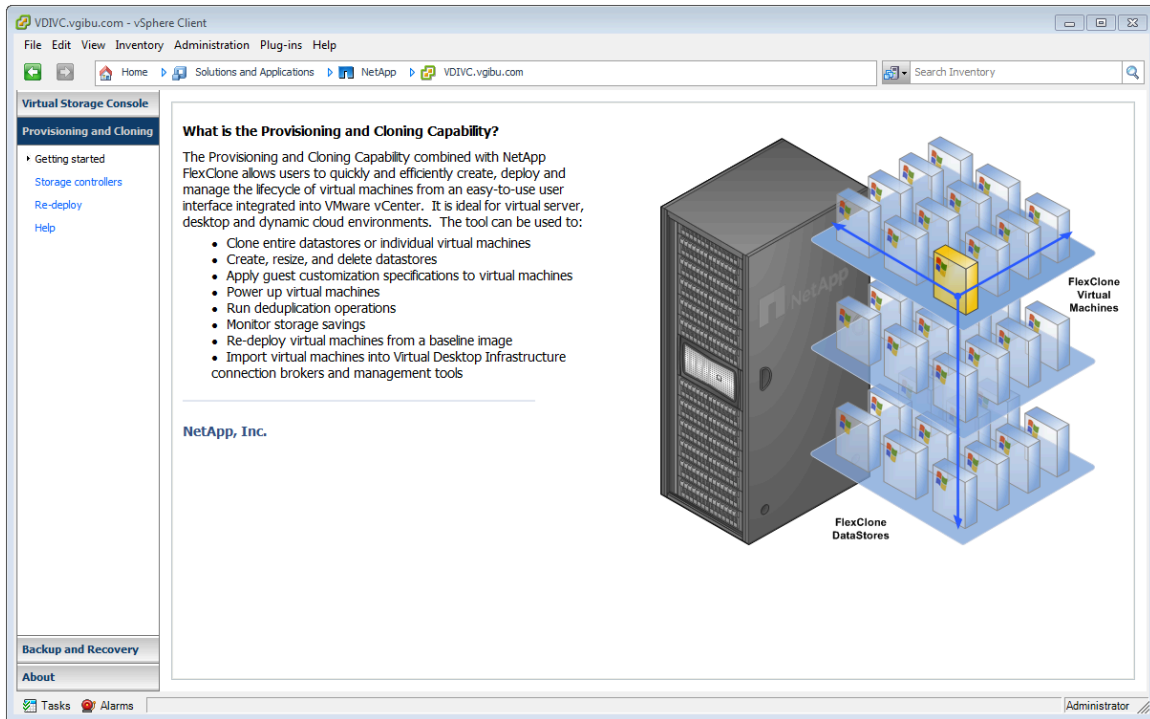

Figure 6) NetApp Provisioning and Cloning plug-in in VMware vCenter.

BACKUP AND RECOVERY PLUG-IN

The NetApp VSC Backup and Recovery plug-in (formerly SMVI) is a unique, scalable data protection plug-in for VMware vSphere and the VMware View solution. The Backup and Recovery plug-in is now distributed as a part of the Virtual Storage Console 2.0. It integrates VMware snapshot functionality with NetApp Snapshot™ to protect VMware View environments. More information is available in the data protection section of this document.

SANSCREEN VM INSIGHT

Also available as a VMware vCenter plug-in, NetApp SANscreen® VM Insight also provides cross-domain visibility from the VM to the shared storage, allowing both storage and server administration teams to more easily manage their VMware View storage and server infrastructure. VM Insight provides service-level information for virtual servers, physical servers, and storage devices, as well as VM volume, allocated capacity, and datastore information from VMware vCenter. Based on this visibility, VM Insight shows the actual service paths and server performance information to allow end-to-end monitoring. The enterprise-class data warehouse provides IT the ability to access, query, and analyze VM data; and, when deployed with SANscreen Capacity Manager, it enables capacity planning and chargeback for VM environments. For further details on SANscreen VM Insight, visit the following solutions page: www.netapp.com/us/products/management-software/sanscreen/sanscreen-vm-insight.html.

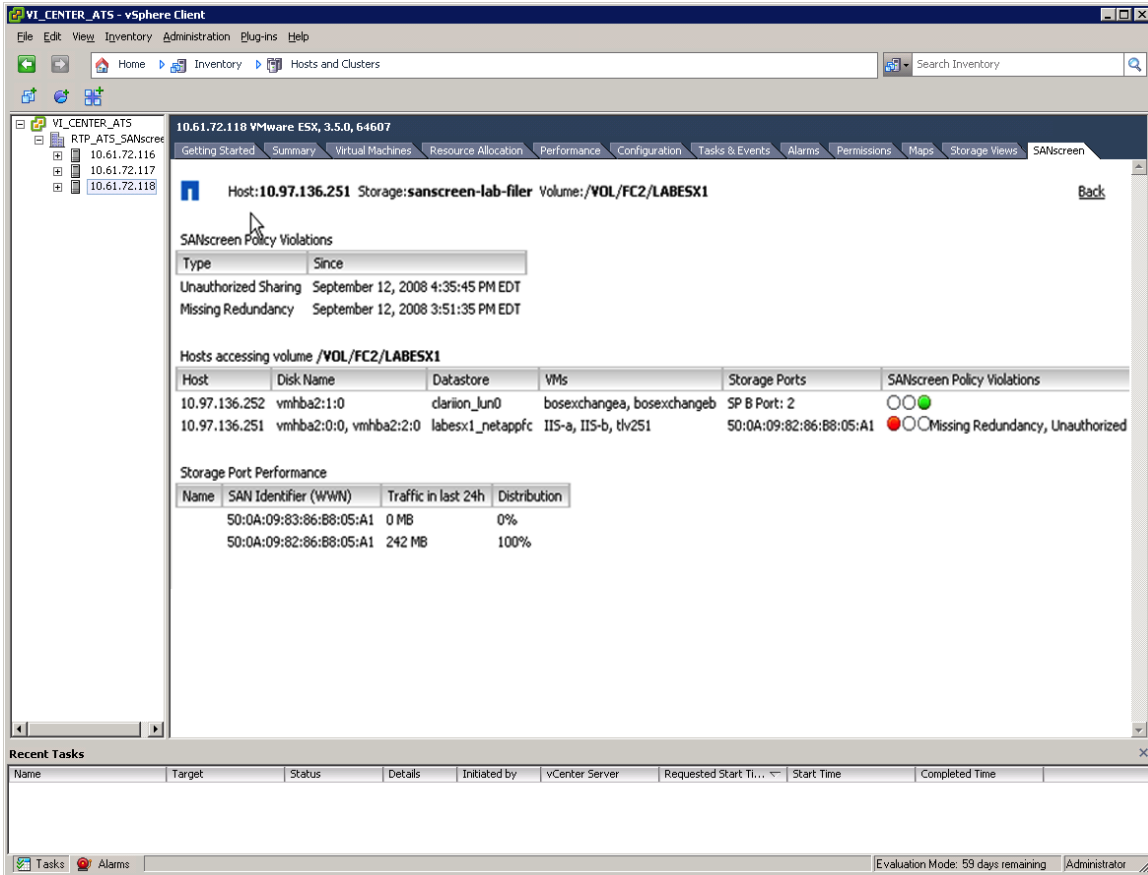

Figure 7) NetApp SANSscreen VM Insight plug-in in VMware vCenter.

OPERATIONS MANAGER

NetApp Operations Manager provides a comprehensive monitoring and management solution for the VMware View storage infrastructure. It provides comprehensive reports of utilization and trends for capacity planning and space usage. It also monitors system performance, storage capacity, and health to resolve potential problems. For further details on Operations Manager, visit the following solutions page: www.netapp.com/us/products/management-software/operations-manager.html.

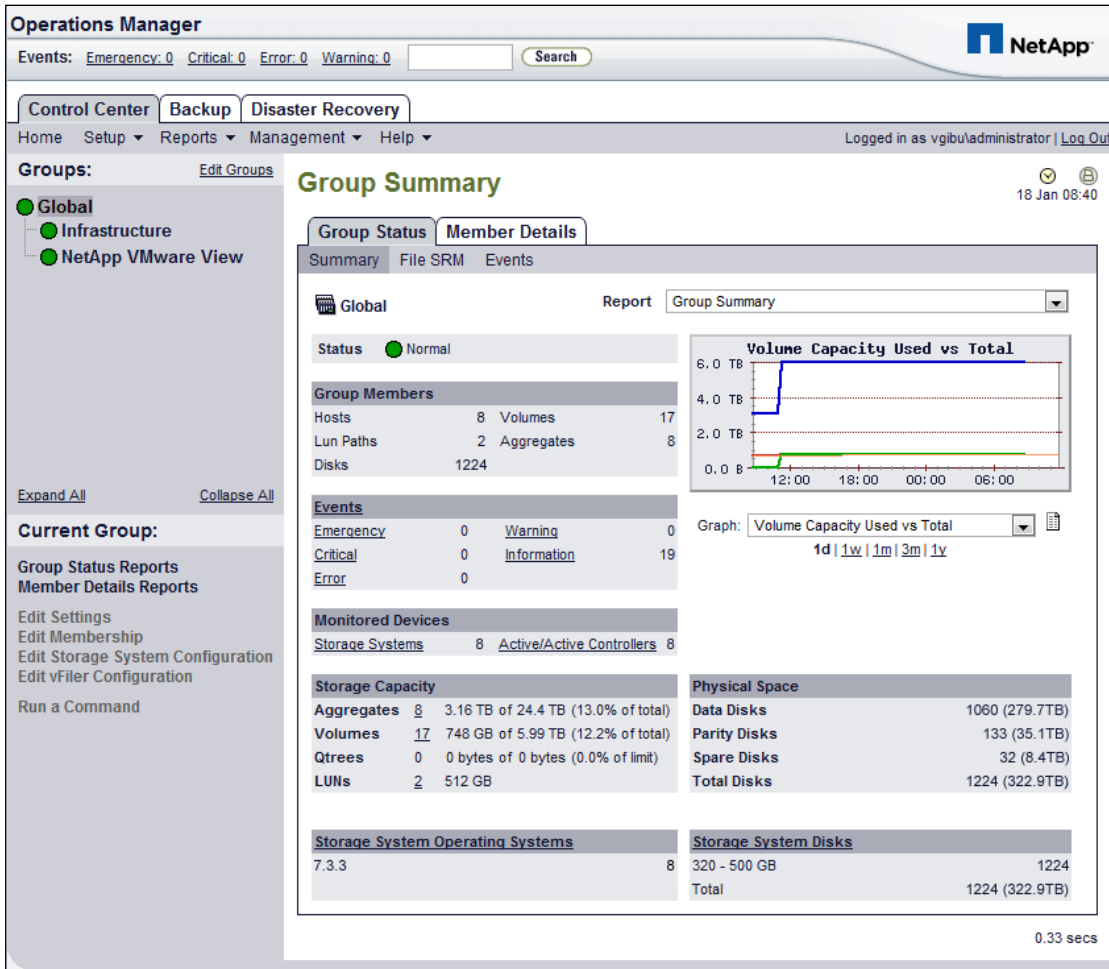

Figure 8) NetApp Operations Manager.

5.5 DATA PROTECTION

The availability of thousands of virtual desktops is dependent on the availability of the shared storage on which the virtual desktops are hosted. Thus, using the proper RAID technology is very critical. Also, being able to protect the virtual desktop images and/or user data is very important. RAID-DP®, the VSC 2.0's Backup and Recovery plug-in, NetApp SnapMirror®, and NetApp Snapshot copies are critical components of the NetApp solution that help address storage availability.

RAID-DP

With any VMware View deployment, data protection is critical, because any RAID failure could result in hundreds to thousands of end users being disconnected from their desktops, resulting in lost productivity. RAID-DP provides performance that is comparable to that of RAID 10, yet requires fewer disks to achieve equivalent protection. RAID-DP provides protection against double disk failure as compared to RAID 5, which can only protect against one disk failure per RAID group. For more information on RAID-DP, see [NetApp TR-3298: RAID-DP: NetApp Implementation of RAID Double Parity for Data Protection](#).

BACKUP AND RECOVERY PLUG-IN

The NetApp Backup and Recovery plug-in for VSC 2.0 is a unique, scalable, integrated data protection solution for protecting VMware View environments. The Backup and Recovery plug-in allows customers the ability to leverage VMware snapshot functionality with NetApp array-based block-level Snapshot copies to provide consistent backups for the virtual desktops. The Backup and Recovery plug-in is integrated with NetApp SnapMirror replication

technology, which preserves the deduplicated storage savings from the source to the destination storage array. Deduplication is then not required to be rerun on the destination storage array. Additionally, when a VMware View environment is replicated with SnapMirror, the replicated data can be quickly brought online to provide production access in the event of a site or data center outage. Also, SnapMirror is fully integrated with VMware Site Recovery Manager (SRM) and NetApp FlexClone technology to instantly create zero-cost writable copies of the replicated virtual desktops at the remote site that can be used for DR testing or for test and development work. For more information on SnapMirror, see [NetApp TR-3446: SnapMirror Best Practices Guide](#). For more information on VMware SRM integration, see [NetApp TR-3671: VMware Site Recovery Manager in a NetApp Environment](#). For more detailed information on the Backup and Recovery plug-in, see [NetApp TR-3737: SMVI Best Practices](#).

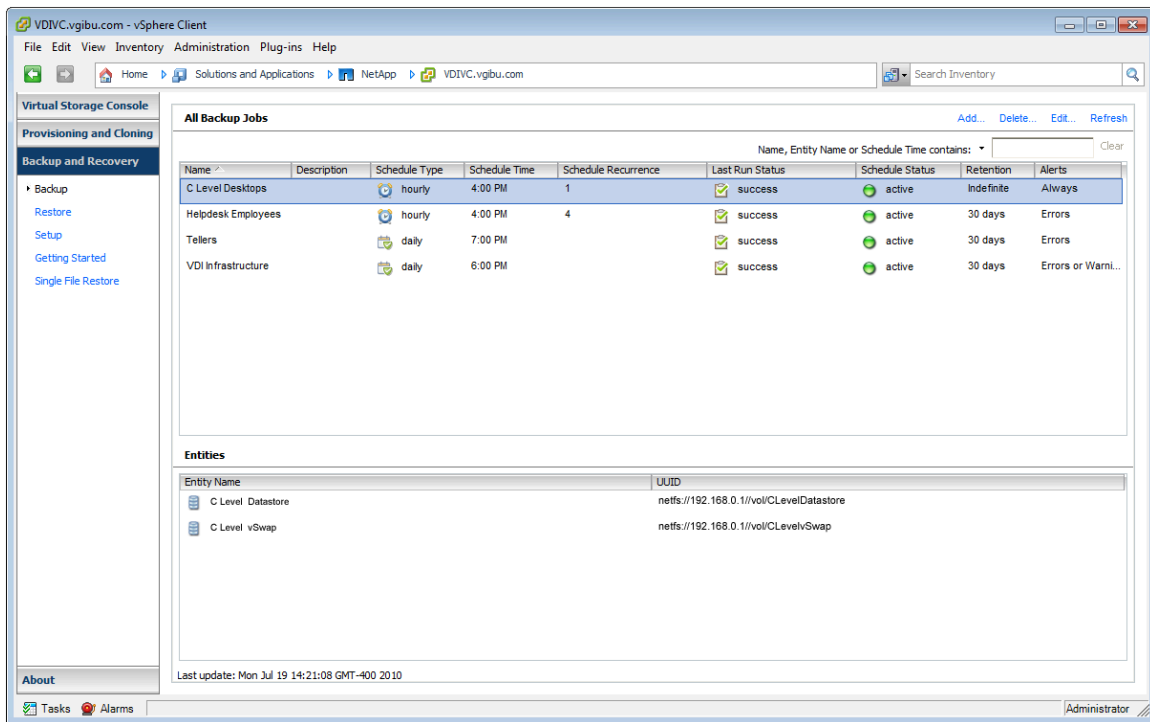

Figure 9) NetApp Backup and Recovery plug-in.

6 NETAPP AND VMWARE VIEW DESKTOP POOLS

There are two primary virtual desktop pool types available in VMware View 4.5:

- Manual desktop pool
- Automated desktop pool

Both the **manual desktop pool** and **automated desktop pool** models offer the ability to be randomly or statically assigned (dedicated and floating). Automated desktop pool offers two options in which virtual desktops can be provisioned: using VMware full clones and VMware View Composer linked clones.

Considering the flexibility in this architecture, there are a total of six ways in which virtual desktops can be provisioned and managed with VMware View:

- Manual desktop pool with dedicated assignment
- Manual desktop pool with floating assignment
- Automated desktop pool, leveraging VMware full clones with dedicated assignment
- Automated desktop pool, leveraging VMware full clones with floating assignment
- Automated desktop pool, leveraging VMware linked clones with dedicated assignment
- Automated desktop pool, leveraging VMware linked clones with floating assignment

Most businesses have a mix of worker types (for example, finance, HR, engineering, help desk, call centers, teleworkers, data entry operators, and so on), and each use case might require one or more of these six ways in which the virtual desktops can be provisioned and managed. Based on the requirements and mix of user profiles, companies might choose to implement one or more of these pools. For example, a company requirement might dictate a need for the following mix of desktop types:

- 10% individual desktops (for example, kiosks, part-time workers)
- 40% manual desktop pool with dedicated assignment (for example, management staff, human resources, analysts, R&D)
- 20% automated desktop pool, utilizing VMware full clones with dedicated assignment (for example, software developers)
- 30% automated desktop pool, utilizing VMware linked clones with floating assignment (for example, help desk representatives)

Considering this to be a real-world scenario, the desktop mix might vary over time as more and more desktops are virtualized. However, the ultimate objective is to make sure that the complete end-to-end solution that is implemented can be easily managed, be cost effective, and provide a best-in-class end-user experience.

The NetApp value proposition of storage efficiency, performance, operational agility, and data protection strongly complements all these six ways in which virtual desktops can be deployed and managed, as shown in Table 2.

Table 2) NetApp value proposition.

VMware View			NetApp and VMware Solution				
Desktop Pool Type	Provisioning Method	User Assignment	Storage Efficiency		Performance	Operational Agility	Data Protection
			OS Data	User Data			
Manual Pool	NetApp VSC Provisioning and Cloning Capability	Dedicated	✓	✓	✓	✓	✓
		Floating	✓	✓	✓	✓	✓
Automated Pool	VMware View Composer Full Clones	Dedicated	✓	✓	✓	✓	✓
		Floating	✓	✓	✓	✓	✓
	VMware View Composer (Linked Clones)	Dedicated	✓	✓	✓	✓	✓
		Floating	✓	✓	✓	✓	✓

Let us go into the details of each of the VMware View desktop pool types and user assignment types and validate how the NetApp solution strongly complements each one of them to achieve your ultimate goals and objectives.

6.1 MANUAL DESKTOP POOL

If you are planning to implement manual desktop pool as part of the solution, you might choose to implement either the **dedicated** or **floating user assignment**. For both of these types of user assignments, the desired storage efficiency for the VM OS data (50% to 90%) and user data (up to 50%) can be achieved using the NetApp thin provisioning, deduplication, and FlexClone components of the solution. Note that the NetApp best practice is to store the user data and profile in a CIFS share on a NetApp NAS volume and served using [Microsoft® roaming profiles](#) and/or [folder redirection](#) or using a third-party profile management solution. This allows better management and protection of the important user data. NetApp write I/O optimization and transparent storage cache sharing help achieve the desired end-user experience. Space-efficient VMs can be rapidly created or redeployed and imported into VMware View using the VSC Provisioning and Cloning plug-in. Effective solution monitoring, management, and data protection can be achieved using VM Insight, Operations Manager, VSC's Backup and Restore plug-in, SnapVault®, SnapMirror, and RAID-DP.

Table 3) Manual desktop pool.

VMware View			NetApp and VMware Solution				
Desktop Pool Type	Provisioning Method	User Assignment	Storage Efficiency		Performance	Operational Agility	Data Protection
			OS Data	User Data			
Manual Pool	NetApp VSC Provisioning and Cloning Capability	Dedicated	✓	✓	✓	✓	✓
		Floating	✓	✓	✓	✓	✓
Automated Pool	VMware View Composer Full Clones	Dedicated	✓	✓	✓	✓	✓
		Floating	✓	✓	✓	✓	✓
	VMware View Composer (Linked Clones)	Dedicated	✓	✓	✓	✓	✓
		Floating	✓	✓	✓	✓	✓

6.2 AUTOMATED DESKTOP POOL

If you are planning to implement automated desktop pools as part of the solution, you might choose to implement a VMware full clone solution, a VMware linked clone solution, or a mix of the two.

VMWARE FULL CLONE

This solution supports use of both **dedicated** and **floating** user assignment. With both of these types of user assignments, the desired storage efficiency for the VM OS data (50% to 90%) and user data (up to 50%) can be achieved using NetApp thin provisioning and deduplication components of the solution. NetApp best practice is to store the user data and profile in a CIFS share on a NetApp NAS volume and served using [Microsoft roaming profiles](#) and/or [folder redirection](#) or using a third-party profile management solution. This allows better management and protection of the important user data. NetApp write I/O optimization and transparent storage cache sharing help achieve the desired end-user experience. Effective solution monitoring, management, and data protection can be achieved using VM Insight, Operations Manager, VSC’s Backup and Recovery plug-in, SnapVault, SnapMirror, and RAID-DP.

Table 4) VMware full clone.

VMware View			NetApp and VMware Solution				
Pool Type	Provisioning Method	User Assignment	Storage Efficiency		Performance	Operational Agility	Data Protection
			OS Data	User Data			
Manual Pool	NetApp VSC Provisioning and Cloning Capability	Dedicated Floating	Thin Provisioning FlexClone Deduplication	CIFS Thin Provisioning Deduplication	Write I/O Optimization TSCS Flash Cache	VSC Provisioning and Cloning VM Insight Operations Manager VSC Backup and Recovery	RAID-DP VSC Backup and Recovery SnapMirror SnapVault

VMWARE LINKED CLONE

The VMware linked clone solution also supports both the persistent and nonpersistent access modes.

- For **persistent** access mode, the desired storage efficiency (50% to 90%) for the VM **“OS data disk”** can be achieved using VMware linked clones and NetApp thin provisioning components of the solution. The storage efficiency for the **“user data disk”** (up to 50%) can be achieved using NetApp deduplication and thin provisioning. Alternatively, depending on your data management and protection requirements for the important user data, you might choose to follow the same process of storing the user data and profile in a CIFS share on a NetApp NAS volume and served using [Microsoft roaming profiles](#) and/or [folder redirection](#).
- For **nonpersistent** access mode, the desired storage efficiency (50% to 90%) for the VM **“OS data disk”** can be achieved using VMware linked clones and NetApp thin provisioning components of the solution. The storage efficiency (up to 50%) for the user data can be achieved using NetApp deduplication and thin provisioning. Note that the NetApp best practice is to store the user data and profile in a CIFS share on a NetApp NAS volume and served using [Microsoft roaming profiles](#) and/or [folder redirection](#). This allows better management and protection of the important user data.

For both persistent and nonpersistent access modes, NetApp write I/O optimization and transparent storage cache sharing help enhance the end-user experience. Effective solution monitoring, management, and data protection can be achieved using VM Insight, Operations Manager, VSC Backup and Recovery, SnapVault, SnapMirror, and RAID-DP.

Table 5) VMware View Composer (linked clones).

VMware View			NetApp and VMware Solution				
Pool Type	Provisioning Method	User Assignment	Storage Efficiency		Performance	Operational Agility	Data Protection
			OS Data	User Data			
Automated Desktop Pool	VMware View Composer (Full Clones)	Dedicated Floating	Thin Provisioning Deduplication	CIFS Thin Provisioning Deduplication	Write I/O Optimization TSCS Flash Cache	VM Insight Operations Manager VSC Backup and Recovery	RAID-DP VSC Backup and Recovery SnapVault SnapMirror

To summarize, a NetApp solution strongly complements all the desktop delivery models and user access modes in VMware View to provide a highly cost-effective, high-performing, operationally agile, and integrated VMware View solution.

7 ACCELERATING VMWARE VIEW WITH READ AND WRITE I/O OPTIMIZATION

7.1 CONCEPTS

Virtual desktops can be both read and write intensive at different times during the lifecycle of the desktop, depending on the user activity and the desktop maintenance cycle. The performance-intensive activities are experienced by most large-scale deployments and are referred to as storm activities such as:

- Boot storms
- Login storms
- Virus scan and/or definition update storms

A boot storm is an event when some or all virtual desktops boot simultaneously, creating a large spike in I/O. This can happen as a result of rolling out mass OS updates and having to reboot, desktop redeploy operations, new application installation, maintenance windows, server failures, or any number of practical issues or interruptions. Daily login storms and virus scan storms also create similar I/O spikes. In the physical world this was never a problem as each machine had a single disk, and boot, login, and virus scanning did not affect other users. With virtual desktops using a shared infrastructure, these peaks in I/O affect the entire desktop environment. The environment needs to be

able to handle both the read- and write-intensive scenarios in the desktop lifecycle. The typical methods for addressing these peaks are:

- Increase cache for both ESX servers and storage devices
- Increase the spindle count
- Increase the number of storage arrays

The NetApp and VMware View solution addresses these challenges in a unique way, with *no* negative tradeoffs to the customer environment. The NetApp transparent storage cache sharing in Data ONTAP, Flash Cache, write I/O optimization by coalescing multiple client write I/O operations as a single disk I/O, FlexClone, and deduplication are key components of the NetApp and VMware View solution. NetApp **transparent storage cache sharing** helps customers reduce the physical storage requirement, allowing customers to size their virtual desktop infrastructures for normal operations and not for the peaks.

Note: NetApp transparent storage cache sharing eliminates the requirement for a large number of spindles to handle the bursty read-intensive operations, while NetApp FlexClone and deduplication can further reduce the number of spindles required to store data, thus allowing customers to reduce capex.

7.2 NETAPP WRITE OPTIMIZATION

Virtual desktop I/O patterns are often very random in nature. Random writes are the most expensive operation for almost all RAID types because each write operation requires more than one disk operation. The ratio of VDI client operation to disk operation also depends on the RAID type for the back-end storage array. In a RAID 5 configuration on a traditional storage array, each client write operation requires up to four disk operations. Large write cache might help, but traditional storage arrays still require at least two disk operations. (Some coalescing of requests will happen if you have a big enough write cache. Also, there is a chance that one of the reads might come from read cache.) In a RAID 10 configuration, each client write operation requires two disk operations. The cost of RAID 10 is very high compared to RAID 5. However, RAID 5 offers lower resiliency (protection against single disk failure). Imagine dual disk failure in the middle of the day, making hundreds to thousands of users unproductive.

With NetApp, write operations have been optimized for RAID-DP by the core operating system Data ONTAP and WAFL® since their invention. NetApp arrays coalesce multiple client write operations and send them to disk as a single IOP. Therefore, the ratio of client operations to disk operations is always less than 1, as compared to traditional storage arrays with RAID 5 or RAID 10 which require at least 2x disk operations per client operation. Also, RAID-DP provides the desired resiliency (protection against dual disk failure) and performance, comparable to RAID 10 but at the cost of RAID 5.

7.3 BENEFITS OF TRANSPARENT STORAGE CACHE SHARING

The following are some of the key benefits of transparent storage cache sharing:

- **Increased performance:** With transparent storage cache sharing, in combination with FlexClone and deduplication, latencies decrease significantly by a factor of 10x versus serving data from the fastest spinning disks available, giving submillisecond data access. Decreasing the latency results in higher throughput and lower disk utilization, which directly translate into fewer disk reads.
- **Lowering TCO:** Requiring fewer disks and getting better performance allow customers to increase the number of virtual machines on a given storage platform, resulting in a lower total cost of ownership.
- **Green benefits:** Power and cooling costs are reduced as the overall energy needed to run and cool the Flash Cache module is significantly less than even a single shelf of Fibre Channel disks. A standard DS14mk4 disk shelf of 300GB 15K RPM disks can consume as much as 340 watts (W)/hr and generate heat up to 1394BTU/hr. In contrast, the Flash Cache module consumes only a mere 18W/hr and generates 90BTU/hr. By not deploying a single shelf, the power savings alone can be as much as 3000kWh/year per shelf. In addition to the environmental benefits of heating and cooling, each shelf not used saves 3U of rack space. For a real-world deployment, a NetApp solution (with Flash Cache as a key component) would typically replace several such storage shelves; therefore, the savings could be considerably higher than comparing to one disk shelf.

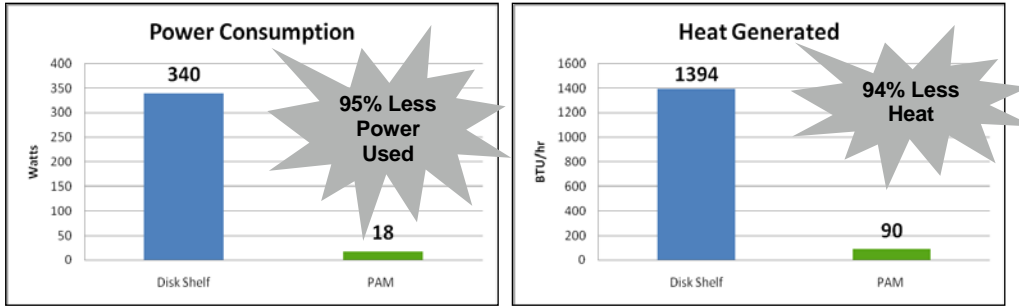
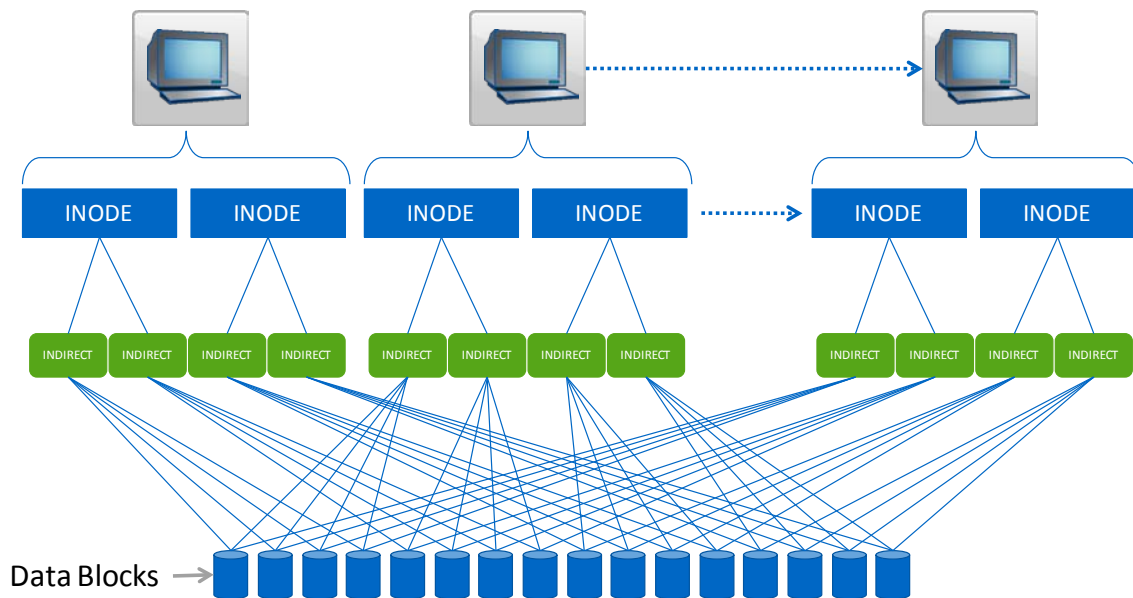

Figure 10) Power and heat savings for Flash Cache compared to one FC 15K disk shelf.

7.4 DEDUPLICATION AND NONDUPLICATION TECHNOLOGIES

Using NetApp deduplication and file FlexClone not only can reduce the overall storage footprint of VMware View desktops but also can improve performance by leveraging transparent storage cache sharing. Data that is deduplicated or nonduplicated, in the case of file FlexClone data, on disk will only exist in storage array cache once per volume. All subsequent reads from any of the VM disks (VMDKs) of a block that is already in cache will be read from cache and not from disk, therefore improving performance by 10x. Any nondeduplicated data that is not in cache must be read from disk. Data that is deduplicated but does not have as many block references as a heavily deduped VMDK will appear in cache only once but based on the frequency of access might be evicted earlier than data that has many references or is heavily used.



Deduplication within VMware Environments

VMware View deployments can reduce storage footprint by up to 99%.
 This diagram demonstrates the initial deployment where all blocks are duplicate blocks.

Figure 11) NetApp deduplication in VMware environments.

DEDUPLICATION GUIDELINES

- Deduplication is configured and operates on the flexible volumes only.
- Data can be deduplicated up to 255:1 without consuming additional space.
- Each storage platform has different deduplication limits.
- Each volume has dense and nondense size limits.

- Deduplication is configured using the command line.
- Requires Data ONTAP 7.2.5.1, 7.3P1, or later.
- Both a_sis and NearStore® must be licensed for deduplication to work.
- Run deduplication prior to creating Snapshot copies or running SnapMirror or SnapVault updates.

For more detailed information on deduplication, refer to [NetApp TR-3505: NetApp Deduplication for FAS, Deployment and Implementation Guide](#).

7.5 CACHING MODULES

THE PAM DEVICE

The PAM device is a PCI Express card that can be installed in FAS3X00, V3X00, FAS6000, and V6000 series platforms running Data ONTAP 7.3 or higher. Each module contains 16GB of DRAM. The VMware View solution can be composed of one (16GB) to 10 (160GB) Flash Cache modules per FAS or V-Series storage cluster depending on the customer requirements. Details on the number of modules per platform can be found at www.netapp.com/us/products/storage-systems/performance-acceleration-module/performance-acceleration-tech-specs.html.

FLASH CACHE

Flash Cache is a PCI Express card that can be installed in FAS3070, V3070, FAS3100, V3100, FAS6000, and V6000 series platforms running Data ONTAP 7.3.2 or higher. Each module contains either 256GB or 512GB of SLC NAND Flash. The VMware View solution can be composed of two (512GB) to eight (4TB) Flash Cache devices per FAS or V-Series storage cluster depending on the customer requirements. Details on the number of modules per platform can be found at www.netapp.com/us/products/storage-systems/performance-acceleration-module/performance-acceleration-tech-specs.html.

Note: Future references to Flash Cache in this document include both Flash Cache and PAM devices as functionally they are similar.

7.6 TRADITIONAL AND TRANSPARENT STORAGE CACHE SHARING

Transparent storage cache sharing is performed natively within Data ONTAP and can be extended with the use of Flash Cache. Flash Cache is the hardware component; the software component is called FlexScale™. This section will describe these components and the NetApp best practices to use them in a VMware View environment.

TRADITIONAL LEGACY STORAGE ARRAYS

With traditional legacy storage arrays, there is no data or cache deduplication and thus for best performance the amount of cache needed should be equal to or greater than the working set size. This leads to requiring either large amounts of cache or more spindles to satisfy peak workloads such as boot, login, or virus storms.

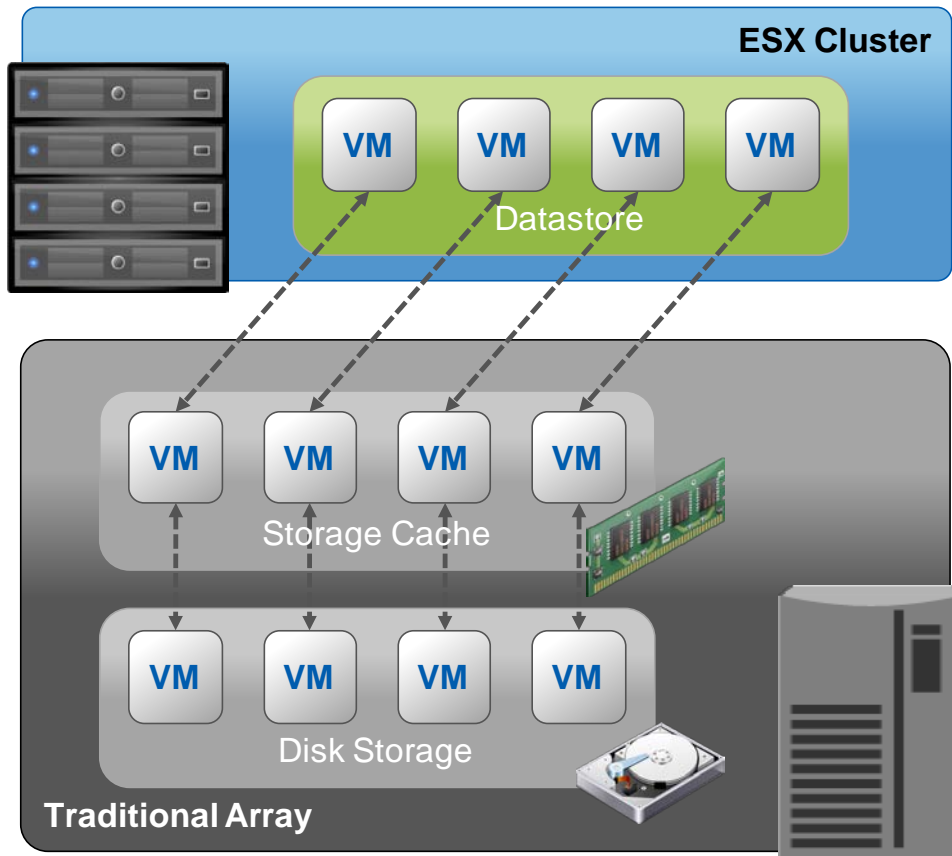

Figure 12) Traditional legacy storage array caching.

TRANSPARENT STORAGE CACHE SHARING IN DATA ONTAP

Data ONTAP will only store a single block on disk and in cache for up to 255 physical blocks per volume, thus requiring fewer spindles and less cache than legacy storage arrays. Data ONTAP transparent storage cache sharing is available in all versions of Data ONTAP 7.3.1 or higher. This means that transparent storage cache sharing can be used in every FAS, V-Series, and IBM N Series that supports Data ONTAP 7.3.1 and block-sharing technologies (for example, deduplication and FlexClone volumes).

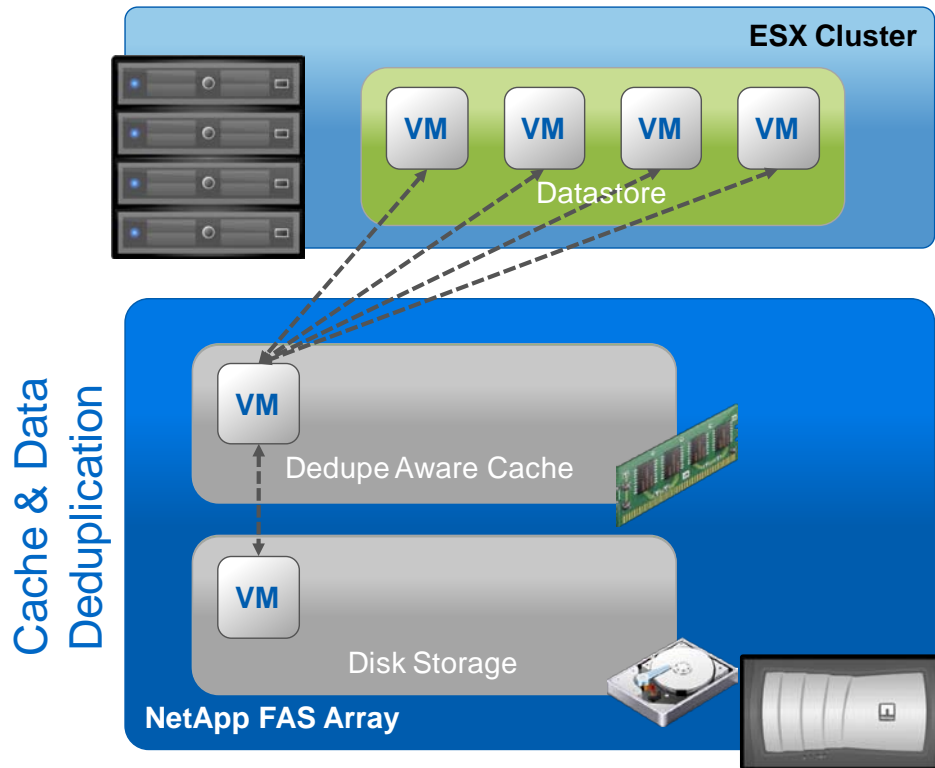

Figure 13) Cache and data deduplication with NetApp transparent storage cache sharing.

HOW DATA ONTAP TRANSPARENT STORAGE CACHE SHARING FUNCTIONS

When a data block is requested, Data ONTAP reads the block into main memory (also known as WAFL buffer cache). If that data block is a deduplicated block, in that it has multiple files referencing the same physical block, each subsequent read of that same physical block will come from cache as long as it has not been evicted from cache. Heavily referenced blocks that are frequently read will reside in cache longer than blocks that have fewer references or less frequent access. The effects this has are that since main memory can be accessed much more quickly than disk, latency is decreased, disk utilization is decreased, and network throughput is increased, thus improving overall performance and end-user experience.

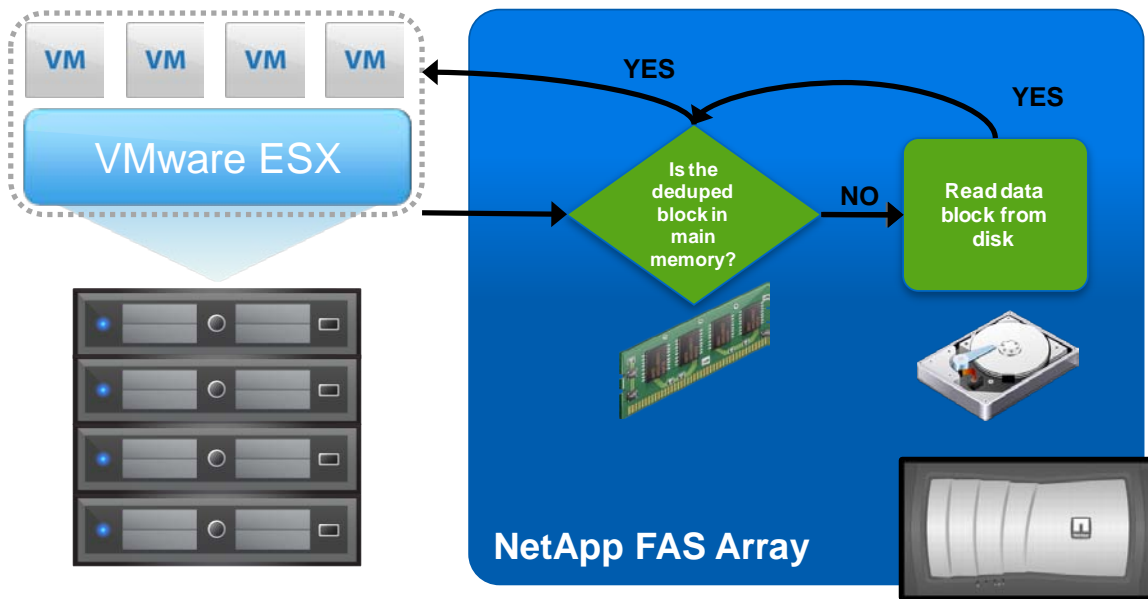

Figure 14) Transparent storage cache sharing with data deduplication.

HOW DATA ONTAP TRANSPARENT STORAGE CACHE SHARING FUNCTIONS WITH FLASH CACHE

Transparent storage cache sharing can be extended with the use of Flash Cache. As long as that block has not been evicted from both caches, all subsequent reads will be performed from main memory or Flash Cache, thus improving performance by not having to go to disk. Again, the more heavily the data is deduplicated and more frequently accessed, the longer it will stay in cache. Transparent storage array caching combined with NetApp disk deduplication provides cost savings on many levels.

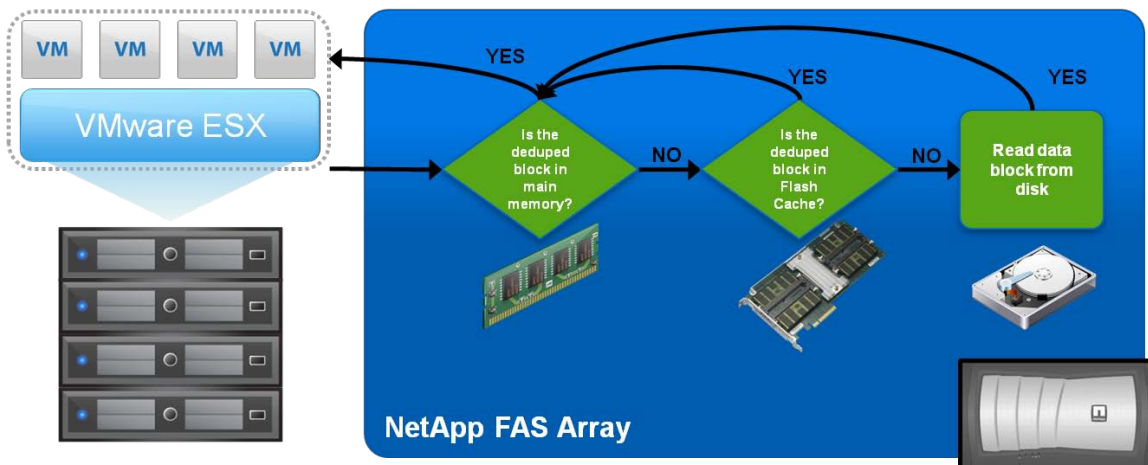

Figure 15) Transparent storage array caching with Flash Cache and deduplication.

The decision whether to use Flash Cache in addition to Data ONTAP transparent storage cache sharing is based on the amount of deduplicated data and the percentage of reads within the environment. As users of the VMware View environment create more data, the amount of deduplicated data will change, thus affecting the cache hit rate. Thus, more cache might be needed if the data becomes more unique (even after running regular deduplication operation on the new data).

NetApp recommends when possible to always use Data ONTAP 7.3.1 (Data ONTAP 7.3.2 when using Flash Cache) or later for VMware View environments. For environments with greater than 500 virtual desktops per NetApp storage

controller, NetApp recommends the use of both Data ONTAP caching and at least one Flash Cache device per storage controller.

HOW FLASH CACHE FUNCTIONS WITHOUT DEDUPLICATION (TRADITIONAL CACHING)

Flash Cache works by receiving data blocks that have been evicted from main memory. After being evicted from main memory, should the same block be requested a second time and that block has not been evicted from Flash Cache, that block is read from Flash Cache and placed into main memory. Every block, whether or not it contains the same data as another block, is read first from disk. This is how legacy storage arrays operate in that the first of all reads must come from disk, and subsequent reads depend on the size of the cache. This is the reason legacy vendors require large amounts of cache.

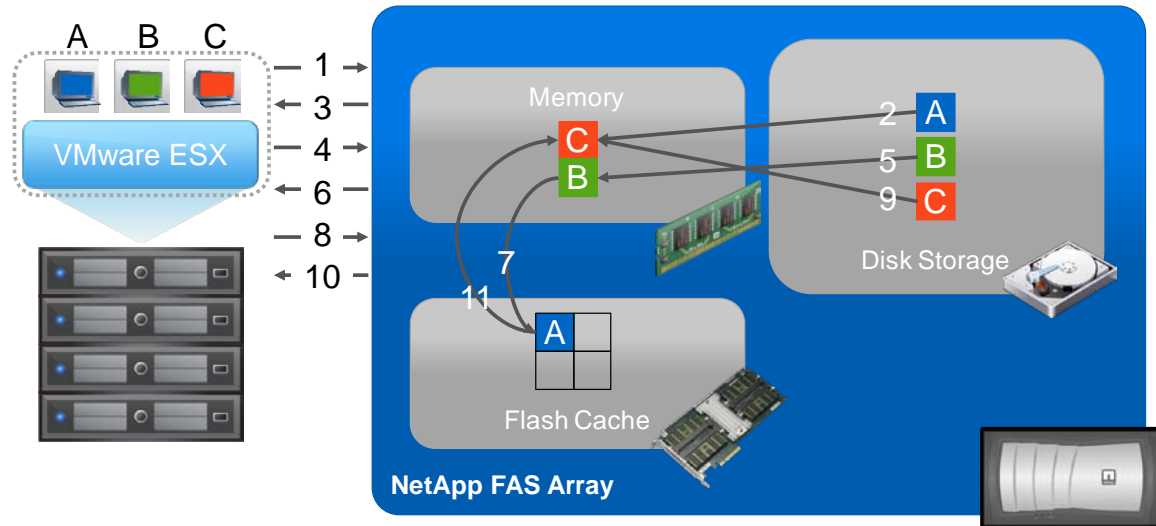

Figure 16) NetApp Flash Cache without deduplication.

1. Block A (blue) requested from client.
2. Block A (blue) read from disk to memory.
3. Block A (blue) returned to client.
4. Block B (green) requested from client.
5. Block B (green) read from disk to memory.
6. Block B (green) returned to client.
7. Block A (blue) evicted from memory to Flash Cache because memory is full.
8. Block C (orange) requested from client.
9. Block C (orange) read from disk to memory.
10. Block C (orange) returned to client.
11. Subsequent reads of block A (blue) or B (green) will result in the eviction of blocks C (orange) and reads from Flash Cache.

HOW FLASH CACHE FUNCTIONS WITH DEDUPLICATION (TRANSPARENT STORAGE ARRAY CACHING)

Flash Cache receives data blocks that have been evicted from main memory. After eviction from main memory, should a block be required for a second time, that block is read from Flash Cache, a cache hit, and placed into main memory. If the block being requested is a duplicate block that has been deduplicated (also known as a shared block), the block is read from Flash Cache to main memory. As long as that block is not evicted from cache, all subsequent reads will be performed from Flash Cache, thus improving performance by not having to go to disk. Transparent storage array cache combined with NetApp disk deduplication provides cost savings on many levels.

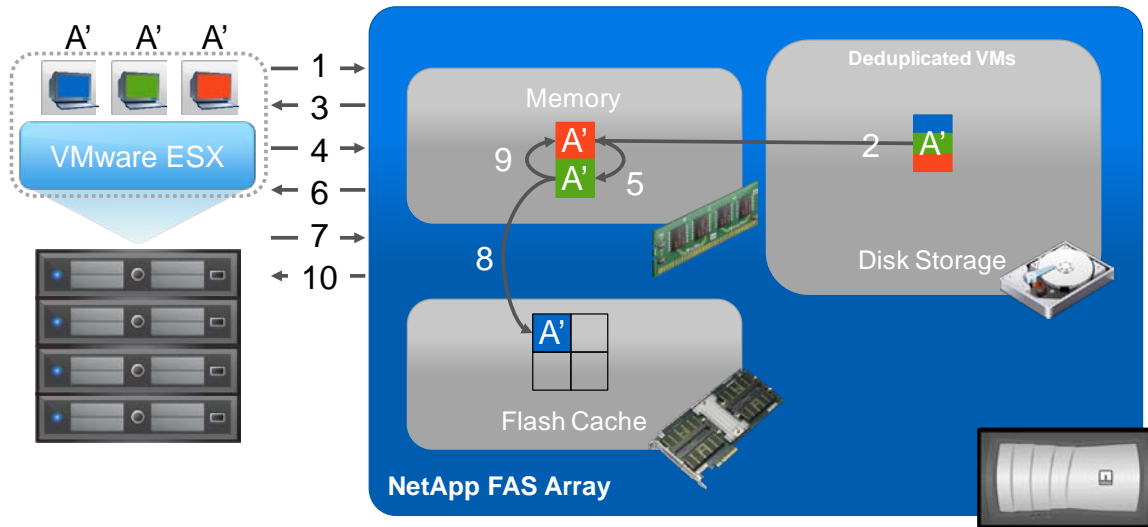

Figure 17) NetApp Flash Cache with deduplication.

1. Block A' (blue) requested from client.
2. Block A' (blue) read from disk to memory.
3. Block A' (blue) returned to client.
4. Block A' (green) requested from client.
5. Block A' (green) read from memory.
6. Block A' (green) returned to client.
7. Block A' (orange) requested from client.
8. Block A' (blue) evicted from memory to Flash Cache because memory is full and it was the first block.
9. Block A' (orange) read from memory.
10. Block A' (orange) returned to client.

FLEXSCALE

FlexScale is the tunable software component to Flash Cache. It is a licensed feature of Data ONTAP 7.3 or greater. FlexScale allows different caching modes to be used based on the type of workload. The different modes of caching are metadata only, normal user data, and low-priority blocks. Extensive scalable VMware View testing within the NetApp solution labs has shown that significant performance improvements can be gained by turning on metadata and normal user data caching modes in FlexScale.

To license and enable FlexScale:

1. Connect to the controller system's console, using either SSH, telnet, or serial console.
2. Check to see if the FlexScale license has already been installed by typing `license` and finding the line that says `flex_scale`:

```
license
```

3. If FlexScale is not licensed, you can license it by issuing the following command. If you do not have your license available, you can locate it within the NOW™ (NetApp on the Web) site: <http://now.netapp.com>.

```
license add <License_Key>
```

To change the FlexScale caching modes for use with VMware View workloads:

1. Connect to the controller system's console, using either SSH, telnet, or serial console.
2. Change the following options with the following commands. This turns on metadata and normal user data block caching. These are the recommended FlexScale settings for VDI.

```
options flexscale.enable on
options flexscale.normal_data_blocks on
```

3. You can verify these settings have been changed:

```
options flexscale
```

PREDICTIVE CACHE STATISTICS (PCS)

NetApp Predictive Cache Statistics (PCS) offers the ability to emulate large read cache sizes to measure their effect on system performance. PCS provides a means to approximate the performance gains of adding one or more Flash Cache modules to a system. PCS is configured in the same manner as Flash Cache and shares the same options for configuration.

This guide describes its configuration and use: <http://media.netapp.com/documents/tr-3801.pdf>.

7.7 SUMMARY OF TRANSPARENT STORAGE ARRAY CACHE IN A VMWARE VIEW ENVIRONMENT

Using NetApp Flash Cache allows customers to size their VMware View environments for normal operations and have the peaks handled by Flash Cache. Now companies can provide their end users with a cost effective *and* high-performing VMware View desktop.

THE TRANSPARENT STORAGE CACHE SHARING VALUE

- **Cache efficiency:** Deduplication occurs not only on disk but also in cache. Working sets of data are deduplicated so larger caches are not needed as in traditional legacy storage solutions.
- **Performance acceleration:** Blocks read from cache are served 10 times more quickly, as latency is reduced by a factor of 10.
- **Storage efficiency:** Allows you to reduce the spindle count even further as a large percentage of the read I/O requests are served up directly from transparent storage cache sharing.
- **Lower TCO:** NetApp transparent storage cache sharing and deduplication reduce rack space, power, and cooling.

NETAPP RECOMMENDATIONS

Since read I/O can be greatly reduced by using transparent storage cache sharing, NetApp recommends the use of Data ONTAP 7.3.1 or later. This version supports transparent storage cache sharing across NetApp's unified storage product line. When architecting large-scale solutions, the use of transparent storage cache sharing in Data ONTAP and Flash Cache should be used to extend the capabilities.

The net result of transparent storage cache sharing is that customers can buy less storage because of read cache and allow the disk to be used for write I/O. Because of deduplication and transparent storage cache sharing, the end-user experience is greatly enhanced.

7.8 SUMMARY

To summarize, a NetApp solution is very efficient in meeting both capacity and performance requirements.

NetApp storage efficiency capabilities reduce the spindle count required to meet the VDI capacity needs by 80% to 90%.

From an I/O perspective, VDI is very bursty. Under normal conditions, the read and write ratio varies; however, there are business-critical operations such as desktop patching, upgrading, and antivirus scanning that generate I/O bursts on the storage. I/O bursts, along with read and write operations, are the main deciding factor in VDI sizing. I/O bursts and read operations are handled very effectively by NetApp Flash Cache and dedupe. The end result is that with NetApp, customers require significantly fewer spindles to meet the requirements for read operations and I/O bursts as compared to traditional storage arrays. With read being offloaded by transparent storage cache sharing, write IOPS become the primarily deciding factor for spindle requirements on NetApp storage, but the NetApp solution still requires significantly fewer spindles than traditional storage arrays because of the WAFL and Data ONTAP write I/O optimization discussed earlier. Also, the same set of spindles can be used to host the user data on CIFS home directories, which do not have high IOPS requirements. This is possible because NetApp virtualizes disk I/O and capacity into large high-performing aggregates, which can be used on demand by individual VMs.

8 STORAGE SIZING BEST PRACTICES

Storage estimation for deploying VMware View solutions on NetApp includes the following steps:

1. Gather essential solution requirements
2. Perform performance-based and capacity-based storage estimation
3. Get recommendations on storage system physical and logical configuration

8.1 GATHER ESSENTIAL SOLUTION REQUIREMENTS

The first step of the storage sizing process is to gather the solution requirements. This is essential to size the storage system correctly in terms of the model and the number of required NetApp storage controllers, type and quantity of disk spindles, software features, and general configuration recommendations.

The key storage sizing elements are:

- Total number of VMs for which the system has to be designed (for example, 2000 VMs).
- The types and percentage of different types of desktops being deployed. For example, if VMware View is used, different desktop delivery models might require special storage considerations.
- Size per VM (for example, 20GB C: drive, 2GB data disk).
- VM OS (for example, Windows XP, Windows 7, and so on).
- Worker workload profile (type of applications on the VM, IOPS requirement, read-write ratio, if known).
- Number of years for which the storage growth has to be considered.
- Disaster recovery/business continuance requirements.
- Size of NAS (CIFS) home directories.

NetApp strongly recommends storing user data on NAS (CIFS) home drives. Using NAS home drives, companies can more efficiently manage and protect the user data and eliminate the need to back up the virtual desktops.

- For most of the VMware View deployments, companies might also plan to implement roaming profiles and/or folder redirection. For detailed information on implementing these technologies, consult the following documentation:
 - Microsoft [Configuring Roaming User Profiles](#)
 - NetApp [TR-3367: NetApp Systems in a Microsoft Windows Environment](#)
 - Microsoft [Configuring Folder Redirection](#)
- **VMware View considerations:** When implementing VMware View, decide on the following:
 - Types of desktops that will be deployed for different user profiles
 - Data protection requirements for different data components (OS disk, user data disk, CIFS home directories) for each desktop type being implemented
 - For automated desktop pools utilizing linked clone in persistent access mode, alternatively the user data and profile can be hosted on a separate “user data disk.” Being a vmdk file, it is important to decide on the user data disk size upfront. NetApp thin provisioning, deduplication, and VSC 2.0 Backup and Recovery data protection solution components can be leveraged to achieve the desired storage efficiency and data protection for the “user data disk.”

PERFORMANCE REQUIREMENTS

ESTIMATING ENVIRONMENT WORKLOAD

For proper storage sizing, it is critical to determine the IOPS requirement per virtual desktop. This involves analyzing how busy the virtual desktops will be and the percentage of users who are heavy workers (knowledge workers) versus light workers (for example, data entry workers). Important factors to be considered are:

- Hourly, daily, monthly, and quarterly user workload (best case and worst case scenarios)
- Percent reads versus writes (for example, 50% reads/50% writes or 33% reads/67% writes)
- Commonality of data and how well the data will deduplicate as this is directly related to cache efficiency
- Concurrency of user access; how many users will be working at the same time.

- Effect of antivirus operation (scanning and virus definition updates) requirements (frequency, schedules, and so on). For antivirus operations, one could either take a performance hit during scheduled AV operations and affect the end-user experience or appropriately design the VMware View solution to make the AV operations seamless. The first option is definitely not desirable. The second option is highly recommended. Long-term solution would be to implement a security technology such as [VMware VMsafe™](#) to help offload the virus scanning processing from the guest.
- Any recommendations specific to VMware on storage performance and IOPS requirements for best-case and worst-case situations for the customer environment. Also, VMware has provided some guidelines on IOPS per heavy and light user in the "[VMware VDI Storage Considerations](#)" white paper.

PERFORMANCE DATA COLLECTION METHODS

This performance data can be collected in many ways. If the VMware View environment is not new, one of the following methods could be used:

- **NetApp data collection tool.** The NetApp storage data collector and analyzer tool collect storage-specific performance counters from a range of Windows clients and help analyze the collected data so that they can be effectively used with the NetApp storage sizing tools. For details on how to obtain and run the tool in your environment, contact your NetApp account team.
- **VMware Capacity Planner data collector, Windows Logman tool, PlateSpin, and TekTools**
- **VDI Environment assessment tools: For example, Liquidware Labs, Lakeside Software**

In addition to the NetApp data collection tool, VMware Capacity Planner, Windows Logman, Perfmon, PlateSpin, or TekTools can be used to analyze the existing physical desktops within the environment to understand the I/O requirements.

Any of these methods can produce data that will assist in sizing the storage platform and the spindle count required to service the workload.

Example formula:

Total storage IOPS requirement = (sum of all max IOPS/number of desktops tested) x number of virtual desktops

Example:

During the performance data collection over 30 days, the max number of IOPS for 10 clients totaled 1,327. The customer is looking to deploy 100 seats. From this sample one can calculate the estimated IOPS requirement. From this number, as it is a maximum, one would have to decide the probability of all the clients reaching the max I/O requirement at the same time and adjusting an acceptable maximum, as architecting a solution for this concurrency might not be necessary. The average of all IOPS on all clients can be used to get a better understanding of the daily load:

13,270 total max IOPS = (1,327 sum of max IOPS/10 desktops tested) x 100 future virtual desktops

8.2 PERFORMANCE-BASED AND CAPACITY-BASED STORAGE ESTIMATION PROCESS

There are two important considerations for sizing storage for VMware View. The storage system should be able to meet both the performance and capacity requirements of the project and be scalable to account for future growth.

The steps for calculating these storage requirements are:

1. Determine storage sizing building block
2. Perform detailed performance estimation
3. Perform detailed capacity estimation
4. Obtain recommendations on the storage system physical and logical configuration

DETERMINE STORAGE SIZING BUILDING BLOCK

The purpose of this step involves determining the logical storage building block or POD size. This means deciding on the following parameters:

- Storage building block scope: NetApp recommends the VMware View storage sizing building block to be based on the number of datastores required per ESX cluster because it provides benefits of planning and scaling the storage linearly with the number of ESX clusters required for the solution.
- Determine the usable storage required per storage building block (per ESX cluster). For VMFS datastores, there can be multiple LUNs per flexible volume, where each LUN is a datastore. For NFS datastores, each volume can represent a datastore with more VMs as compared to VMFS datastores.
- Flexible volume layout across storage controllers: All the flexible volumes belonging to an ESX cluster should be evenly split across the two controllers of the hosting NetApp storage cluster. This is recommended for better performance, as the VMware View deployment scales out from one HA cluster to multiple, hundreds to thousands to tens of thousands of virtual desktops.

CONSIDER VSPHERE CONFIGURATION MAXIMUMS

Carefully review the VMware documentation on configuration maximums associated with the various storage-related parameters critical to the system design. For vSphere, review the document at www.vmware.com/pdf/vsphere4/r41/vsp_41_config_max.pdf.

The important configuration parameters critical to the design are:

- Number of virtual CPUs per server: This information is important to understand the maximum limit on the number of VMs that can be hosted on the physical server, irrespective of the number of cores per server.
- Number of virtual CPUs per core for VMware View workloads: This information will determine the upper limit on the numbers of VMs that can be supported per physical ESX host, but it cannot be more than the limit on number of virtual CPUs that can be hosted per server. Consult your VMware SE for a recommendation on the number of VMs that can be supported per ESX Server host.
- Number of VMs managed per vCenter instance: This information will help determine the maximum number of ESX hosts that can be managed by a single vCenter instance.
- Number of NAS datastores per cluster: This information is critical for sizing scalable virtual desktops on NFS datastores.
- Number of VMFS datastores configured per server (for FCoE/FC/iSCSI): This information is critical for sizing scalable VMware View solutions on VMFS datastores.
- Number of VMs per VMFS datastore: This information is critical for sizing scalable VMware View solutions on VMFS datastores. For NFS, there are no VMware recommendations on the maximum number of VMs per datastore.
- Number of hosts per HA/DRS cluster

These configuration parameters should help determine the following design parameters:

- Proposed number of VMs per ESX host
- Proposed number of ESX hosts per ESX cluster
- Proposed number of datastores per ESX cluster
- Proposed number of VMs per ESX cluster
- Number of ESX clusters managed by a vCenter instance
- Proposed number of VMs per datastore
- Total number of datastores required for the project

Provisioning fewer, denser datastores provides key advantages of ease of system administration, solution scalability, ease of managing data protection schemes, and effectiveness of NetApp deduplication.

DECIDE ON STORAGE PROTOCOL

The two shared storage options available for VMware View are:

- VMFS-based datastores over FCoE, FC, or iSCSI
- NFS-based datastores

NetApp is a true unified multiprotocol storage system that has the capability to serve storage for both shared storage options from a single storage cluster without the use of additional SAN or NAS gateway devices.

Both of these are viable and scalable options for VMware View. Consider reading [NetApp TR-3808: VMware vSphere and ESX 3.5 Multiprotocol Performance Comparison Using FC, iSCSI, and NFS](#) for results from a technical performance study conducted jointly by NetApp and VMware on different storage protocols. Also, perform a cost benefit analysis for your environment and decide on the storage protocol to be used. The key NetApp value proposition for VMware View holds true across all the protocols.

PERFORM DETAILED PERFORMANCE ESTIMATION

This step involves estimating the total number of disk IOPS and Flash Cache modules required for the VMware View solution based on the requirements. Write I/O optimization with coalescing multiple write operations as single IOPS and transparent storage cache sharing capabilities available in NetApp solution help significantly reduce the amount of data disks required. The calculations are performed based on the IOPS requirement per VM, version of Data ONTAP, transparent storage cache sharing, and customer environment workload characteristics. For getting detailed estimation on savings achieved for your environment, contact your NetApp account team. The output of this step includes:

- Total number of Flash Cache modules required
- Total IOPS required in order to meet the performance needs
- Percentage of the total IOPS that require data disks considering the disk savings with write I/O optimization, NetApp transparent storage cache sharing, and Flash Cache capabilities

VMware View considerations: This step is applicable to all the six virtual desktop types available in VMware View 4.5 and can help reduce the total number of spindles required.

PERFORM DETAILED CAPACITY ESTIMATION

Figure 18 describes the various steps involved in the capacity-based storage estimation process. Each of these steps is discussed in detail in the following sections.

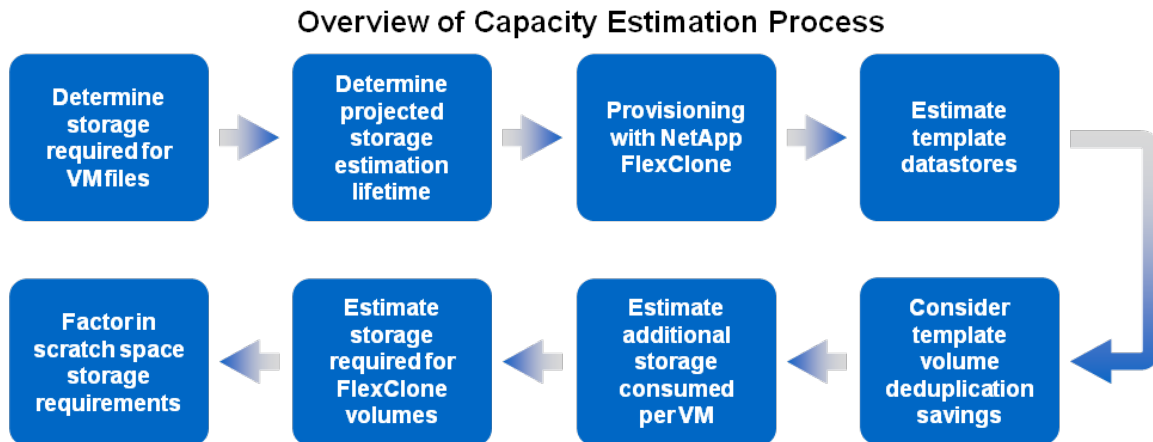

Figure 18) Overview of capacity estimation process.

DETERMINE STORAGE REQUIRED FOR VM FILES

There are several files associated with each VM, and these files require shared storage in addition to the actual VM.

Table 6) VMware file listing.

Files	Purpose	Storage Required
.vmdk	Two VMDK files that make up a VM. The –flat.vmdk file is the actual data disk, and the .vmdk file is the descriptor file that describes the disk geometry of the –flat file, (<2K). If considering using VMware Snapshot copies, the –delta.vmdk files must be considered as a part of the storage requirements.	Size of the VM (for example, 20GB)
.vswp	Each VM will have its own VM-specific .vswp file based on the amount of memory assigned to that VM. For example, if you are sizing for 100 VMs, each with 1GB of RAM, then you need to plan for 100GB storage for .vswp. <i>NetApp recommendation is to move the vswp file to a different datastore if Snapshot copies are being considered. See TR-3749: NetApp and VMware vSphere Storage Best Practices for more details on this recommendation.</i>	Amount of memory assigned to each VM (for example, 1GB/VM)
.vmsd/.vmsn	A VMSN file stores the exact state of the VM when the Snapshot copy was created. A VMSD file stores information and metadata about Snapshot copies. It is important that space for these files be accounted for if temporary Snapshot copies have to be created. Consider the number of Snapshot copies, how long they are likely to be kept, and how much they would grow. If the Snapshot copies also include memory, then the space requirements can grow very quickly.	The total space required for the non-VMDK files might be 5% if the vswp is moved to a separate datastore. It will be higher (15%) if the vswp is located on the same datastore. This number will be even more if there are specific requirements for creating and retaining VMware Snapshot copies.
.vmx	A vmx file is the primary configuration file for a VM and stores the important configuration parameters.	
.vmxf	This is a supplemental configuration file in text format for VMs that are in a team. Note that the .vmxf file remains if a VM is removed from the team.	
.vmss	This is the suspended state file, which stores the state of a suspended VM.	
.nvram	This is the file that stores the state of the VM BIOS.	
.log	The log files contain information on the VM activity and are useful in troubleshooting VM problems.	
Total storage for VM files		

VMware View considerations:

- If you are planning to implement VMware View, for calculation purposes, it is important to understand the total space required per VM for individual desktops, manual desktop pool, and automated desktop pool leveraging full clones. The actual storage required (output of the storage estimation process) will be far less considering the NetApp solution space efficiency components.
- For “automated desktop pool” leveraging linked clones, estimate the space required by all the files that make up the parent VM, replica VMs, OS data disks, user data disks, and vswap, considering the policies for linked clone desktop refresh, recompose, and rebalance. For further details, refer to the [VMware View System Administrator Guide](#).

DETERMINE PROJECTED STORAGE ESTIMATION LIFETIME

Determine the total number of years for which the storage growth has to be factored in. This is important because when using the NetApp FlexClone and deduplication solution components, initially the VMs hosted in the FlexClone volumes will not consume any space. But the new writes will require storage to commit the writes.

PROVISIONING WITH FLEXCLONE

FlexClone provides simple, rapid, space-efficient, zero-upfront cost provisioning of VMware View datastores using NetApp VSC 2.0 and the provisioning and cloning capabilities. FlexClone technology uses the power of NetApp Snapshot technology to rapidly provision VMFS or NFS datastores. The process of provisioning with FlexClone involves creating a template datastore and making multiple FlexClone volumes of the datastore depending on the total number of VMs required. This template datastore is the base of the FlexClone volumes. For example, if you have an NFS volume with 200 VMs contained within the volume/datastore, leverage FlexClone to provision additional volumes of 200 VMs within seconds. Using the power of FlexClone you can eliminate the need to clone each VM sequentially, which can be a very time-consuming process, especially when provisioning hundreds or thousands of VMs. For more information on FlexClone technology concepts, see [NetApp TR-3347: FlexClone Volumes: A Thorough Introduction](#).

VMware View considerations: If you are planning to implement VMware View, the use of NetApp FlexClone technology is applicable to manual desktop pools. For “automated desktop pool” leveraging full clones, estimate the space required by each full clone. Automated desktop pools can also benefit from the use of VMware linked clones.

ESTIMATE TEMPLATE VOLUMES/DATASTORES

The next step is to size the template datastore/volumes appropriately. The template datastore is a datastore that will be used as a base that will be cloned quickly and efficiently using FlexClone. Using template datastores will provide the ability to utilize the provisioning benefits associated with FlexClone. From an overall management and scalability perspective, consider splitting the datastores for each ESX cluster equally across the two controllers of the NetApp storage system. This would require two template datastores (one per NetApp controller) per ESX cluster. It also helps multiple ESX clusters have no dependencies on one another for sharing storage. When using NetApp VSC 2.0 provisioning and cloning with Data ONTAP 7.3.1 and higher, file-level FlexClone can be leveraged to rapidly make space-efficient clones inside a template volume.

This example demonstrates the sizing of a template volume for an NFS environment in which we are creating one datastore with 200 VMs. We have budgeted 10% overhead within the template volume.

Example formula 1 (Data ONTAP 7.3.1 or higher):

Size of template volume = [(space required per VM) x (number of datastores per flexible volume)] + 10% buffer space

Example:

28GB template volume (approx.) = [(25GB per VM) x (1 datastore per volume)] + 10%

Example formula 2 (Data ONTAP 7.3 or earlier):

Size of template volume = [(space required per VM) x (number of VMs per datastore) x (number of datastores per flexible volume)] + 10% buffer space

Example:

5.5TB template volume = [(25GB per VM) x (200 VMs per datastore) x (1 datastore per volume)] + 10%

Note: The buffer space in formula 2 is only a temporary requirement so that the template volume doesn't get 100% full when all the VMs are added in the datastore. Set the Snapshot reserve to zero and disable the default Snapshot schedule.

CONSIDER TEMPLATE VOLUME DEDUPLICATION SAVINGS

Once the storage required per template volume is determined, estimate the deduplication savings. For flexible volumes with multiple identical VMs, the deduplication savings will be very high as the OS part of all the VMs in the volume is almost identical.

Note: For deployments leveraging Data ONTAP 7.3.1 or higher, the template datastore is already deduplicated as a result of FlexClone file-level cloning inside the template datastore. Therefore, factoring in deduplication savings is valid only for deployments with Data ONTAP 7.3 or lower.

For VMware View on NetApp environments, we estimate the initial deduplication savings to be at least 80% to 95% for the template datastores as all virtual machines within the datastore are identical, given that there are more than eight VMs per template datastore.

For more general information on deduplication, refer to [NetApp TR-3505: NetApp Deduplication for FAS, Deployment and Implementation Guide](#).

The output of this step will give the storage required per template flexible volume after the deduplication savings have been factored in (for Data ONTAP 7.3 or lower). It might be also necessary to factor in additional space for Snapshot reserve. The Snapshot reserve can be less for environments where the template volume will not change much and few Snapshot copies will be retained. Consult a NetApp SE for recommendations for your data protection requirements.

Example formula:

Deduplicated template volume size = [(size of template FlexVol volume) x (% deduplication)] x % Snapshot reserve space

Example:

121GB template volume size = [(5.5TB FlexVol volume) x (98% savings)] x 10%

VMware View considerations: If you are planning to implement VMware View, the use of NetApp deduplication for template datastore is applicable to manual desktop pools. Deduplication scenarios for automated desktop pools leveraging linked clones are discussed later in the document.

ESTIMATE ADDITIONAL STORAGE CONSUMED PER VM

All the VMs hosted on the flexible volumes provisioned with FlexClone will initially access the same data blocks as the deduplicated template volume. However, the new writes for every VM will consume new storage blocks. Over the years for which the storage growth has to be considered, every FlexClone volume will have consumed some new storage space.

Calculate the projected storage consumed by each VM over this time period, across all the VM storage elements (OS/system files, data files on C drive) and non-VMDK files in the datastore:

1. Projected new storage consumed per year (GB) for OS part of the VM.
2. Projected new storage consumed per year (GB) for data part of the VM.
3. Projected new storage consumed per VM for non-VMDK files in the datastore.
4. Multiply each of these elements with the total number of years for which the storage estimation is being done.

Example formula:

Total additional storage/VM for OS part of the C drive = (yearly OS delta) x number years

Total additional storage/VM for data part of C drive = (yearly data delta) x number years

Total additional storage/VM for non-VMDK files in the datastore = (yearly non-VMDK files delta) x number years

Example:

6GB total additional storage/VM for OS = (2GB OS) x 3 years

15GB total additional storage/VM for data = (5GB data) x 3 years

0.9GB total additional storage/VM for data = (300MB data) x 3 years

VMware View considerations: If you are planning to implement VMware View, considerations should be given to each desktop delivery model.

- The method described above is valid for VMs being used in the “individual desktops” and “manual desktop pool” desktop delivery models.
- For automated desktop pools, leveraging linked clone, considerations should be given to the linked clone desktop disk usage.
 - For the VMs provisioned using linked clones in persistent access mode, based on your user profiles, determine how much will be growth of the OS data disks between the refresh, recompose, and/or rebalance operations.
 - Also, for the VMs provisioned using linked clones in persistent access mode, determine the projected growth of the “user data disk” over the lifespan of the user accessing this disk. It is important to decide on the size of the vmrk file representing the user data disk upfront.
 - For VMs provisioned using linked clones in nonpersistent access mode, based on your user profile, determine how much will be the OS data disk growth.
- For further details, refer to the [View Administration Guide](#).

ESTIMATE STORAGE REQUIRED FOR FLEXCLONE VOLUMES (CONSIDERING DEDUPE SAVINGS)

The storage required per FlexClone volume can be obtained by multiplying the results of the previous step with the total number of VMs planned per FlexClone volume and discounting the deduplication savings. This will also be a factor of the number of VMs hosted per FlexClone volume. The deduplication savings for the OS image part of the C: drive will be higher because all the patches and upgrades applied to each VM will essentially be the same. A conservative number for the OS part would be between 50% and 70% (based on existing customer deployments and NetApp solutions lab validation). However, the deduplication savings for the data part of the C: drive might not be as dense as the OS images as it is unique to each individual VM. A conservative number for the data part would be between 20% and 50%, as is seen in CIFS home directory deduplication savings for customer deployments.

Example formula:

$$\text{Per FlexVol volume storage consumption} = [(\text{total additional storage per VM for OS}) \times (\text{number of VMs per FlexClone volume}) \times \text{deduplication savings}] + [(\text{total additional storage per VM for data}) \times (\text{number of VMs per FlexClone volume}) \times \text{deduplication savings}] + [(\text{total additional storage/VM for non-VMDK files in the datastore}) \times (\text{number of VMs per FlexClone volume}) \times \text{deduplication savings}]$$

Example:

$$1950\text{GB per FlexVol volume storage consumption} = (6\text{GB} \times 200 \text{ VMs}) \times 70\% \text{ savings} + (15\text{GB} \times 200 \text{ VMs}) \times 50\% \text{ savings} + (0.9\text{GB} \times 200 \text{ VMs}) \times 50\% \text{ savings}$$

For environments in which Snapshot and/or mirroring will not be used for the VM C drives, NetApp recommends setting the Snapshot reserve to 0% and disabling the Snapshot schedule. If Snapshot copies or SnapMirror will be used, the snap reserve should be set to a value that will allow for the planned number of Snapshot copies.

To adjust Snapshot reserve and Snapshot schedule:

1. Connect to the controller system’s console, using either SSH, telnet, or serial console.
2. Set the volume Snapshot reserve:

```
snap reserve <vol-name> ##
```
3. Set the volume Snapshot schedule:

```
snap sched <vol-name> 0 0 0
```

The output of this step is the total usable storage required by each FlexClone volume. This number can be extrapolated to calculate the total usable storage required for the template volumes and associated FlexClone volumes per ESX cluster and ultimately for the entire environment, depending on the total number of ESX clusters required. Again, NetApp recommends splitting the datastores for each ESX cluster across the two controllers of the NetApp storage system.

VMware View considerations:

- The considerations in this step are valid for VMs provisioned using NetApp VSC provisioning and cloning capability (leveraging FlexClone technology) configured either as individual desktops or as part of the manual desktop pool.
- For VMs provisioned as part of automated desktop pools using VMware full clones, 50% to 90% storage savings can be achieved using NetApp deduplication. Consider these savings in the storage estimation process.
- For VMs provisioned as part of automated desktop pools using VMware linked clones, significant storage savings can be achieved for the “user data disk” using NetApp deduplication. A conservative number to consider would be between 20% and 50%, as seen for home directories.

FACTOR IN SCRATCH SPACE STORAGE REQUIREMENTS

If required, factor in additional storage (scratch space) for test and dev operations or any other reason. This step is not mandatory, but highly recommended (for future or last-minute design changes).

SUMMARY OF CAPACITY-BASED STORAGE ESTIMATION PROCESS

The capacity calculations have provided guidance to the following essential storage architecture elements:

- Total number of datastores per template volume
- Total number of FlexClone volumes per template volume
- Total storage required per template volume
- Total storage required per FlexClone volume
- Total storage required for each template and FlexClone volume combination
- Total number of template and FlexClone volume combinations
- Total storage required for all the template and FlexClone volume combinations
- All the storage considerations for different desktop delivery models available in VMware View

STORAGE CONSIDERATIONS FOR DESKTOP DELIVERY MODELS IN VMWARE VIEW

Table 7 summarizes the storage sizing considerations for different desktop deployment models in VMware View, specifically with linked clones.

Table 7) Summary of storage considerations for desktop delivery models.

Pool Type	Virtual Desktop Provisioning Method	Generic Recommendations	Special Storage Considerations
Manual Desktop Pool	NetApp VSC Provisioning and Cloning Capability (FlexClone)	<ul style="list-style-type: none"> • Determine the types of desktops that will be deployed for different user profiles • Determine data protection requirements for different data components (OS disk, user data disk, CIFS home directories) for each desktop type 	Primary objective of the discussion in this section of the document
Automated Desktop Pool	VMware View Composer (Full Clones)	<ul style="list-style-type: none"> • Consider reading the View Administration Guide 	<ul style="list-style-type: none"> • Estimate the space required by each full clone • Leverage NetApp deduplication to achieve 50% to 90% storage efficiency • Consider the storage savings in the storage estimation process
	VMware View Composer (Linked Clones)		<ul style="list-style-type: none"> • Estimate the space required by all the files that make up the parent VM, replica, OS data disks, user data disks, and vswap considering the policies for linked clone desktop refresh, recompose, and rebalance. • Consider space in each datastore for different replica(s).

Pool Type	Virtual Desktop Provisioning Method	Generic Recommendations	Special Storage Considerations
			<p>The number of replica(s) in a datastore will depend on the total number of parent VMs and Snapshot copies to which the active linked clone VMs in each datastore are anchored.</p> <ul style="list-style-type: none"> • Decide on your storage overcommit policies to determine the number of linked clone VMs that can be hosted in a datastore. For detailed information, refer to the View Administration Guide. • Give consideration to the linked clone desktop disk usage as in some instances, the OS data disk can grow to the size of the parent VM (for details, see the View Administration Guide). • For the persistent access mode, based on your user profiles, determine how much will be the growth of the OS data disks between the refresh, recompose, and/or rebalance operations. • For persistent access mode, determine the projected growth of the user data disk over the lifespan of the user accessing this disk. This is important to decide in the design phase of the project. • For persistent access mode, significant storage savings can be achieved for the user data disk using NetApp thin provisioning and data deduplication. A conservative number to consider would be between 20% and 50%, as seen for home directories. • For persistent access mode, NetApp VSC backup and recovery data protection solution can be leveraged to achieve the desired storage efficiency and data protection for the “user data disk.” • For nonpersistent access mode, based on your user profile, determine the growth rate of the OS data disk. Consider policies such as deleting VM after first use to conserve storage space.

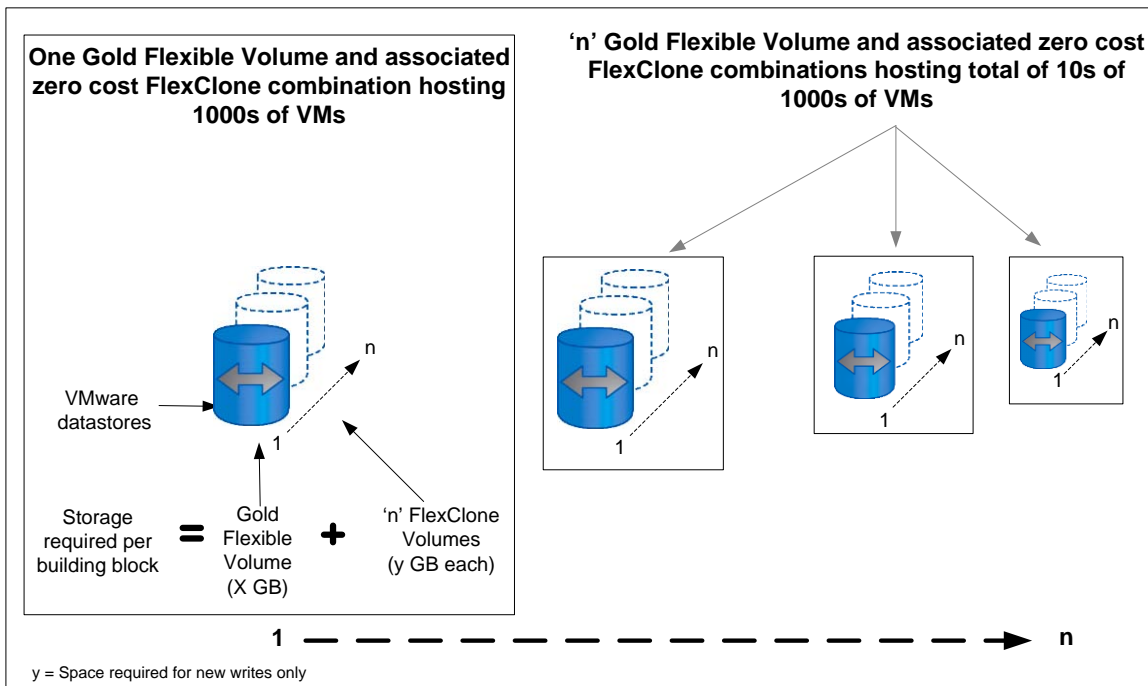

Figure 19) FlexClone scalability.

8.3 GETTING RECOMMENDATIONS ON STORAGE SYSTEM PHYSICAL AND LOGICAL CONFIGURATION

Provide the total capacity and performance requirements to the NetApp SE and obtain appropriate storage system configuration. If required, NetApp can help you in each phase of the process discussed above. NetApp has detailed sizing tools specific to VMware View that can help architect VMware View deployments of any scale. The tools are designed to factor in all the NetApp storage efficiency and performance acceleration components discussed earlier.

This step also involves planning the logical architecture (the total number of template and the associated FlexClone volumes that should be provisioned per aggregate). The recommendation is to provision fewer large aggregates over more, smaller aggregates. The advantages to larger aggregates are that the I/O has more disks to write across, therefore increasing the performance of all volumes contained within the aggregate. Based on the estimated volume size from the capacity calculations section earlier, determine the number of template and associated FlexClone volumes that can be hosted in the largest possible aggregate. It is also a good idea to leave some room to grow the aggregates to handle situations when unexpected growth occurs. Also, disable scheduled aggregate Snapshot copies and set the aggregate snap reserve to zero. Make sure the data disk in the aggregate satisfies the performance requirements for the proposed number of VMs for volumes to be hosted in the aggregate.

9 STORAGE ARCHITECTURE BEST PRACTICES

In a VMware View environment, the availability and performance of the storage infrastructure are very critical because thousands of users will be affected by storage outages or performance issues. Thus the storage architecture must provide the level of availability and performance typical for business-critical applications. NetApp has all the software and hardware solutions that address the availability and performance for large, scalable VMware View environments. A complete VMware View deployment guide can be found [NetApp TR-3770: 2,000-Seat VMware View on NetApp Deployment Guide Using NFS](#).

9.1 STORAGE SYSTEM CONFIGURATION BEST PRACTICES

This section of the solution guide provides a high-level overview of the components and features that should be considered when deploying a VMware View infrastructure on NetApp. For detailed information on storage resiliency, refer to the following TRs:

- [NetApp TR-3437: Storage Best Practices and Resiliency Guide](#)
- [NetApp TR-3450: Active-Active Controller Overview and Best Practices Guidelines](#)

BUILDING A RESILIENT STORAGE ARCHITECTURE

- **Active-active NetApp controllers.** The controller in a storage system can be a single point of failure if not designed correctly. Active-active controllers provide controller redundancy and simple automatic transparent failover in the event of a controller failure to deliver enterprise-class availability. Providing transparent recovery from component failure is critical as all desktops rely on the shared storage. For more details, visit www.netapp.com/us/products/platform-os/active-active.html.
- **Multipath high availability (HA).** Multipath HA storage configuration further enhances the resiliency and performance of active-active controller configurations. Multipath HA—configured storage enhances storage resiliency by reducing unnecessary takeover by a partner node due to a storage fault, improving overall system availability and promoting higher performance consistency. Multipath HA provides added protection against various storage faults, including HBA or port failure, controller-to-shelf cable failure, shelf module failure, dual intershell cable failure, and secondary path failure. Multipath HA helps provide consistent performance in active-active configurations by providing larger aggregate storage loop bandwidth. For more information, visit <http://media.netapp.com/documents/tr-3437.pdf>.
- **RAID data protection.** Data protection against disk drive failure using RAID is a standard feature of most shared storage devices, but with the capacity and subsequent rebuild times of current hard drives where exposure to another drive failure can be catastrophic, protection against double disk failure, is now essential. NetApp RAID-DP is an advanced RAID technology that is provided as the default RAID level on all FAS systems. RAID-DP provides performance that is comparable to that of RAID 10, with much higher resiliency. It provides protection against double disk failure as compared to RAID 5, which can only protect against one disk failure. NetApp strongly recommends using RAID-DP on all RAID groups that store VMware View data. For more information on RAID-DP, refer to NetApp white paper 3298 at www.netapp.com/us/library/white-papers/wp_3298.html.
- **Remote LAN management (RLM) card.** The RLM card improves storage system monitoring by providing secure out-of-band access to the storage controllers, which can be used regardless of the state of the controllers. The RLM offers a number of remote management capabilities for NetApp controllers, including remote access, monitoring, troubleshooting, logging, and alerting features. The RLM also extends AutoSupport™ capabilities of the NetApp controllers by sending alerts or "down storage system" notification with an AutoSupport message when the controller goes down, regardless of whether the controller can send AutoSupport messages. These AutoSupport messages also provide proactive alerts to NetApp to help provide faster service. For more details on RLM, visit http://now.netapp.com/NOW/download/tools/rlm_fw/info.shtml.
- **Networking infrastructure design (FCoE, FC, or IP).** A network infrastructure (FCoE, FC, or IP) should have no single point of failure. A highly available solution includes having two or more FC/FCoE or IP network switches; two or more CNAs, HBAs, or NICs per host; and two or more target ports or NICs per storage controller. In addition, if using Fibre Channel, two independent fabrics are required to have a truly redundant architecture.

For additional information on designing, deploying, and configuring vSphere SAN and IP networks, refer to [TR-3749: NetApp and VMware vSphere Storage Best Practices](#).

TOP RESILIENCY BEST PRACTICES

- Use RAID-DP, the NetApp high-performance implementation of RAID 6, for better data protection.
- Use multipath HA with active-active storage configurations to improve overall system availability as well as promote higher performance consistency.
- Use the default RAID group size (16) when creating aggregates.
- Allow Data ONTAP to select disks automatically when creating aggregates or volumes.
- Use the latest Data ONTAP general deployment release available on the NOW site.
- Use the latest storage controller, shelf, and disk firmware available on the NOW site.
- Disk drive differences are FC, SAS, SATA disk drive types, disk size, and rotational speed (RPM).

- Maintain two hot spares for each type of disk drive in the storage system to take advantage of Maintenance Center.
- Do not put user data into the root volume.
- Replicate data with SnapMirror or SnapVault for disaster recovery (DR) protection.
- Replicate to remote locations to increase data protection levels.
- Use an active-active storage controller configuration (clustered failover) to eliminate single points of failure (SPOFs).
- Deploy SyncMirror® and RAID-DP for the highest level of storage resiliency.

For more details, refer to [NetApp TR-3437: Storage Best Practices and Resiliency Guide](#).

BUILDING A HIGH-PERFORMANCE STORAGE ARCHITECTURE

A VMware View workload can be very I/O intensive, especially during the simultaneous boot up, login, and virus scan within the virtual desktops. These first two workloads are commonly known as a “boot storm” and “login storms.” A boot storm, depending on how many ESX Servers and guests are attached to the storage, can create a significant performance effect if the storage is not sized properly. A boot storm can affect both the speed in which the VMware desktops are available to the customer and overall customer experience. A “virus scan storm” is similar to a boot storm in I/O but might last longer and can significantly affect customer experience. A virus scan storm is when a virus scan within the guest is initiated on all the clients at once.

Due to these factors, it is important to make sure that the storage is architected in such a way as to eliminate or decrease the effect of these events.

- **Aggregate sizing.** An aggregate is NetApp’s virtualization layer, which abstracts physical disks from logical datasets, which are referred to as flexible volumes. Aggregates are the means by which the total IOPS available to all of the physical disks are pooled as a resource. This design is well suited to meet the needs of an unpredictable and mixed workload. NetApp recommends that whenever possible a small aggregate should be used as the root aggregate. This aggregate stores the files required for running and providing GUI management tools for the storage system. The remaining storage should be placed into a small number of large aggregates. The overall disk I/O from VMware environments is traditionally random by nature, so this storage design gives optimal performance because a large number of physical spindles are available to service I/O requests. On smaller storage systems, it might not be practical to have more than a single aggregate, due to the restricted number of disk drives on the system. In these cases, it is acceptable to have only a single aggregate.
- **Disk configuration summary.** When sizing your disk solution, consider the number of desktops being served by the storage controller/disk system and the number of IOPS per desktop. This way one can make a calculation to arrive at the number and size of the disks needed to serve the given workload. Remember, keep the aggregates large, spindle count high, and rotational speed fast. When one factor needs to be adjusted, Flash Cache can help eliminate potential bottlenecks to the disk.
- **Flexible Volumes.** Flexible volumes contain either LUNs or virtual disk files that are accessed by VMware ESX Servers. NetApp recommends a one-to-one alignment of VMware datastores to flexible volumes. This design offers an easy means to understand the VMware data layout when viewing the storage configuration from the storage system. This mapping model also makes it easy to implement Snapshot backups and SnapMirror replication policies at the datastore level, because NetApp implements these storage side features at the flexible volume level.
- **LUNS.** LUNs are units of storage provisioned from a NetApp storage controller directly to the ESX Servers. The LUNs presented to the ESX Server are formatted with the VMware File System (VMFS). This shared file system is capable of storing multiple virtual desktops and is shared among all ESX Servers within the HA/DRS cluster. This method of using LUNs with VMFS is referred to as a VMFS datastore. For more information, see the VMware Storage/SAN Compatibility Guide for vSphere ESX 4 and 4i.
- **Flash Cache.** Flash Cache enables transparent storage cache sharing and improves read performance and in turn increases throughput and decreases latency. It provides greater system scalability by removing IOPS limitations due to disk bottlenecks and lowers cost by providing the equivalent performance with fewer disks. Leveraging Flash Cache in a dense (deduplicated) volume allows all the shared blocks to be accessed directly from the intelligent, faster Flash Cache versus disk. Flash Cache provides great benefits in a VMware View environments, especially during a boot storm, login storm, or virus storm, as only one copy of deduplicated data will need to be read from the disk (per volume). Each subsequent access of a shared block will be read from Flash Cache and not from disk, increasing performance and decreasing latency and overall disk utilization.

10 CONFIGURING VSC 2.0 PROVISIONING AND CLONING

1. Log into vCenter using the vCenter client.



2. Select NetApp from the Home screen of the vCenter client.

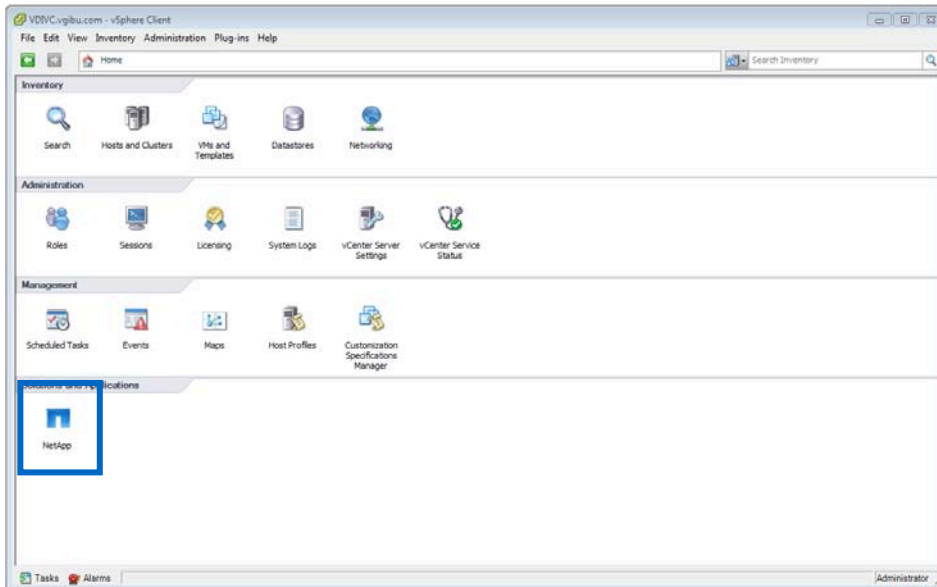

3. If you are launching VSC 2.0 for the first time, accept the security alert by clicking **Yes**. You also can view and install the certificate at this time.



4. Select the storage controllers from the tabs listed.

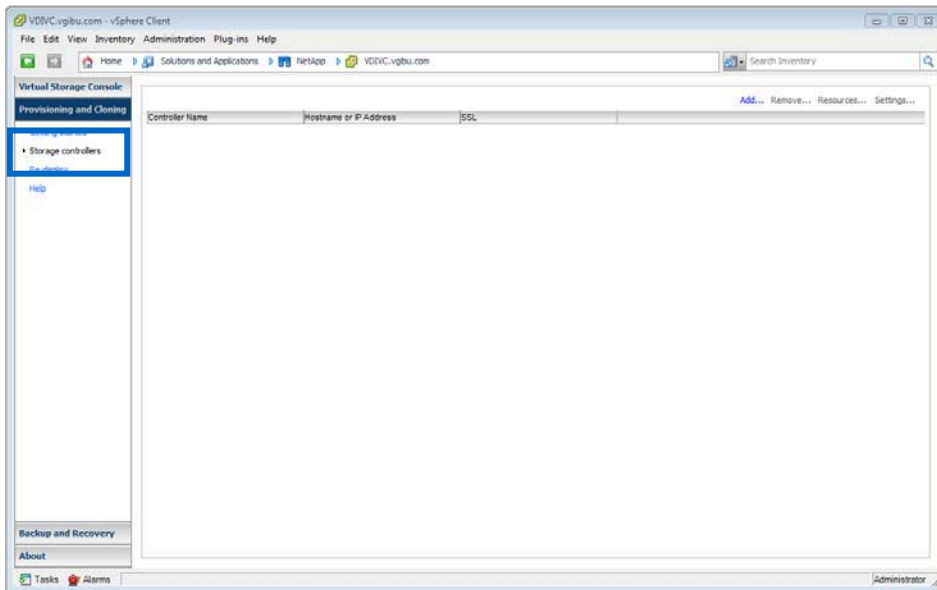

5. Select the “Storage controllers” tab and select **Add**.

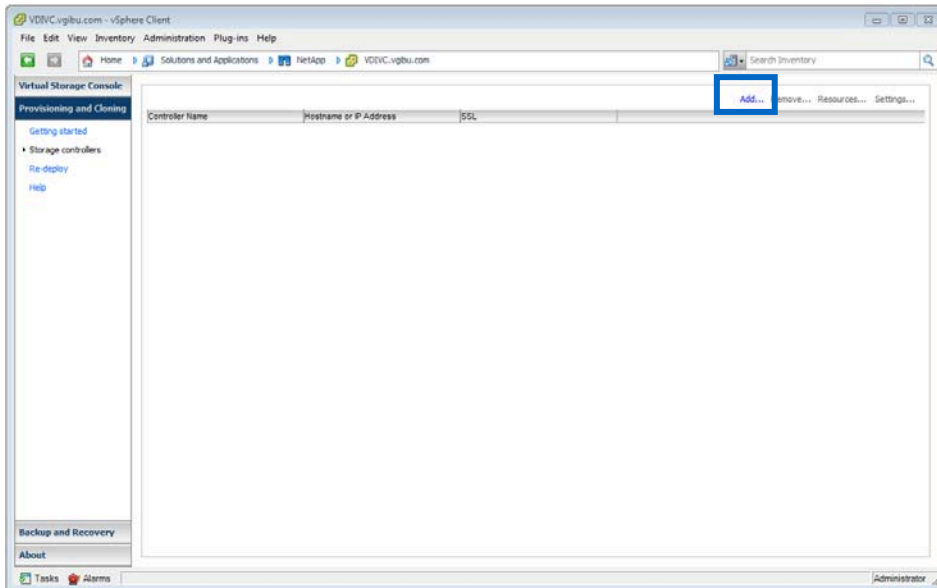

6. Enter the IP address of the storage controller as well as the user name and password. If SSL has been enabled on the controller, select “Use SSL.” If you are unsure if SSL has been enabled, check the box and try to connect. If enabled, you will connect; if not, it will reject the connection. Then uncheck the box and try again.

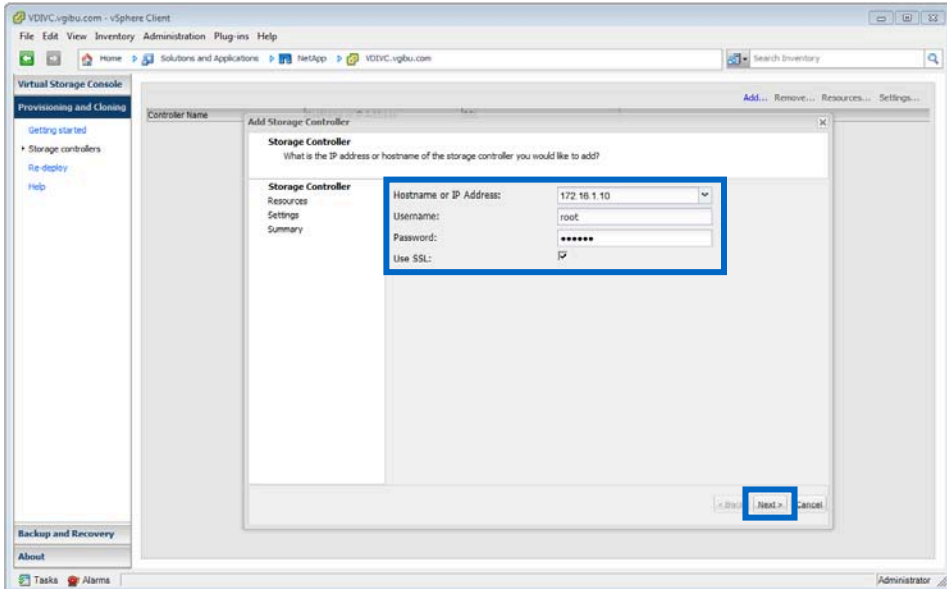

- By default the interfaces, volumes, and aggregates are all allowed and are on the right. To prohibit the use of an interface, volume, or aggregate, select it and click the single left arrow. Once you have completed selecting all the appropriate interfaces, select Next.

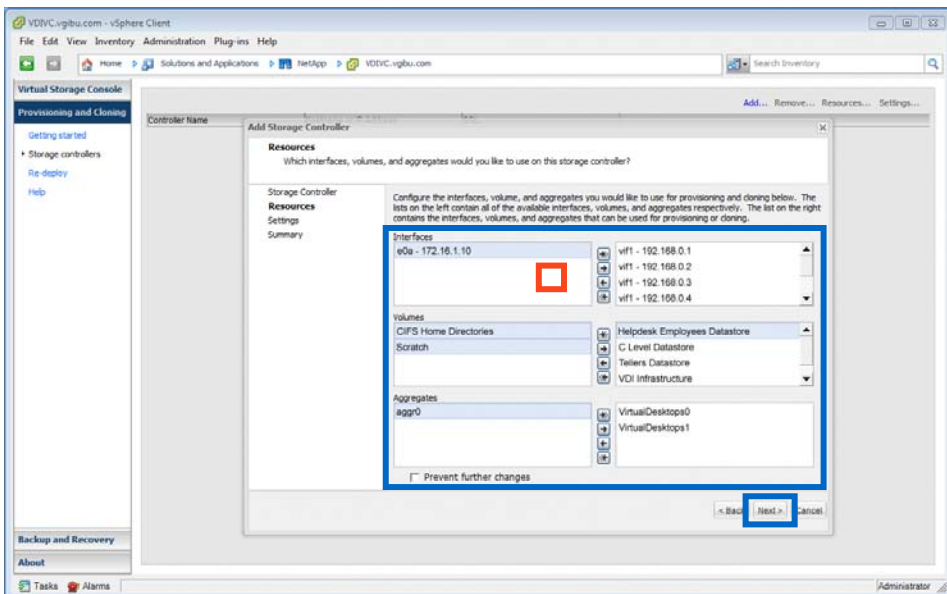

- After configuring the allowed interfaces, volumes, and aggregates, review the configuration and click Apply. This will complete the configuration of the VSC provisioning and cloning capability.

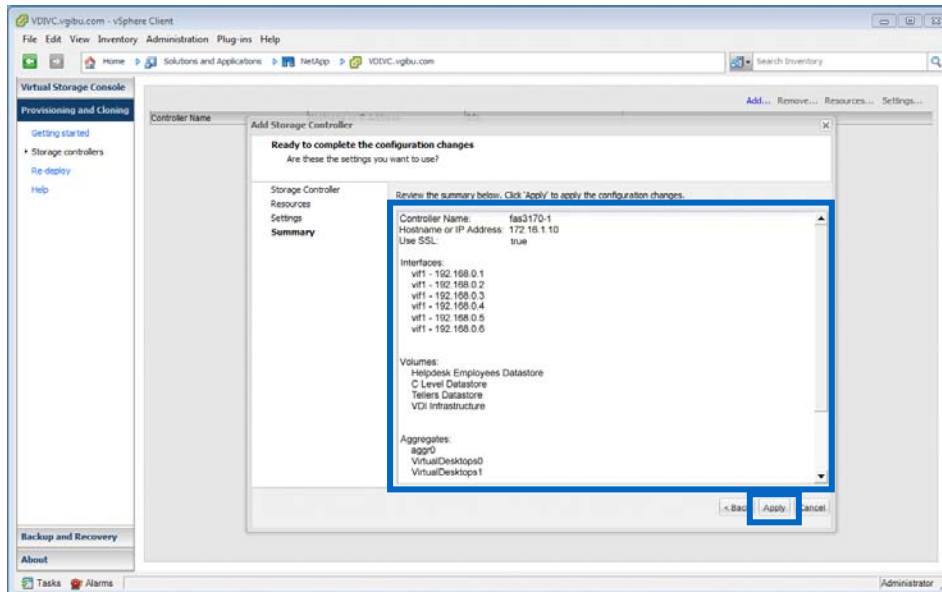

11 DEPLOYING NETAPP SPACE-EFFICIENT VM CLONES

This chapter demonstrates the steps involved in deploying NetApp space-efficient clones using the NetApp VSC provisioning and cloning capability. The VSC allows administrators to leverage the power of NetApp FlexClone (both file and volume) and redeploy virtual machines after patching or software updates, thin provisioning, and deduplication management capabilities directly from the VMware vCenter GUI. Integrating NetApp capabilities into VMware vCenter allows VMware administrators to provision or re-provision one to thousands of new virtual machines in minutes without requiring the administrator to log into the storage. The VSC utilizes both the NetApp and VMware APIs to create a robust, fully supported solution. No end user customization or scripting is required. In this section, we will demonstrate how to properly configure the virtual machine template and deploy one or thousands of virtual machines right from the VMware vCenter interface.

Note: The VSC 2.0 supports Windows XP, Windows 7, Windows 2003 and Windows 2008. The VSC not only is for deploying virtual desktops but also can easily be used for deploying virtual servers. More details on supported operating systems can be found in the [Provisioning and Cloning Administration Guide](#).

11.1 OVERVIEW OF DEPLOYING NETAPP SPACE-EFFICIENT CLONES

NetApp Provisioning and Cloning Deployment Overview

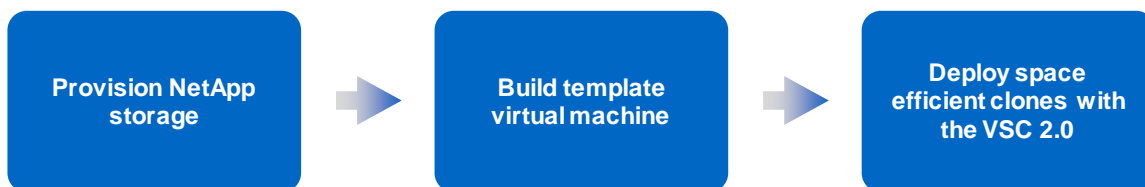

Figure 20) NetApp VSC 2.0 deployment overview.

PROVISION NETAPP STORAGE

This step involves preparing the NetApp storage for provisioning VMs. The detailed steps involved are as follows:

1. Create aggregate.
2. Create template datastore with the VSC 2.0.

BUILD TEMPLATE VIRTUAL MACHINE

This step involves creating and customizing the template VM that will be used to deploy the VMs within the environment. The detailed steps involved are as follows:

1. Create virtual machine for use as a template.
2. For Windows XP virtual machines, perform guest partition alignment for the empty vmdk as per instructions in [TR-3747](#). For Windows 7, no guest partition alignment is necessary as the default partition is properly aligned.
3. Install Windows on the template VM.
4. Disable NTFS last access.
5. Change disk timeout value.
6. Install all necessary applications and modify any additional system settings.
7. Power off VM and mark as template.

DEPLOY SPACE-EFFICIENT CLONES WITH THE VSC 2.0

This step involves using the NetApp VSC 2.0 provisioning and cloning capability to deploy virtual machines from the template VM. This step assumes that the NetApp VSC has already been installed and configured on a server. The detailed steps involved are as follows:

1. Create a customization specification within VMware vCenter client.
2. Use the NetApp VSC to create the NetApp volumes, attach the datastores, provision the virtual machines, and import into VMware View 4.5.

11.2 DETAILS OF DEPLOYING NETAPP SPACE-EFFICIENT CLONES

PROVISION NETAPP STORAGE

The first step in the VMware View mass deployment process is to provision NetApp storage. Figure 21 shows the complete process.

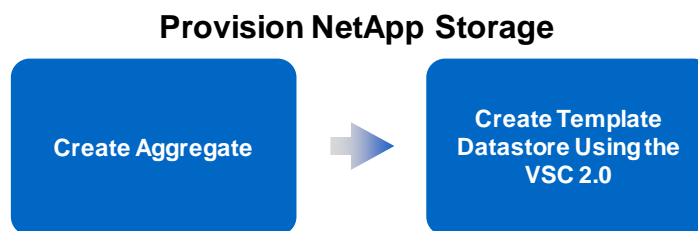

Figure 21) Provision NetApp storage.

CREATE AGGREGATE

Create aggregate(s) on the storage system as per the design. The details on storage design considerations are discussed in chapter 9. Basic recommendations include use RAID-DP and configure fewer, larger aggregates but make sure to follow the storage design. This process can be accomplished very simply using the NetApp System Manager Create Aggregate wizard.

CREATE TEMPLATE DATASTORE USING THE VSC 2.0

As per the storage design, create at least one template datastore on one of the storage controllers. This datastore will be used to house the template VM(s). This process can be accomplished by using the NetApp VSC 2.0. For manual configurations follow the configuration recommendations mentioned in [TR-3749: NetApp and VMware vSphere Storage Best Practices](#), specifically for thin-provisioning, automatic Snapshot copies, volume auto grow, Snapshot auto delete, other generic volume settings (for example, no_atime_update), qtree security style, and so on. If a template datastore already exists within the environment, verify the volume has the proper settings.

1. Log into vCenter using the vCenter client.



2. Either select the Provision datastore icon  from the vCenter taskbar or right-click the data center, cluster, or host to provision a new datastore.

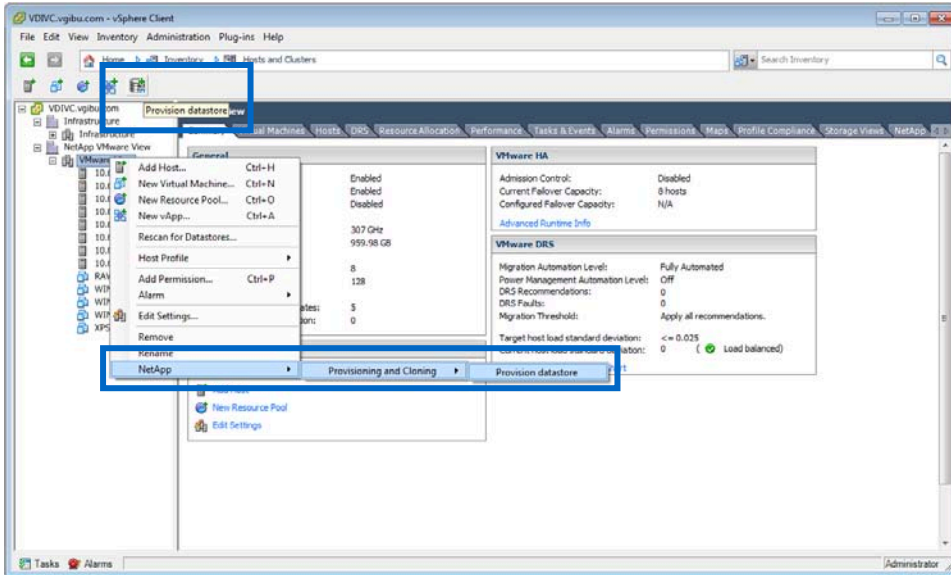

3. Next, select the storage controller on which you want to create the template datastore.

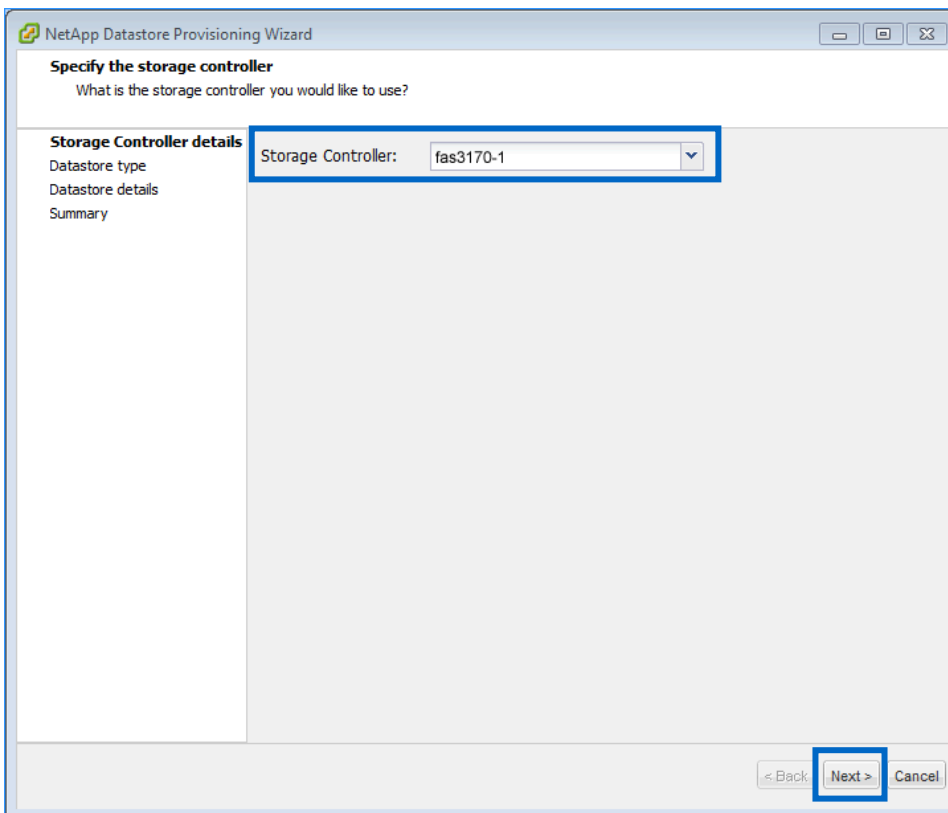

4. Continue with the steps in the following table depending on whether you are using NFS or VMFS.

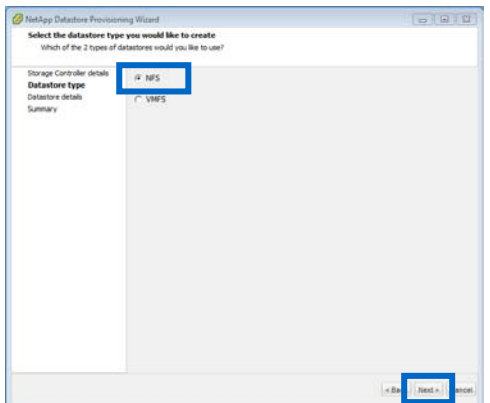
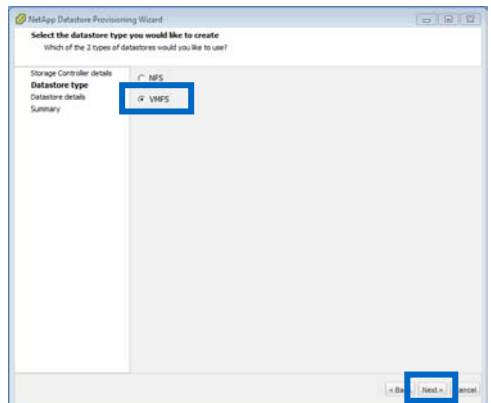
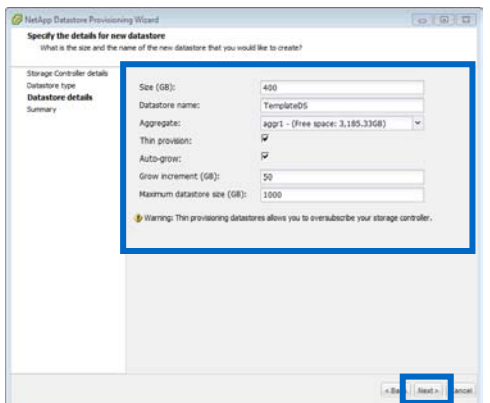
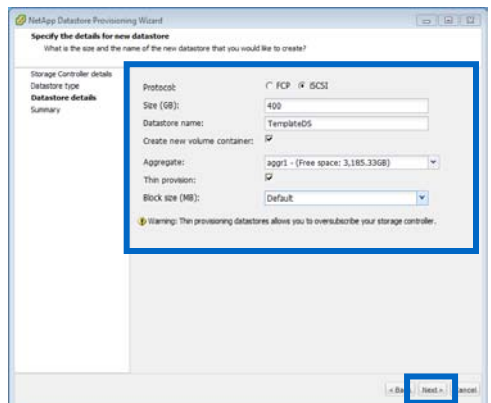
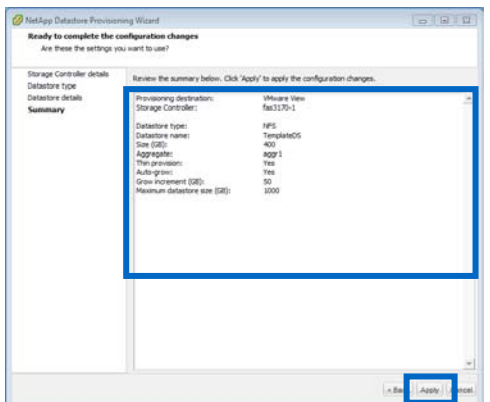
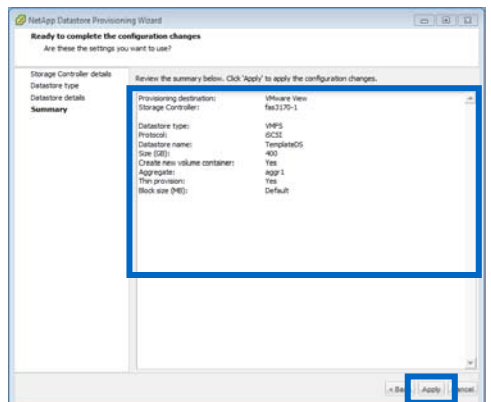
<p>For NFS:</p>	<p>For VMFS:</p>																																								
<p>Select NFS and click Next.</p> 	<p>Select VMFS for iSCSI or FC and click Next.</p> 																																								
<p>Enter in the datastore size and the datastore name; select the aggregate; if applicable, select thin provisioning; set the auto-grow policy; and click Next.</p> 	<p>Enter in the datastore size and the datastore name; choose to create a new volume; select the aggregate; if applicable, select thin provisioning; choose the block size and click Next.</p> 																																								
<p>Review the configuration and click Apply.</p>  <table border="1" data-bbox="341 1428 698 1554"> <tr><td>Provisioning destination:</td><td>VMware View</td></tr> <tr><td>Storage Controller:</td><td>fs3170-1</td></tr> <tr><td>Datastore type:</td><td>NFS</td></tr> <tr><td>Datastore name:</td><td>Template05</td></tr> <tr><td>Size (GB):</td><td>400</td></tr> <tr><td>Aggregate:</td><td>agg1</td></tr> <tr><td>Thin provision:</td><td>Yes</td></tr> <tr><td>Auto-grow:</td><td>Yes</td></tr> <tr><td>Grow increment (GB):</td><td>50</td></tr> <tr><td>Maximum datastore size (GB):</td><td>1000</td></tr> </table>	Provisioning destination:	VMware View	Storage Controller:	fs3170-1	Datastore type:	NFS	Datastore name:	Template05	Size (GB):	400	Aggregate:	agg1	Thin provision:	Yes	Auto-grow:	Yes	Grow increment (GB):	50	Maximum datastore size (GB):	1000	<p>Review the configuration and click Apply.</p>  <table border="1" data-bbox="958 1428 1315 1554"> <tr><td>Provisioning destination:</td><td>VMware View</td></tr> <tr><td>Storage Controller:</td><td>fs3170-1</td></tr> <tr><td>Datastore type:</td><td>VMFS</td></tr> <tr><td>Protocol:</td><td>iSCSI</td></tr> <tr><td>Datastore name:</td><td>Template05</td></tr> <tr><td>Size (GB):</td><td>400</td></tr> <tr><td>Create new volume container:</td><td>Yes</td></tr> <tr><td>Aggregate:</td><td>agg1</td></tr> <tr><td>Thin provision:</td><td>Yes</td></tr> <tr><td>Block size (MB):</td><td>Default</td></tr> </table>	Provisioning destination:	VMware View	Storage Controller:	fs3170-1	Datastore type:	VMFS	Protocol:	iSCSI	Datastore name:	Template05	Size (GB):	400	Create new volume container:	Yes	Aggregate:	agg1	Thin provision:	Yes	Block size (MB):	Default
Provisioning destination:	VMware View																																								
Storage Controller:	fs3170-1																																								
Datastore type:	NFS																																								
Datastore name:	Template05																																								
Size (GB):	400																																								
Aggregate:	agg1																																								
Thin provision:	Yes																																								
Auto-grow:	Yes																																								
Grow increment (GB):	50																																								
Maximum datastore size (GB):	1000																																								
Provisioning destination:	VMware View																																								
Storage Controller:	fs3170-1																																								
Datastore type:	VMFS																																								
Protocol:	iSCSI																																								
Datastore name:	Template05																																								
Size (GB):	400																																								
Create new volume container:	Yes																																								
Aggregate:	agg1																																								
Thin provision:	Yes																																								
Block size (MB):	Default																																								

BUILD TEMPLATE VIRTUAL MACHINE

In this phase, a VM is created that will be the template image for the virtual desktops that you plan to provision for the end users. This process should be familiar, because it is the same process that VMware administrators follow when

creating virtual server templates. The process includes building a VM, performing the guest partition alignment if using Windows XP, installing the OS, applying patches, installing applications and general system settings, and powering off the VM. This process starts by making sure that the guest OS, required business, and infrastructure applications are installed in the template VM and it is in a condition to be duplicated.

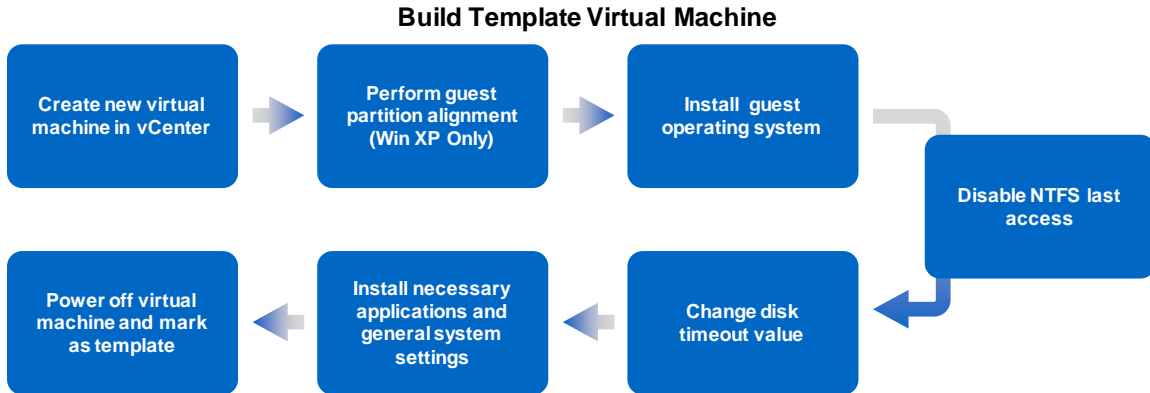

Figure 22) Build template virtual machine.

CREATE NEW VIRTUAL MACHINE IN VCENTER

The first step in the building of a virtual machine is to create a VM within vCenter. Use your company's standard configuration for creating new virtual machines. Make sure to attach all virtual hardware, including networking that will be needed during production. Refer to the VMware recommendations in the Windows XP Deployment Guide at www.vmware.com/files/pdf/XP_guide_vdi.pdf. At the time of this publication, no formal recommendations were available for Windows 7; however, many of the recommendations for Windows XP will still apply.

PERFORM GUEST PARTITION ALIGNMENT

If deploy Windows XP, perform the guest partition alignment for the template VM's VMDK prior to the installation of the guest operating system, as described in [TR-3747: NetApp Best Practices for File System Alignment in Virtual Environments](#).

INSTALL OPERATING SYSTEM

Install Windows XP or Windows 7 on the template VM. For Windows XP desktops, follow VMware recommendations in the Windows XP Deployment Guide at www.vmware.com/files/pdf/XP_guide_vdi.pdf. Install all the baseline applications and service packs. At the time of this publication no formal recommendations were available for Windows 7; however, many of the recommendations for Windows XP will still apply.

DISABLING NTFS LAST ACCESS

It is important to change the value of last access on the template VM, as this will reduce the number of unnecessary I/Os to disk.

1. Log into the template using Remote Desktop or Virtual Center Remote Console.



2. Open a CMD window by going to Start > Run, entering `cmd`, and pressing Enter.

3. Check the current value for disable last access:

```
fsutil behavior query disablelastaccess
```

4. If the value is zero, enter the following to disable last access:

```
fsutil behavior set disablelastaccess 1
```

For more information, visit <http://technet2.microsoft.com/windowsserver/en/library/9fcf44c8-68f4-4204-b403-0282273bc7b31033.msp?mfr=true>.

CHANGE DISK TIMEOUT VALUE

Increasing this value increases the amount of time before a SCSI timeout within the guest OS.

1. Log in to the template using Remote Desktop or Virtual Center Remote Console.



2. Open a regedit by going to Start > Run, typing `regedit` and pressing Enter.
3. Find the TimeOutValue by following the path [HKEY_LOCAL_MACHINE\SYSTEM\CurrentControlSet\Services\Disk].
4. Change the key "TimeOutValue"=dword:00000190.
5. Reboot the VM now or at the end of the installation of applications and general system settings.

INSTALL NECESSARY APPLICATIONS AND GENERAL SYSTEM SETTINGS

Install all the necessary infrastructure and business applications in the template VM. A few examples include Microsoft Office, antivirus software, Adobe Acrobat Reader, and a connection broker agent (if planning to use a connection broker); allow specific users or groups RDP access to the VMs. More settings can be found in the Windows XP Deployment Guide at www.vmware.com/files/pdf/XP_guide_vdi.pdf and on the Web.

POWER OFF VM AND CONVERT TO TEMPLATE (OPTIONAL)

After performing all the template customizations and software installations, power off the virtual machine, as it will need to be powered off to deploy. Then convert the VM to be a template. This reduces the risk of accidentally powering on the VM.

DEPLOY SPACE-EFFICIENT CLONES WITH VSC 2.0

This section describes in detail the use of the VSC 2.0 provisioning and cloning capability to clone one to thousands of virtual machines. The VSC 2.0 is a VMware vCenter plug-in framework that allows VMware administrators the ability to provision virtual machines directly from vCenter without having to leave the vCenter client.

This section assumes that the NetApp VSC has been installed and registered as outlined in chapter 10. For further details, consult the VSC 2.0 Installation and Administration Guide.

The following are the detailed steps involved in the process.

Deploy Space Efficient Clones with VSC 2.0

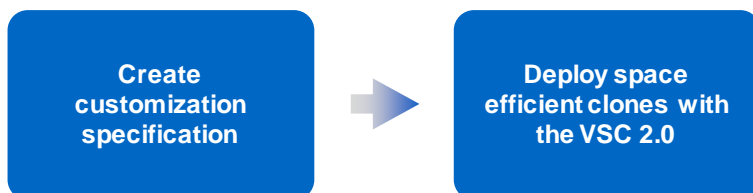

Figure 23) Deploy space-efficient clones with VSC 2.0.

CREATE CUSTOMIZATION SPECIFICATION

Create a customization specification for use with the deployment of the VMs. The customization specification creates the information necessary for sysprep to successfully customize a guest OS from vCenter. It includes information on hostname, network configuration, license information, domain membership, and other information necessary to customize a guest OS. This procedure can be found in the [vSphere Virtual Machine Administration Guide](#) on page 40. This customization specification can be used by VSC Provisioning and Cloning to personalize each VM. In addition to creating the customization specification, sysprep will need to be downloaded and installed if using Windows XP or Windows 2003 as the guest operating system. Procedures to do this can be found in the [vSphere Basic System Administration Guide](#) on page 325.

DEPLOY SPACE-EFFICIENT CLONES USING VSC 2.0

In this example, 2,000 virtual machines will be deployed using VSC. VSC has already been installed on vCenter. It will be used to create eight datastores that have 250 virtual machines each. It will use the following process:

1. Create the clones with file FlexClone.
2. Clone the datastores with volume FlexClone.
3. Mount the datastores to each of the ESX hosts.
4. Create the virtual machines from the cloned vmdk.
5. Customize the virtual machines using the customization specification.
6. Power on the virtual machines.
7. Import virtual machines into VMware View.

To deploy space-efficient clones using VSC 2.0:

1. Log into vCenter using the vCenter client.



2. Once storage controllers have been added, select the inventory button to get back to the servers and VMs. Right-click the VM to be cloned and select "Create Rapid Clones."

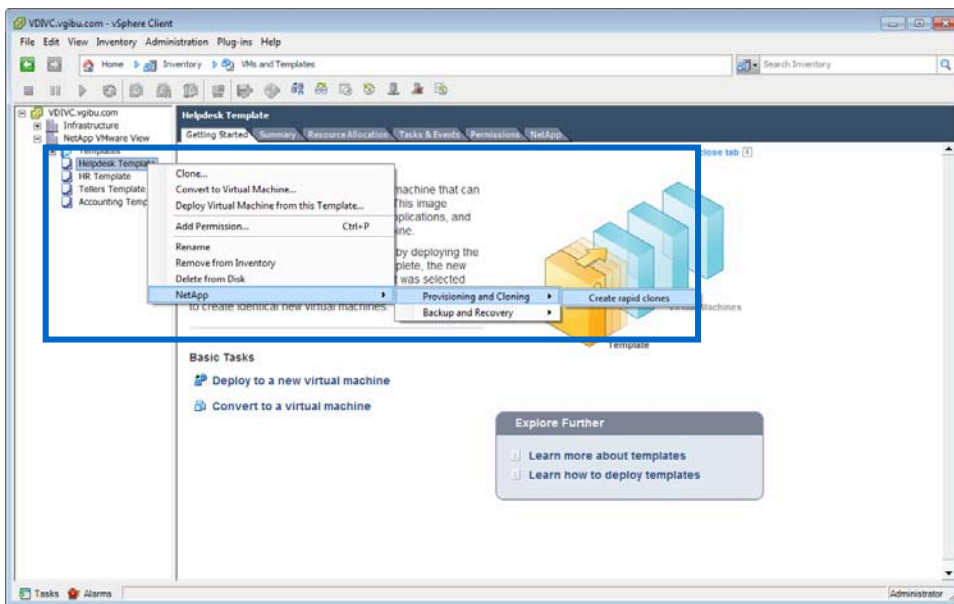

3. Choose the storage controller with the drop-down arrow and click Next.

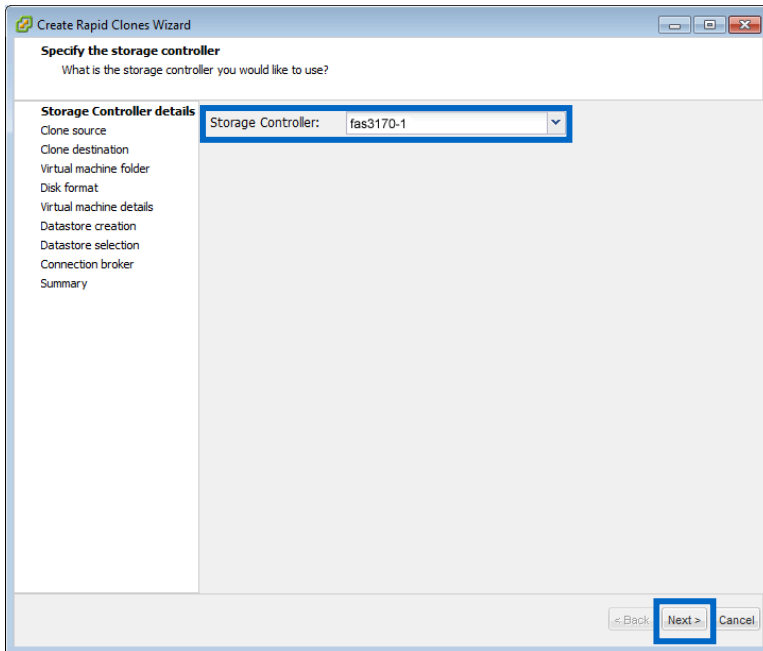

Additionally, if the VMware VI client is not running, select Advanced Options and enter the password for vCenter.

4. Select the data center, cluster, or server to provision the VMs to and select the "Specify the virtual machine folder for the new clones" if necessary and select Next.

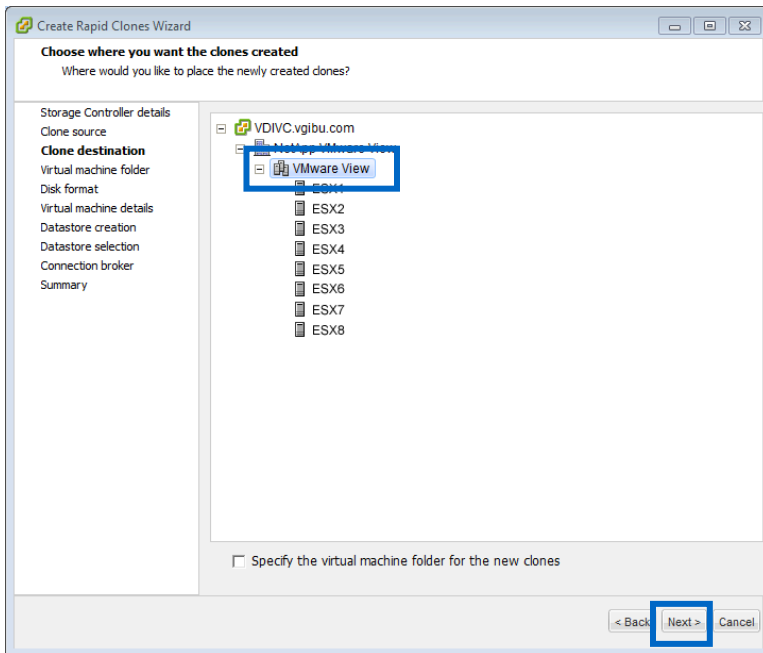

5. Select the disk format you would like to apply to the virtual machine clones and click Next.

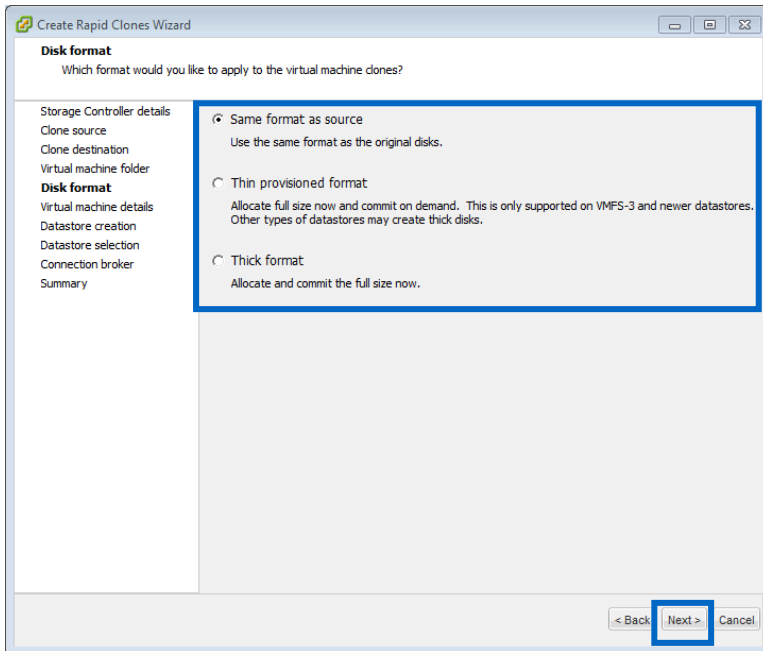

6. Enter in the number of clones, the clone name, the starting clone number, and the clone number increment. Then, if guest customization is required, select the check box and the customization specification that will be applied after the VM has been provisioned. Then choose if the virtual machine will be powered on after the clones are created. Then, if using VMware View, select "Import into connection broker" and choose "VMware View." Then select "Create new datastores if required" and click Next.

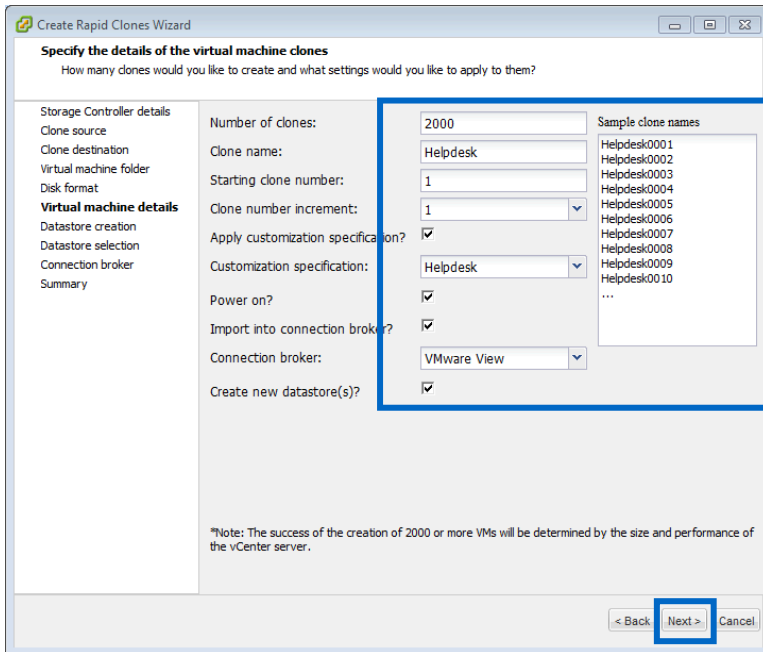

7. If no datastores are present, create select "Create NFS datastore(s)" or "Create VMFS datastore(s)."

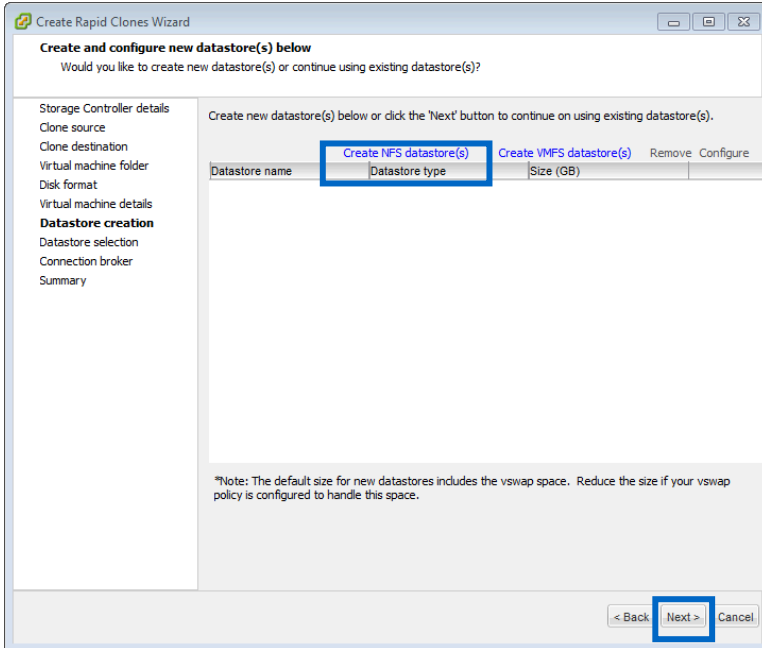

8. Select the number of datastores to create and provide the root of the datastore name, the size of the datastore in gigabytes, and the aggregate that you want to use for the virtual machines. Then check the box for thin provisioning if needed. Then, for NFS-based datastores, the option to autogrow the datastore will appear. Select the grow increment size, maximum size, and specific datastore names and click Next.

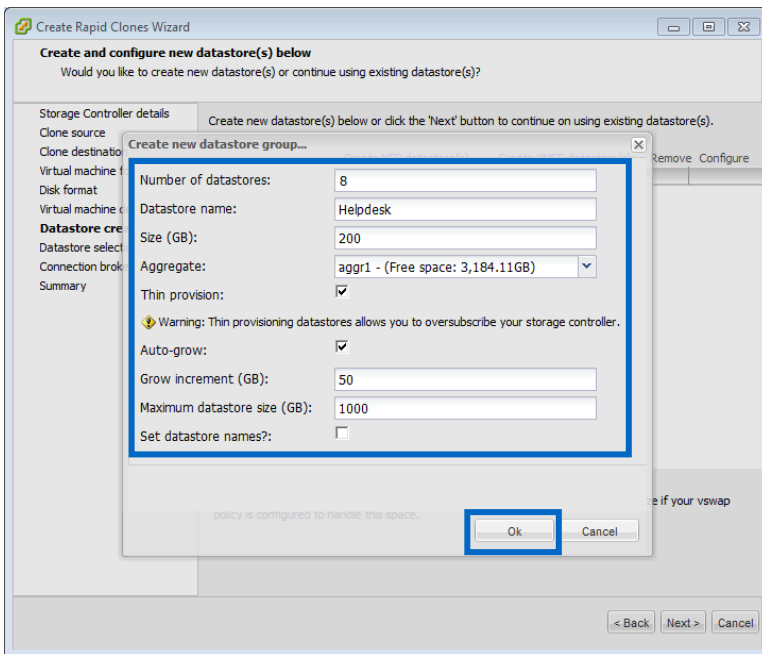

9. After datastore creation, VSC will display the datastore that was created. If necessary, you can create additional datastores at this time, then click Next.

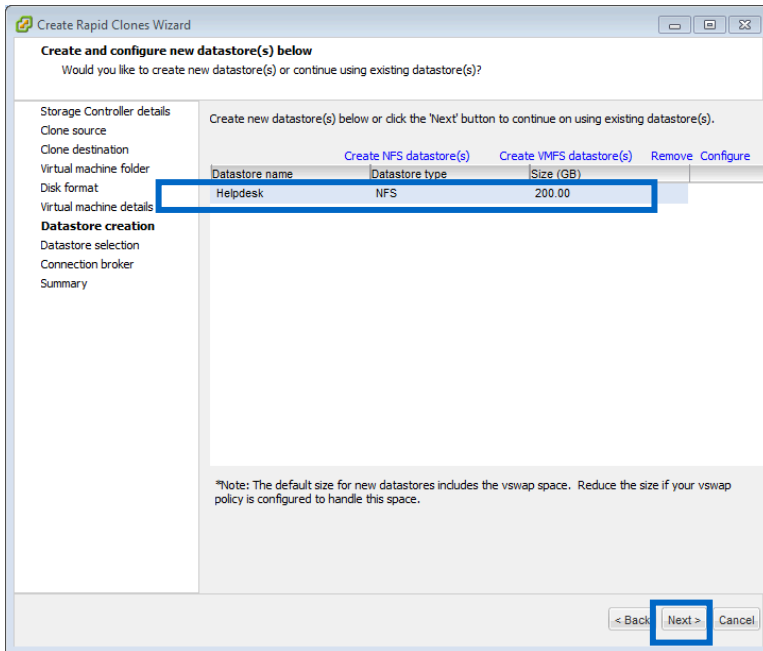

10. Select the datastore where the virtual machine files are to be located and click Next.

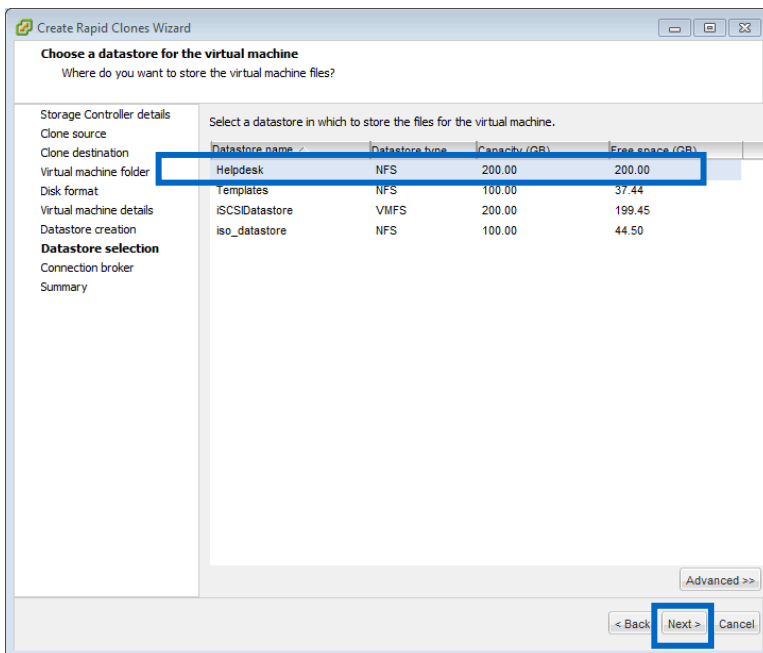

11. If you selected "Import into connection broker," the wizard will ask for the View server hostname, domain name of the View server, user name, and password. Then you can select to create an individual or manual desktop pool and provide a new or existing pool name. For manual pools, the admin has the option to create a persistent or nonpersistent pool. After this has been completed, click Next.

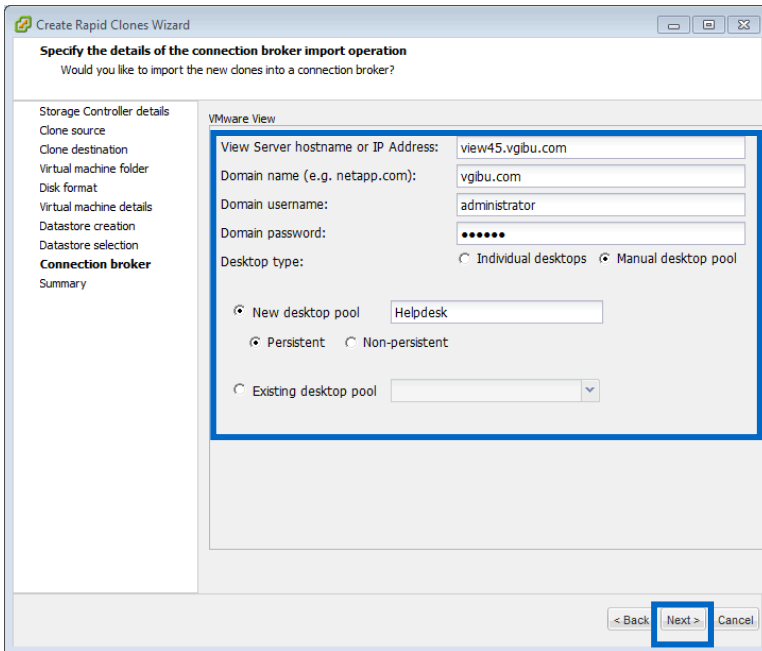

- Review the configuration and, if correct, click Apply. The provisioning process will now begin. You can use the Tasks window within the vCenter client to view the current tasks as well as the NetApp storage controller console.

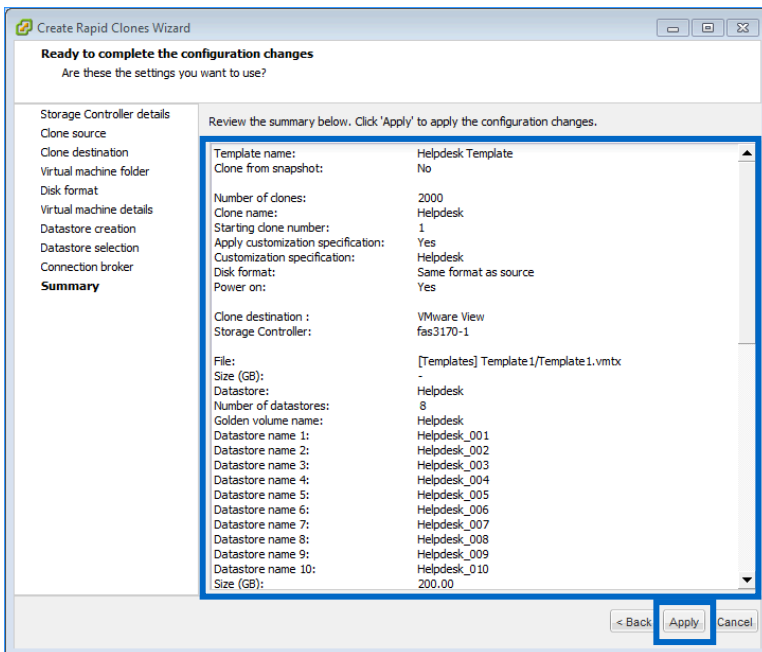

- After the creation of the virtual machines, review the View configuration and entitle users by logging into the VMware View Connection Server 4.5 interface.

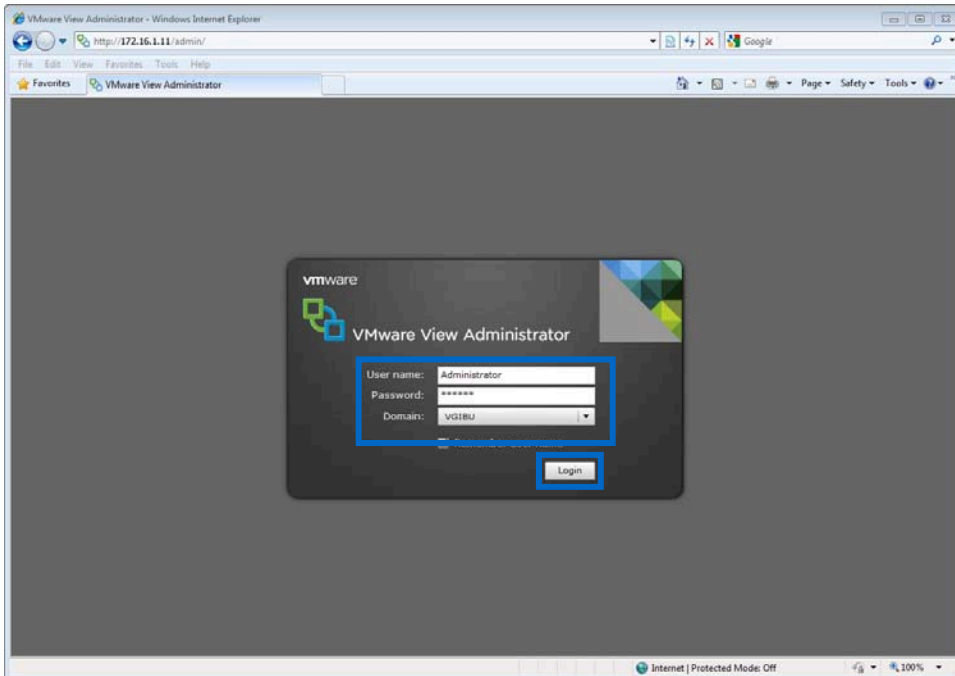

14. Select the pool to be entitled. In this case it is the manual nonpersistent pool Helpdesk and click Entitlements...

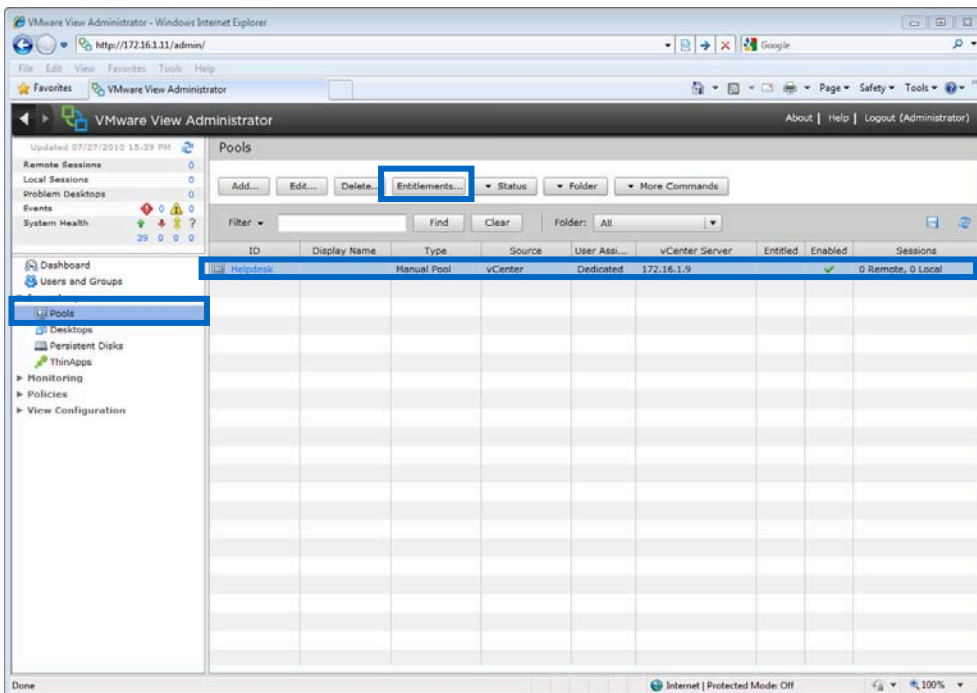

15. On the entitlements screen, click Add.

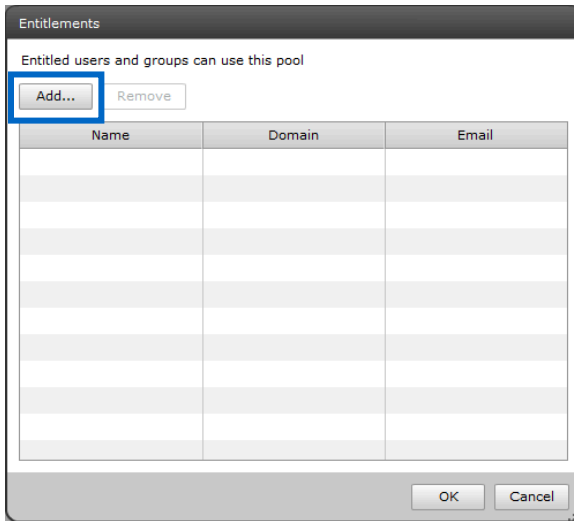

16. Select users or groups, enter either a name or a description to narrow down the search, and click Find. Then click the user(s) or group(s) to be entitled. Then click OK.

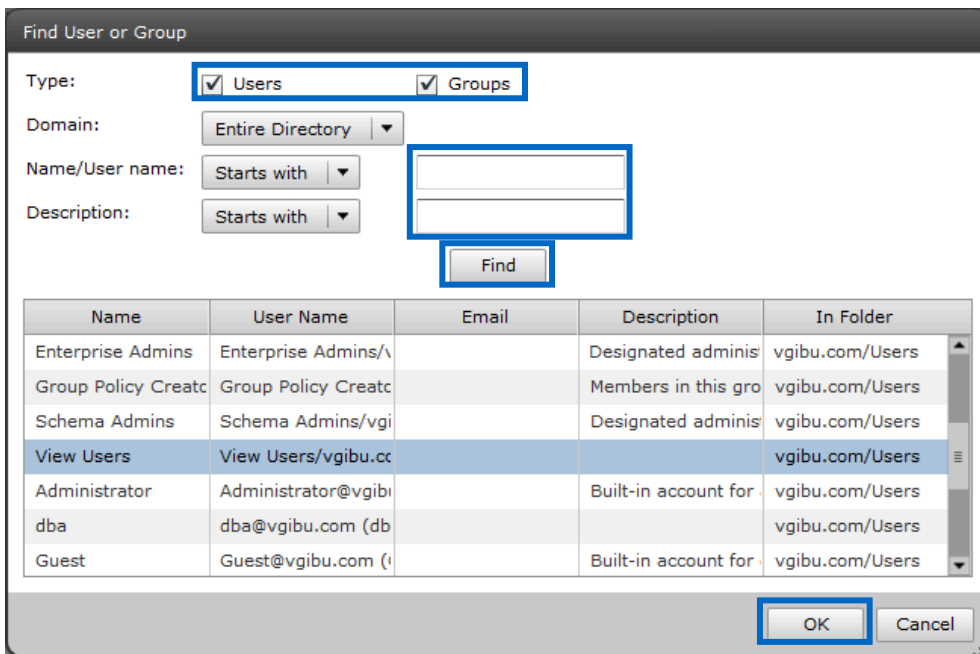

17. Verify that the users and groups to be added are correct and click OK.

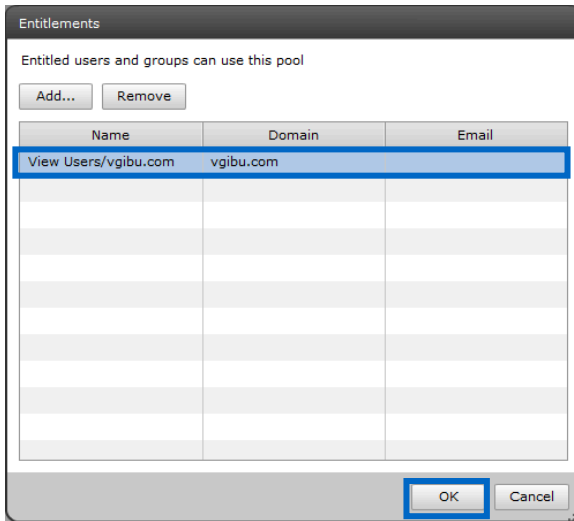

- Verify that the pool is now entitled and enabled.

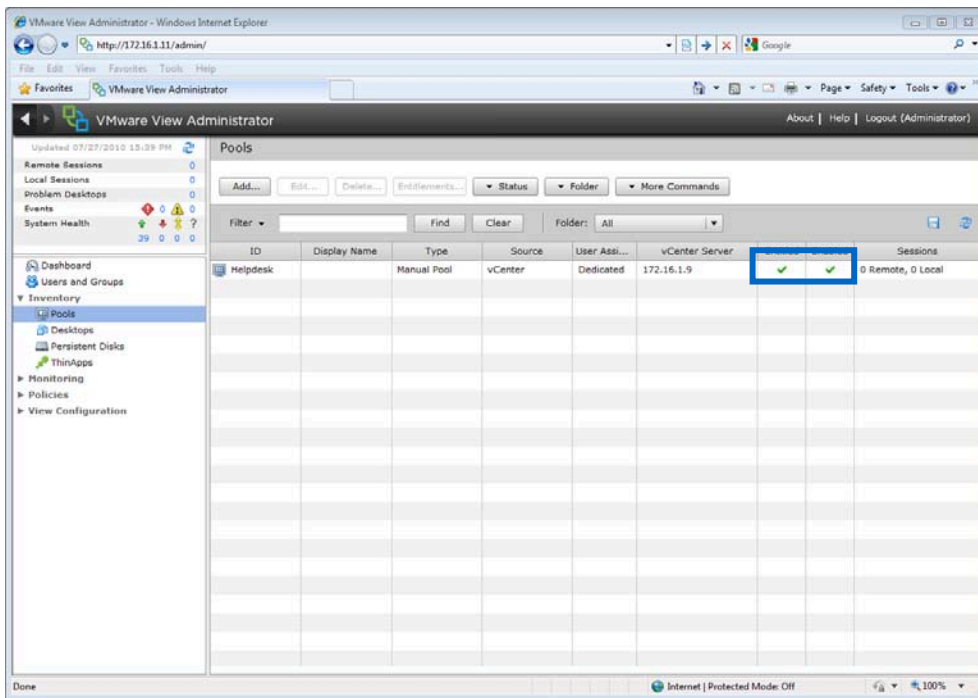

- Adjust the pool settings by clicking the pool, editing, and clicking Next until you get to the desktop/pool settings. Then, after adjusting the pool to your liking, click Finish.

Note: The settings in this example are for demonstration purposes only. Your individual settings might be different. Consult the [View Administration Guide](#) for more information.

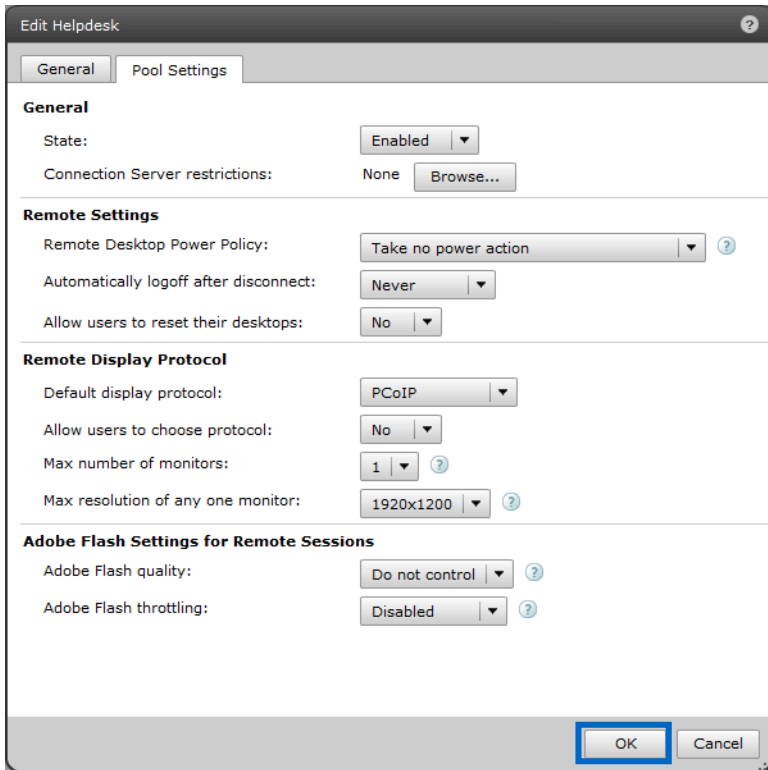

20. Test the connection by logging into a desktop using the View client.

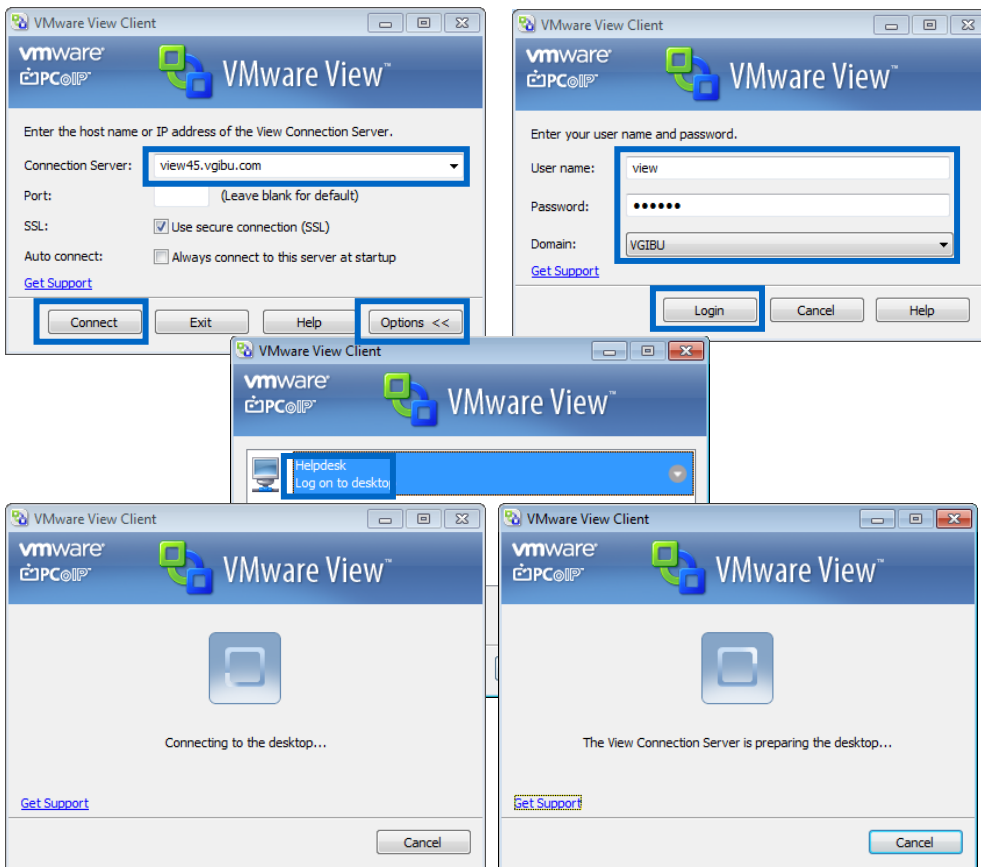

12 USING VSC 2.0 PROVISIONING AND CLONING REDEPLOY

NetApp VSC gives administrators the ability to patch or update template VMs and redeploy virtual machines based off the original template. When desktops or servers are deployed for the first time, VSC will track and maintain the relationship between the desktop and the baseline template. Then, when requested, the administrator can redeploy clones for one or all of the virtual machines that were originally created from the baseline.

The use cases for redeploy include but are not limited to:

- Redeploy after applying Windows patches to the VMs baseline
- Redeploy after upgrading or installing new software to the VMs baseline
- Redeploy when end user calls helpdesk with issues and providing fresh VM would most easily solve user issues

This model of deployment and redeployment works only when end-user data is not stored on a local drive. For this model of redeployment customers should use profile management software (such as AppSense, RTO Software or Liquidware Labs Virtual Profiles) and folder redirection to store user data on CIFS home directories. This way the virtual machine is stateless and stores no user data and can easily be replaced without data loss. In addition, the redeployed image will not contain any end-user installed software, malware, spyware, or viruses, thereby reducing the number of threats to the company.

In Figure 24 four virtual machines were deployed with VSC from the template on the left in the template datastore. After the administrator patched the template, it was then redeployed to the virtual machines (Figure 25) VSC redeploy uses NetApp FlexClone to create near instantaneous clones of the cloned vm1-flat.vmdk file while not disturbing the virtual machine configuration information. This leaves all View entitlements and Active Directory® objects undisturbed.

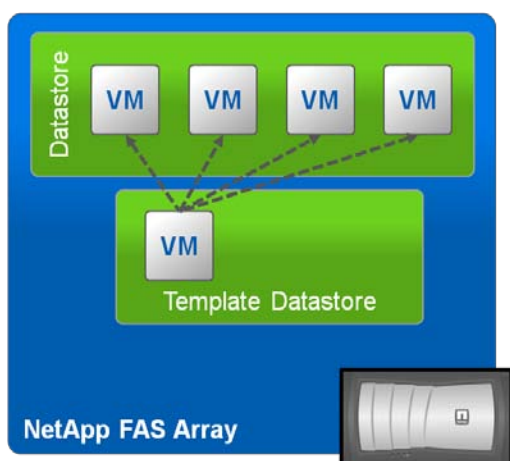

Figure 24) Provision with NetApp VSC 2.0.

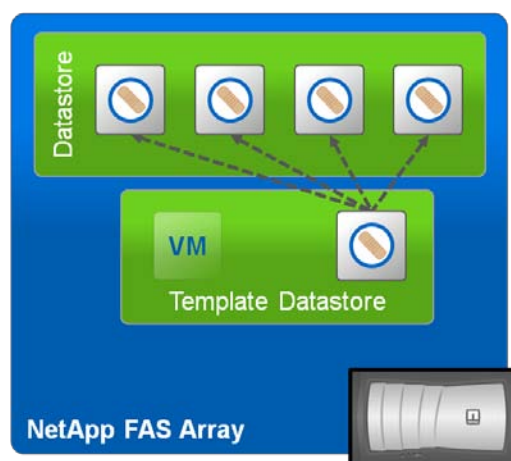

Figure 25) Redeploy patched VMs with VSC 2.0.

Note: Redeploy requires that the vCenter database that was used during the creation of the rapid clones be used to redeploy the clones. If a new vCenter instance or server is installed and a new database is used, the link between the parent baseline and the rapid clones will be broken. If this is the case redeploy will not work. In addition if vCenter is upgraded or reinstalled, VSC 2.0 must be reinstalled as well.

To use VSC redeploy:

1. Install software updates, patches, or changes to the baseline template virtual machine.
2. Log into vCenter using the vCenter client.



3. Select the NetApp icon from the Home screen of the vCenter client.

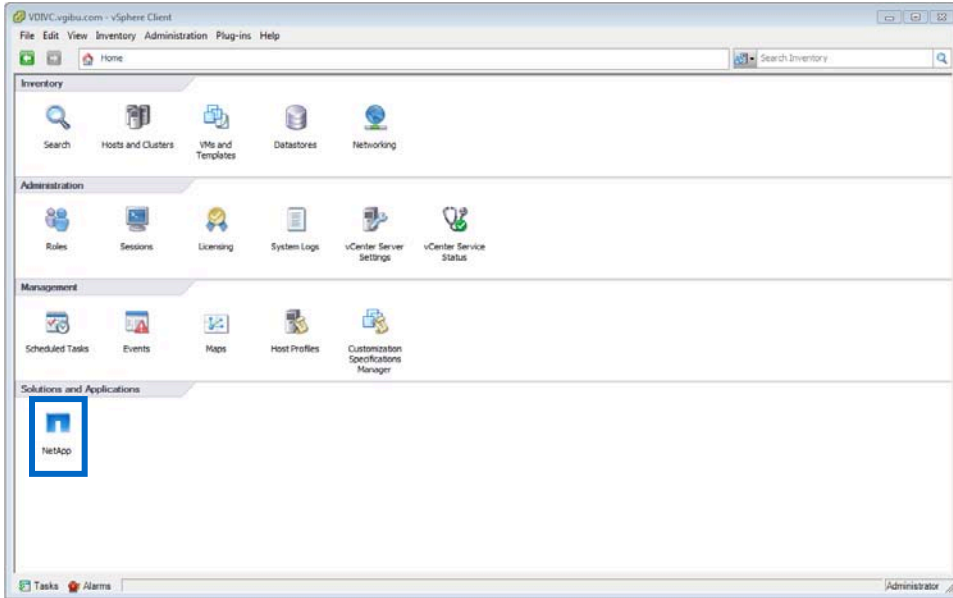

4. Select Redeploy from the provisioning and cloning capability.

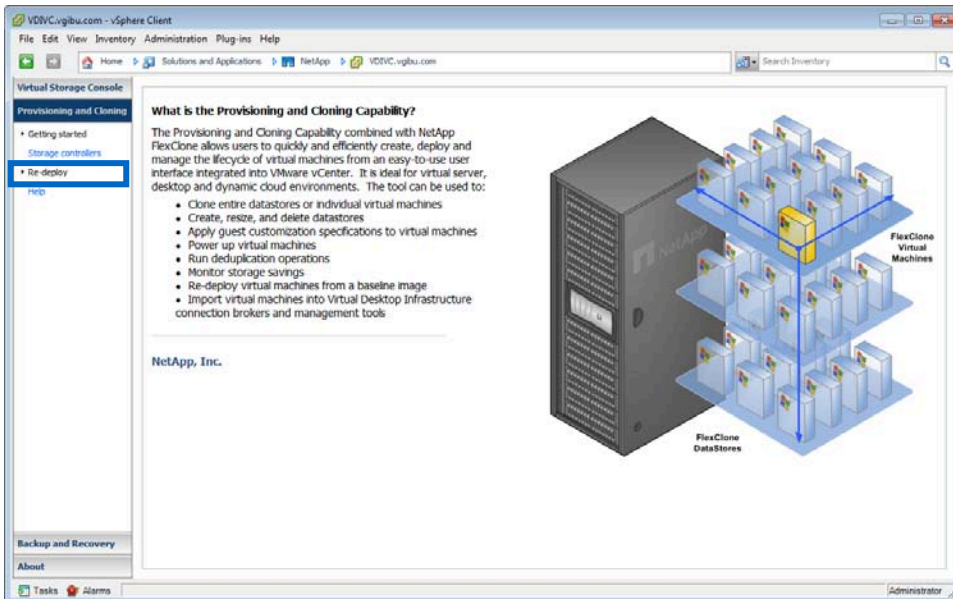

5. Select the baseline from which to redeploy. If the baseline does not appear, click "Update table..." Then select the baseline and click Redeploy...

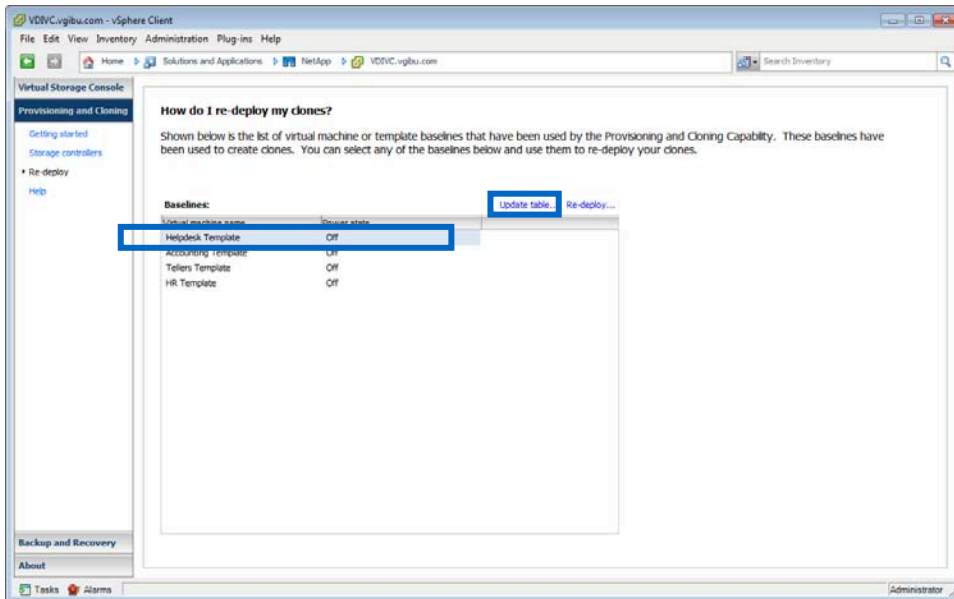

6. Select the some or all of the virtual machines to redeploy and click Next.

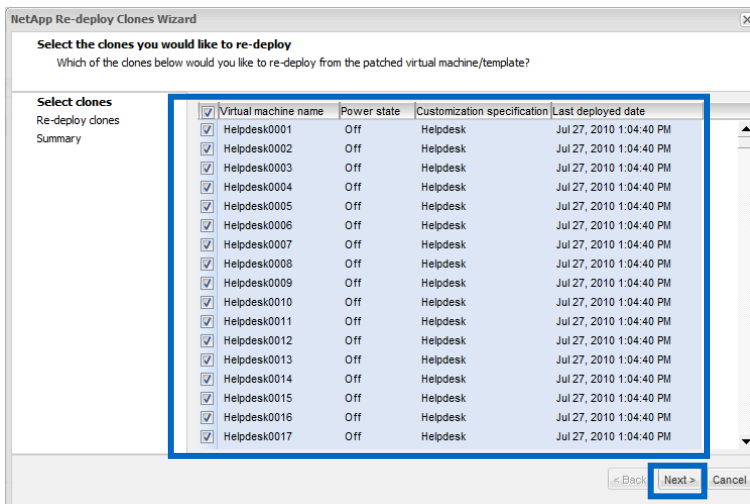

7. If needed, you can choose to power on the virtual machines after the redeploy or apply a new or updated guest customization specification.

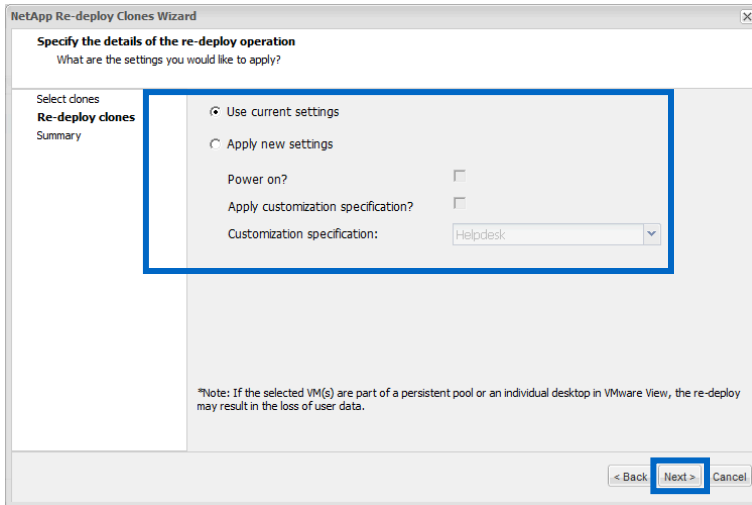

- Review the configuration change summary before proceeding and click Apply to continue.

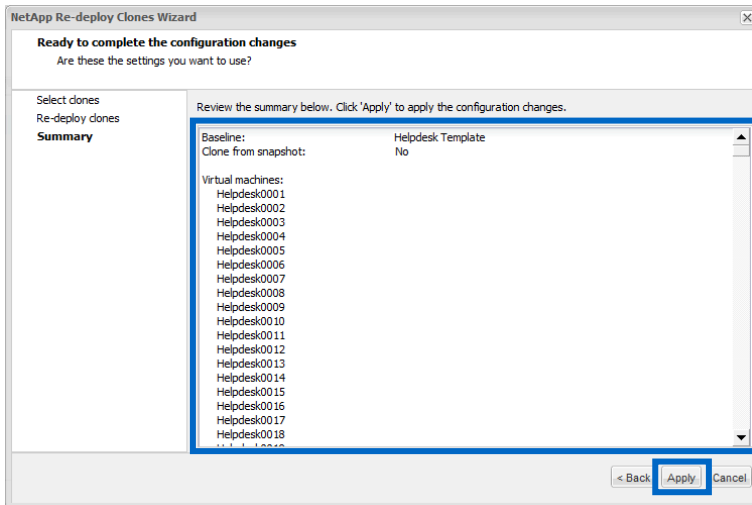

- If the virtual machines are powered on, the VCS redeploy will power off the virtual machines and deploy in groups of 20 virtual machines. If you want to continue, click Yes. If not, click No.

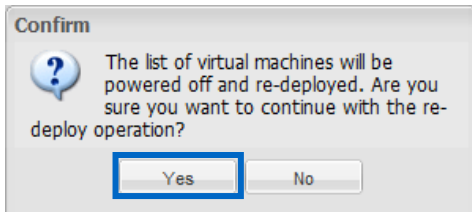

- Watch the tasks bar within Virtual Center to monitor the progress of the redeploy.

13 VMWARE VIEW OPERATIONAL BEST PRACTICES

13.1 DATA DEDUPLICATION

Production VMware View environments can benefit from the cost savings associated with NetApp deduplication, as discussed earlier. Each VM will consume storage as new writes happen. Scheduling and monitoring deduplication operations for the NetApp volumes hosting VMs are very important.

DEDUPLICATION FOR VMS PROVISIONED AS VMWARE FULL CLONES

Using NetApp deduplication, VMs provisioned using VMware full clones or linked clones can also achieve similar storage savings, as seen with the use case of provisioning VMs with NetApp VSC 2.0. Follow these steps to configure deduplication on the datastores hosting these VMs:

1. Log into vCenter using the vCenter client.



2. Select the datastore from either the Datastore tab or within the ESX server, then right-click the datastore and select NetApp > Provisioning and Cloning > Deduplication management...

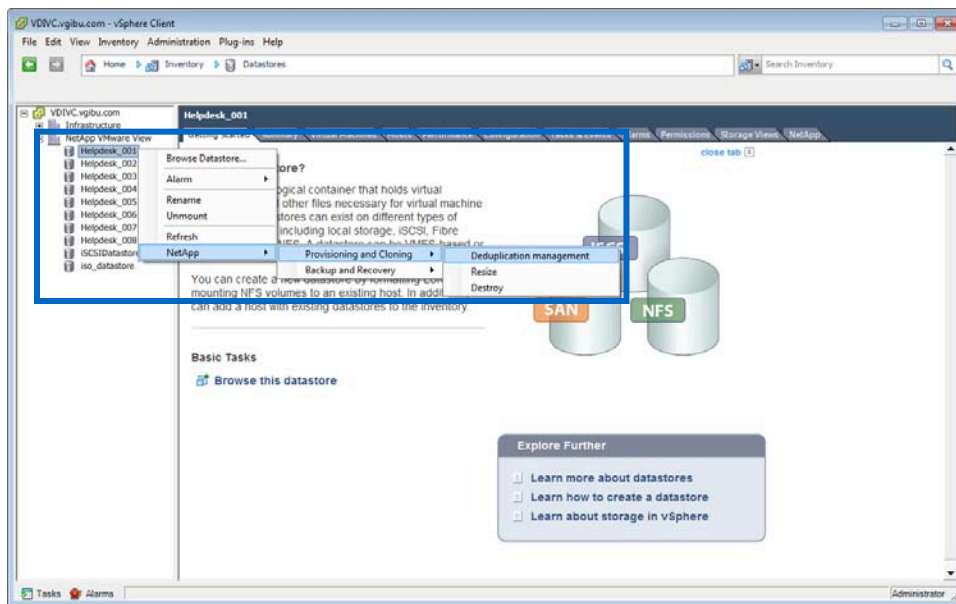

3. Verify the datastore that is to be deduplicated. Then select "Enable deduplication," "Start deduplication," and "Scan" and click OK.

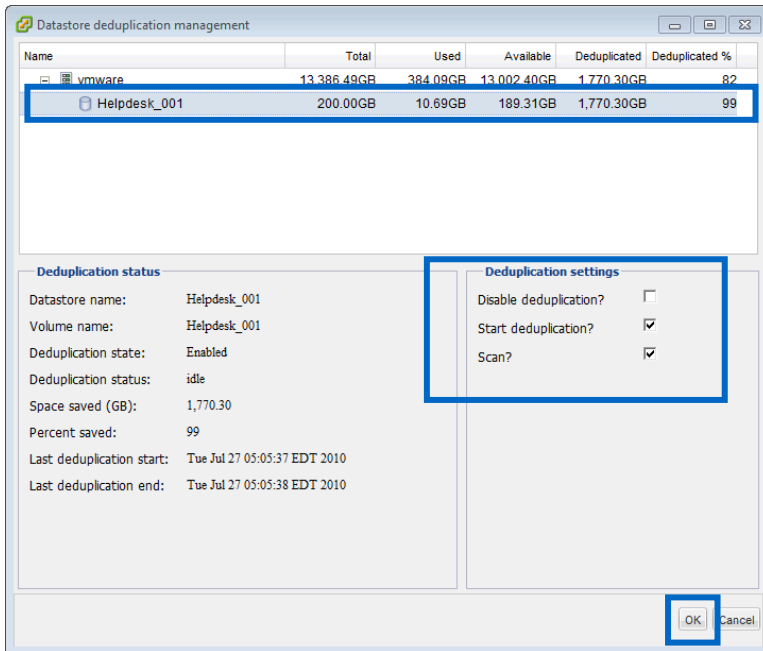

4. If you are using NetApp clones, then deduplication will already be enabled. You can manually start deduplication on all new data or all existing data by checking "Start deduplication" or "Scan?" Start deduplicating all new data from this point forward. Scanning starts a deduplication job of all existing data within the volume.

CONFIGURING DEDUPLICATION SCHEDULES

It is important to schedule the deduplication operations to run during off peak hours so that there is no effect on the end-user experience. Also, it is important to understand the number of simultaneous dedupe operations that can be performed on the storage controller. Planning for dedupe operations will ultimately depend on your environment. Multiple scheduling options are available:

- Specific days of the week and hours, for example, run every day from Sunday to Friday at 11 p.m.
- Automatic: This means that deduplication is triggered by the amount of new data written to the flexible volume, specifically when there are 20% new fingerprints in the change log.
- Specific hour ranges on specific day(s)

To configure deduplication schedules using Systems Manager:

1. Launch the NetApp System Manager.



2. Select the storage controller > Storage, Volumes, right-click the volume to be scheduled, then click Edit.

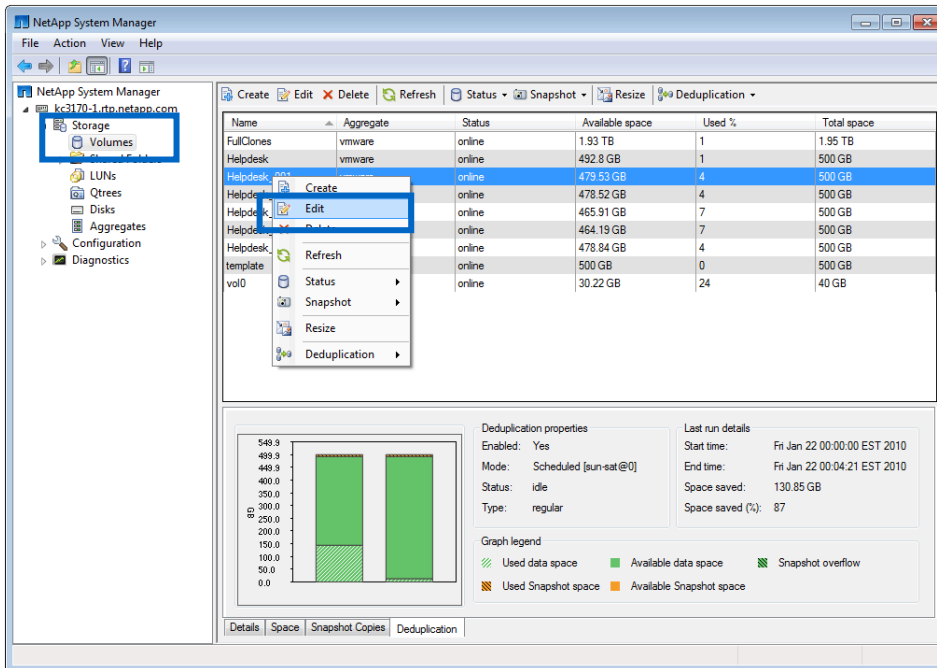

3. Change the custom schedule to run at the times or during the ranges desired and click Apply when completed.

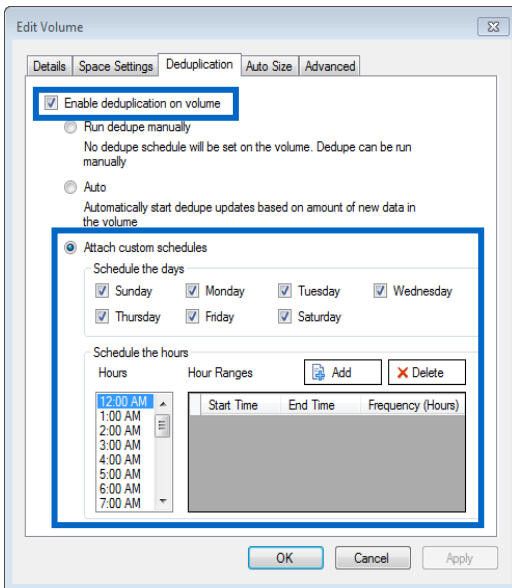

MONITORING DEDUPLICATION OPERATIONS

Deduplication operations should be monitored carefully, as readjusting the schedules for multiple reasons as the environment scales might be required. For example, the deduplication schedule for a new volume (storage controller on the East Coast) hosting a datastore representing a set of users on the West Coast starts too early to be running during production hours.

Pooling virtual desktops with similar characteristics on the same datastore(s) will make it easier to manage dedupe schedules. The status and storage savings of dedupe operations can be monitored using the NetApp System Manager, VSC Deduplication Management tab, and Virtual Storage Console.

For further details on NetApp deduplication, refer to [NetApp TR-3505: NetApp Deduplication for FAS, Deployment and Implementation Guide](#).

13.2 ANTIVIRUS OPERATIONS

For antivirus operations, you could either take a performance hit during scheduled AV operations and affect the end-user experience or appropriately design the VMware View solution to make the AV operations seamless. The first option is definitely not desirable. The second option can be approached in two different ways:

- Optimize the AV operation policies for VMware View. Since VMware View involves moving from a completely distributed CPU (on the end-user desktops) to centralizing much of the processing (in the VMs), the overall AV model should be thought about in a different way. Optimizing the traditional AV policies means better planning the scheduled AV scan and virus definition update so that not all the virtual desktops run AV scan or virus definition updates at the same time, creating CPU contention within the environment. By staggering the scheduled AV operations and distributing the load at different points in time, you can avoid a large percentage of this contention. In addition to modifying the schedules, it is important to verify that these schedules do not interfere with other scheduled events such as backup or replication. In addition, we suggest that AV scanning of CIFS home directories should be done on the storage side, where the storage arrays and AV servers can dedicate processing to this activity. This will take some load off the virtual desktops. For more details, read TR-3107: NetApp Antivirus Scanning Best Practices Guide.
- Select intelligent, optimized, low-cost components for the VMware View solution that can effectively deal with the bursty performance requirement (such as AV operations) without increasing the overall cost of the solution.

Optimizing the AV operations for thousands of virtual desktops is not straightforward and requires even more intelligence, especially from the back-end shared storage. NetApp transparent storage cache sharing and deduplication add a lot of value. They not only significantly reduce the storage requirements for the otherwise redundant VMware View data, but also provide the capability to effectively deal with bursty AV operations, without increasing the overall costs. For more information, visit www.vmware.com/files/pdf/VMware-View-AntiVirusDeployment-WP-en.pdf

13.3 MONITORING NETAPP AND VMWARE VIEW INFRASTRUCTURE

NETAPP OPERATIONS MANAGER

As discussed earlier, NetApp Operations Manager is a comprehensive monitoring and management solution for the VMware View storage infrastructure. It provides comprehensive reports of system utilization and trends for capacity planning, space usage, and so on. It also monitors system performance and health to resolve potential problems. For further details on Operations Manager, visit the following solutions page: www.netapp.com/us/products/management-software/operations-manager.html.

NETAPP ESUPPORT

NetApp's proactive eSupport suite provides an early warning system that can actually reduce the number and severity of technical support cases. Automation tools identify issues early, before they have an effect, and can initiate a fix without customer burden, before people even know there's a potential problem. Support automation works 24x7 to benchmark system status, collect diagnostic information behind the scenes, and issue proactive alerts. You can view the full scope of your NetApp environment on demand, at the company or device level.

NetApp's eSupport suite of support automation tools includes:

- NetApp Remote Support Diagnostics Tool
- NetApp Premium AutoSupport
- NetApp AutoSupport

For more information on NetApp eSupport, visit www.netapp.com/us/support/esupport.html.

SANSCREEN VM INSIGHT

As discussed earlier, consider implementing NetApp SANscreen VM Insight. It provides cross-domain visibility from the VM to the shared storage, allowing both storage and server administration teams to more easily manage their VMware View storage and server architectures. For further details on SANscreen VM Insight, visit the following solutions page: www.netapp.com/us/products/management-software/sanscreen/sanscreen-vm-insight.html.

13.4 DATA PROTECTION SOLUTION

NETAPP VSC 2.0 BACKUP AND RECOVERY (FORMERLY SMVI)

As discussed earlier, NetApp VSC 2.0 Backup and Recovery is a unique, scalable, integrated data protection solution and is an excellent choice for protecting VMware View environments. It integrates VMware snapshots with the NetApp array-based block-level Snapshot copies to provide consistent backups for the virtual desktops. It is NetApp primary storage data deduplication aware and also integrates with NetApp SnapMirror replication technology, which preserves the storage savings across the source and destination storage arrays. You do not need to rerun dedupe on the destination storage array. The Backup and Recovery plug-in also provides a user-friendly GUI that can be used to manage the data protection schemes. The following are some of the important benefits of VSC Backup and Recovery:

- VSC Backup and Recovery Snapshot backups are based on the number of 4KB blocks changed since the last backup, as compared to the number of files changed in a traditional backup solutions (which for virtual desktops can be several gigabytes in size). This means that significantly fewer resources are required and the backups can be completed well within the window. Also, since VSC Backup and Recovery is a storage block-based data protection solution, daily full backups of vmdk files are not required, resulting in a lower TCO.
- Backup failure rate has always been a concern with traditional, server-based backup solutions because of various moving parts in the solution: for example, backup server farms, CPU and memory limitation per server, network bandwidth, backup agents, and so on. With a NetApp solution, the number of moving parts is significantly less and requires very few policies to manage the backups for thousands of virtual desktops as multiple datastores can be part of the same protection policy, also resulting in higher success rate and not introducing new operational complexities.
- There will be significantly less net-new investment for backup infrastructure as VSC Backup and Recovery leverages the inherent capabilities in the NetApp storage array to perform backups and does not require new backup server farms.
- VSC Backup and Recovery allows flexible Snapshot retention scheduling that can be hourly, daily, and weekly to allow you to meet your level of RTO and RPO objectives.
- With VSC Backup and Recovery, there are no concerns about the growth or existence of the vmdk delta files while the hot VM backups are being performed because VSC Backup and Recovery does not require the existence of the vmdk delta files for the entire duration of backups. They have to exist only as part of the preprocessing step before VSC Backup and Recovery invokes the NetApp Snapshot copy on the storage array, which can be a few seconds to a few minutes. Also, you have an option to configure only the NetApp Snapshot copies and ignore performing VMware snapshots.
- Also, since the backups are storage array based and only deduplicated data gets transferred from the primary storage array to the secondary array, there are significantly less storage requirements on the secondary storage array. Also, the resource utilization on the various solution components (servers, storage, network, and so on) will be significantly less.

Scheduling considerations: Running of data protection policies should be properly planned to make sure that they don't interfere with the deduplication operations. Backup jobs should be scheduled to run after the deduplication operations so that minimum possible data has to be replicated.

VMware View considerations: As discussed earlier, a NetApp data protection solution can be leveraged for all seven virtual desktop types. An excellent use case is the data protection for "user data disk," where the user data is encapsulated in a vmdk file. Protecting this data using traditional methods requires performing full backups of vmdk files every day or every time when the policy is scheduled to run. Another important consideration for user data change rate is the delta associated with the "rebalance" operations performed on user data disks.

14 SUMMARY

VMware View enables organizations to increase corporate IT control, manageability, and flexibility without increasing cost and providing end users with a familiar desktop experience. NetApp's key value proposition of at least 50% savings in storage, power, and cooling requirements; performance acceleration; operational agility; and a best-in-class data protection and business continuance solution makes it a perfect choice as a solution for storage and data management for VMware View. The key NetApp technologies (RAID-DP, thin provisioning, FlexClone, deduplication, Snapshot copies, and SnapMirror) provide the foundational strengths to support these claims.

This guide has provided detailed guidance on how to architect, implement, and manage a large, scalable VMware View solution on NetApp storage. It also provides details on the best integration points for each of the key enabling NetApp technologies and how each of the technology concepts plays a critical role and complements each other to work together as an integrated NetApp solution for VMware View of any scale.

This guide is not intended to be a definitive implementation or solutions guide. Expertise might be required to solve issues with specific deployments. Contact your local NetApp representative and make an appointment to speak with one of our VMware View solutions experts.

NetApp FlexShare provides the capability to achieve performance QoS on a per datastore basis. FlexShare provides up to five priority levels to control workload prioritization during contention of storage resources, making it possible to build a VDI environment with multiple “tiers of storage services” for different user types in the environment. VMs for the users that require the highest performance guarantees can be hosted in the datastores with very high FlexShare priority. For detailed information on FlexShare, please see the [NetApp TR-3459: FlexShare™ Design and Implementation Guide](#).

15 FEEDBACK

Send an e-mail to xdl-vgibutmevmtr@netapp.com with questions or comments concerning this document.

16 REFERENCES

- Total Cost Comparison: IT Decision-Maker Perspectives on EMC and NetApp Storage Solutions in Enterprise Database Environments
www.netapp.com/library/ar/ar1038.pdf
- Wikipedia RAID Definitions and Explanations
http://en.wikipedia.org/wiki/Redundant_array_of_independent_disks
- Introduction to VMware vSphere
www.vmware.com/pdf/vsphere4/r41/vsp_41_intro_vs.pdf
- Fibre Channel SAN Configuration Guide
www.vmware.com/pdf/vsphere4/r41/vsp_41_san_cfg.pdf
- iSCSI SAN Configuration Guide
www.vmware.com/pdf/vsphere4/r41/vsp_41_iscsi_san_cfg.pdf
- VMware View Administration Guide
www.vmware.com/pdf/view401_admin_guide.pdf
- VMware View Manager
www.vmware.com/files/pdf/VMware-View-Manager-4-DS-EN.pdf
- VMware View Composer Deployment Guide
www.vmware.com/files/pdf/View_Composer_wp.pdf
- VMware VMworld Conference Sessions Overview
www.vmworld.com/vmworld/home.jspa
- VMware Recommendations for Aligning VMFS Partitions
www.vmware.com/pdf/esx3_partition_align.pdf
- NetApp TR-3001: A Storage Networking Appliance
<http://media.netapp.com/documents/tr-3001.pdf>
- NetApp TR-3066: Data Protection Strategies for NetApp Storage Systems
http://media.netapp.com/documents/wp_3066.pdf
- NetApp TR-3298: RAID-DP: NetApp Implementation of RAID Double Parity for Data Protection
<http://media.netapp.com/documents/tr-3298.pdf>
- NetApp TR-3347: FlexClone Volumes: A Thorough Introduction
<http://media.netapp.com/documents/tr-3347.pdf>
- NetApp TR-3348: Block Management with Data ONTAP 7G: FlexVol, FlexClone, and Space Guarantees
<http://media.netapp.com/documents/tr-3348.pdf>
- NetApp TR-3446: SnapMirror Best Practices Guide
<http://media.netapp.com/documents/tr-3446.pdf>

- NetApp TR-3459: FlexShare Design and Implementation Guide
<http://media.netapp.com/documents/tr-3459.pdf>
- NetApp TR-3466: Open Systems SnapVault (OSSV) Best Practices Guide
<http://media.netapp.com/documents/tr-3466.pdf>
- NetApp TR-3505: NetApp Deduplication for FAS, Deployment and Implementation Guide
<http://media.netapp.com/documents/tr-3505.pdf>
- NetApp TR-3563: NetApp Thin Provisioning
<http://media.netapp.com/documents/tr-3563.pdf>
- NetApp TR-3671: VMware Site Recovery Manager in a NetApp Environment
<http://media.netapp.com/documents/tr-3671.pdf>
- NetApp TR-3737: SMVI Best Practices
<http://media.netapp.com/documents/tr-3737.pdf>
- NetApp TR-3749: NetApp and VMware vSphere Storage Best Practices
<http://media.netapp.com/documents/tr-3749.pdf>
- NetApp® Virtual Storage Console 2.0 for VMware® vSphere Provisioning and Cloning Administration Guide
<http://now.netapp.com/knowledge/docs/hba/vsc/relvsc20/pdfs/cloning.pdf>

17 ABOUT THE AUTHORS

- **Chris Gebhardt** has been with NetApp since 2004 and is currently a Reference Architect leading NetApp VMware VDI virtualization solutions for NetApp's Virtualization and Enterprise Applications Business Unit. Chris has coauthored the NetApp and VMware VDI Best Practices (TR-3705), VMware View on NetApp Deployment Guide Using NFS (TR-3770), and NetApp FAS2050HA Unified Storage: A Guide to Deploying NetApp FAS2050HA with VMware View. He is a contributor to NetApp's Virtualization Blog (<http://blogs.netapp.com/virtualization>). He is a VMware vExpert, VMware Certified Professional 3 and 4, Brocade Certified Fabric Professional, Brocade Certified SAN Designer, and NetApp Certified Implementation Engineer. Prior to joining the Virtualization Business Unit, he was a Professional Service Consultant with NetApp and was the Central Area Practice Lead for Network Storage Consolidation and Virtualization Practice, where he authored many deployment guides. Prior to joining NetApp, Chris was a UNIX and NetApp administrator for seven years at a worldwide telecommunications company.
- **Abhinav Joshi** is a Reference Architect in the Virtualization and Enterprise Applications Business Unit at NetApp with over nine years of experience around data center consolidation and virtualization. In his current role, he is leading and contributing to the development of end-to-end solution architectures and best practices around VMware View (VDI) and virtualized business apps (for example, SQL Server®, Exchange, SharePoint®). Abhinav has coauthored the NetApp and VMware VDI Best Practices (TR-3705), VMware View on NetApp Deployment Guide Using NFS (TR-3770), NetApp FAS2050HA Unified Storage: A Guide to Deploying NetApp FAS2050HA with VMware View, Microsoft Exchange, SQL Server, and SharePoint on VMware vSphere 4, NetApp, and Cisco (TR-3785), and Best Practices for File System Alignment in Virtual Environments (TR-3747) and contributed to several other white papers. Abhinav is an active contributor to NetApp's Virtualization Blog (<http://blogs.netapp.com/virtualization>). Prior to joining NetApp in early 2008, he served as a lead solutions architect helping customers design and deploy large-scale next-generation data centers. Abhinav is a VMware vExpert, VMware VCP (3 and 4), NetApp NACA and NACP, SNIA-SCP, and EMC Proven Associate (EMCPA).

18 ACKNOWLEDGEMENTS

The authors of this solution guide would like to thank George Costea, Eric Forgette, Peter Learmonth, Jack McLeod, Mike Slisinger, Vaughn Stewart, and Larry Touchette for their contributions to this book.

19 VERSION HISTORY

Version	Date	Document Version History
Version 1.0	September 2008	Original document
Version 2.0	November 2008	Updates to transparent storage cache sharing with NetApp Flash Cache and deduplication
Version 3.0	March 2009	Update for VMware View Manager, transparent storage cache sharing, sizing, operational best practices, and RCU 2.0
Version 3.0.1	May 2009	Updated FlexScale mode recommendation
Version 4.0	February 2010	Updated to include VMware vSphere 4, VMware View 4.0, RCU 3.0, VSC 1.0, and System Manager 1.0
Version 4.0.1	March 2010	Format and link updates
Version 4.5	August 2010	Update to include NetApp VSC 2.0, View 4.5, vSphere 4.1

NetApp provides no representations or warranties regarding the accuracy, reliability or serviceability of any information or recommendations provided in this publication, or with respect to any results that may be obtained by the use of the information or observance of any recommendations provided herein. The information in this document is distributed AS IS, and the use of this information or the implementation of any recommendations or techniques herein is a customer's responsibility and depends on the customer's ability to evaluate and integrate them into the customer's operational environment. This document and the information contained herein may be used solely in connection with the NetApp products discussed in this document.