

Design and Development of Pico-hydro Generation System for Energy Storage Using Consuming Water Distributed to Houses

H. Zainuddin, M. S. Yahaya, J. M. Lazi, M. F. M. Basar and Z. Ibrahim

Abstract—This paper describes the design and development of pico-hydro generation system using consuming water distributed to houses. Water flow in the domestic pipes has kinetic energy that potential to generate electricity for energy storage purposes in addition to the routine activities such as laundry, cook and bathe. The inherent water pressure and flow inside the pipe from utility's main tank that used for those usual activities is also used to rotate small scale hydro turbine to drive a generator for electrical power generation. Hence, this project is conducted to develop a small scale hydro generation system using consuming water distributed to houses as an alternative electrical energy source for residential use.

Keywords—Alternative Energy, Energy storage, Permanent Magnet DC Generator, Pico-Hydro Generation System.

I. INTRODUCTION

THE Pico hydro is hydro power with a maximum electrical output of five kilowatts (5kW). Hydro power systems of this size benefit in terms of cost and simplicity from different approaches in the design, planning and installation than those which are applied to larger hydro power. Recent innovations in pico-hydro technology have made it an economic source of power even in some of the world's poorest and most inaccessible places. It is also a versatile power source. AC electricity can be produced enabling standard electrical appliances to be used. Common examples of devices which can be powered by pico-hydro are light bulbs, radio and televisions.

Normally, pico-hydro power system is found at rural or hilly area [1]-[5]. Figure 1 shows an example of typical pico-hydro system applications at hilly area. This system will operate using upper water reservoir which is a few meter high from ground. From the reservoir, water flows downhill through the piping system. This downhill distance is called "head" and it allows the water to accelerate for prime moving system. Thus, the turbine will rotate the alternator to produce electricity. However, this research is conducted to show the potential of consuming water distributed to houses at town area as an alternative of renewable energy source.

The authors are with Faculty of Electrical Engineering, Universiti Teknikal Malaysia Melaka, Locked Bag No. 1752, Durian Tunggal Post Office, Durian Tunggal, Melaka, Malaysia. (phone: +606-5552344; fax: +606-5552222; email: hidayat@utem.edu.my, sharil@utem.edu.my, jurifa@utem.edu.my, mfarriz@utem.edu.my, zulkfliibrahim@utem.edu.my)

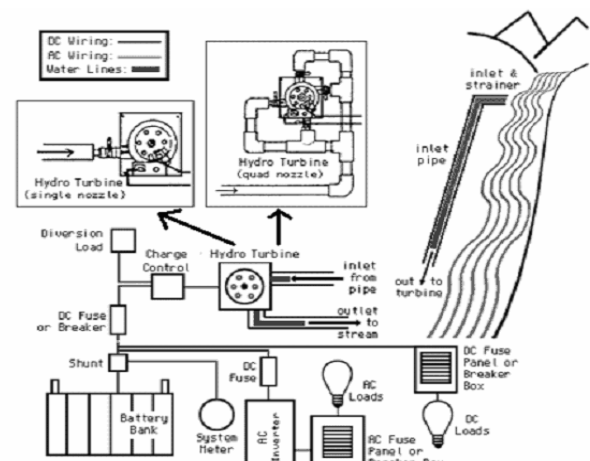

Fig. 1 Example of pico-hydro power system applications at rural area

The water flow inside the pipelines has potential of kinetic energy to spin small scale generator turbine for electricity generation. Therefore, this project has been done to show the additional use of consuming water distributed to houses for electrical power generation instead of routine activities such as bathe, laundry and dish wash. The electricity can be generated at the same time those usual activities are done without extra charge on the water bill consumption. The main function of the system is to store the generated power by means of battery charging for future use particularly during electricity blackouts. The proposed system is expected has a maximum capacity of 10W which is very much less compared to other pico-hydro power systems.

II. PICO-HYDRO SYSTEM PLANNING

This stage is the most critical stage in this research project as it determines the feasibility and achievability of the proposed pico-hydro system. There are many factors that determine the feasibility and achievability of the system. This includes:

- The amount of power available from the water flow inside the pipelines. This depends on the water pressure, amount of water available and friction losses in the pipelines.
- The turbine type and availability of required generator

type and capacity.

- iii. The types and capacity of electrical loads to be supplied by the pico-hydro system.
- iv. The cost of developing the project and operating the system

A. Power Estimation

In general, the feasibility of the proposed pico-hydro system is based on the following potential input and output power equation:

$$P_{in} = H \times Q \times g \quad (1)$$

$$P_{out} = H \times Q \times g \times \eta \quad (2)$$

Where,

- P_{in} = Input power (Hydro power)
- P_{out} = Output power (Generator output)
- H = Head (meter)
- Q = Water flow rate (liter/second)
- g = gravity (9.81 m/s^2)
- η = efficiency

Based on the equation (1) and (2), both head and water flow rate are very important parameters in hydro power system. Head is a measure of falling water at turbine, i.e. vertical distance from the top of the penstock to the turbine at the bottom. Conversely, water flow rate is the amount of water flows within one second. Normally, water flow available is more than needed since the flows for pico-hydro are small [3]. Thus, it is important to measure the head carefully because the greater head, the greater power and the higher speed of the turbine rotation.

Basically, power produced by a hydro power system is converted from one form to another; some is lost at each stage as illustrated in Figure 2. It is noted in the figure that the first stage of loss is the power loss in penstock. For the proposed pico-hydro system, this is referred to the friction loss in the pipelines. Before the losses in the pipelines are taken into account, the drop is referred as the gross head and after losses have been subtracted it is called the net head. In this research project, both equations (1) and (2) have already considered the friction loss, and thus the net head is used.

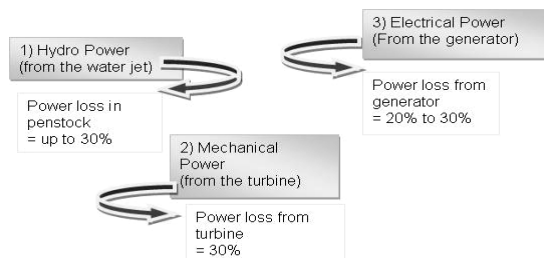

Fig. 2 Power loss during the conversion from hydro power to electricity

For the proposed pico-hydro system, the biggest loss usually occurs when the power in the water pipeline is converted into rotating, mechanical power by hitting the turbine blades, i.e. 30% of the total hydro power going out

from the nozzle. A further 20% to 30% will be lost in the generator when the mechanical power is converted to electricity. Thus, the rule of thumb for efficiency to estimate the potential output power is normally 50% [3].

B. Head Measurement

When determining head (falling water), gross or “static” head and net or “dynamic” head must be considered. Gross head is the vertical distance between the top of the penstock and the point where the water hits the turbine. Net head is gross head minus the pressure or head losses due to friction and turbulence in the penstock. These head losses depend on the type, diameter, and length of the penstock piping, and the number of bends or elbows. Gross head can be used to estimate power availability and determine general feasibility, but net head is used to calculate the actual power available.

There are many methods of head measurement [6]. However, since the proposed Pico-hydro system uses consuming water distributed to houses supplied by the Water Utility Company whereby the utility’s water tank can be very far from the houses, the simplest and most practical method for head measurement is water-filled tube and calibrated pressure gauge. Through this method, the pressure gauge reading in psi can be converted to head in meters using the following equation of pressure to head conversion [6]:

$$H = 0.704 \times P \quad (3)$$

Where,

- H = Head (meter)
- P = Pressure (psi)

Equation (3) shows that the water pressure at consumers’ end is a very important parameter to be determined in the design and development of the proposed pico-hydro system. The water pressure represents the net head of the system that useful to calculate the actual power available.

C. Water Flow Rate Measurement

The most simple of flow measurement for small streams is the bucket method [6]. Therefore, this method has been used due to the capacity of the proposed hydro power system is significantly small. Moreover, this method is considerably practical due to the proposed hydro power system is very uncommon compared to other system in its category in which the source of energy is from the consuming water distributed to houses by the Water Utility Company. Through out this method, the flow rate of the distributed water is diverted into a bucket or barrel and the time it takes for the container to fill is recorded. The volume of the container is known and the flow rate is simply obtained by dividing this volume by the filling time. For example, the flow rate of water that filled 20 liters bucket within one minute is 20 liters per minute or 0.333 l/s. This is repeated several times to give more consistent and accurate measurement.

D. Pipeline System and Friction Loss

Piping system is used to carry water to a turbine. This is commonly termed as penstock which consists of pipe from the

reservoir or forebay tank to the turbine and valve or gate that controls the rate of water flow. The proposed pico-hydro system will have the water source from consuming water distributed to houses. Thus, the system must be designed with ability to produce high water pressure to rotate the turbine at the most possible speed and at the same time the water can be recycled and used to other routine activities such as bathe and laundry. Thus, no extra charge on the water bill consumption incurred. In order to do so, a suitable piping scheme with appropriate nozzle between the source (consumers' end) and the turbine is required to maximize the turbine rotation speed. Figure 3 illustrates the drawing of the proposed pico-hydro piping system.

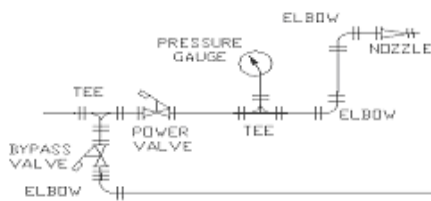

Fig. 3 Proposed pico-hydro piping system

In real fluid flows, friction losses occur due to the resistance of the pipe walls and the fittings. This leads to an irreversible transformation of the flowing fluid energy into heat. Friction head loss is divided into two main categories, "major losses" associated with energy loss per length of pipe, and "minor losses" associated with bends, fittings, valves, etc. For the proposed system, the hydro power available at the consumers' water outlet (consumers' end) is the net power after taking into account the friction losses along the pipelines from the utility tank to the consumers. Thus, consideration on the pipe length and diameter to handle the amount of water flow and piping accessories to convey the water to the turbine is very important to minimize the friction loss for the piping scheme between the source and the turbine of the pico-hydro power system.

This can be done by appropriately select the diameters and types of bends, fittings and valve and minimizing the use of these accessories. Moreover, it is necessary to minimize the piping system length between the water source and the turbine although it is extremely short when compared to the main pipeline from the utility tank to consumers' end. By considering all these matters, the proposed piping pico-hydro piping scheme is assumed to have minor friction losses or can be neglected. This means the net hydro power at consumers' end is more or less similar to hydro power to turbine. As a result, the following are the list of piping accessories that used in the system:

- i. Valve – ball valve
- ii. Nozzle – variable
- iii. Elbow – 90 degree
- iv. Tee – flanged
- v. Straight connector
- vi. Pressure Gauge – 0 to 10 bar

- vii. Main pipe – diameter 1.5mm

E. Selection of Generator

Generating system for a hydro power scheme is selected based on the following concerns:

- i. The estimated power of a hydro power system.
- ii. Type of supply system and electrical load: AC or DC
- iii. Available generating capacity in the market
- iv. Generator with cost effective

Normally, pico-hydro systems use AC generator either induction or synchronous machine type [6]. This is because the system is used to supply AC electrical appliances and DC generator with size above 2kW is said expensive and has brush gear that requires appreciable maintenance [6]. In addition, DC switches for the voltages and currents concerned are more expensive than their AC equivalents.

However, in this project, a brush permanent magnet DC generator is preferred as the main function of the proposed pico-hydro system is for energy storage (battery charging). One significant advantage of using DC type of permanent magnet generator over AC generator is that DC generator is designed to provide high currents at minimum voltage requirement for the charging of battery and operation of direct current loads. This is related with the load type to be supplied. Moreover, permanent magnet generator is selected as it is much cheaper and has smaller overall size rather than of wound field. Other than that, this type of generator is more efficient because no power is wasted to generate the magnetic field.

Hence, permanent magnet DC generator manufactured by "Windstream Power" with maximum power output of 80W at 2800rpm shaft rotation is chosen. The capacity of the generator is considerably high compared to the estimated power mentioned earlier, i.e. 10W. This is because it is very difficult to find the generating capacity available in the market that match with the estimated power. The maximum current at continuous duty is 1.5A whilst maximum current for 10minutes duty is limited to 2.5A. One indisputable problem that will be encountered when using this generator is high torque during the shaft rotation. This makes the rotation of the generator is not at the highest possible speed. Research on the generator design itself to maximize the system efficiency will be done in the future.

F. Selection of Turbine Type

Selection of turbine to be used is very important in the design and development of a hydro power system. Table 1 shows the groups of impulse and reaction turbines that are available [6]. In general, reaction turbine is fully immersed in water and is enclosed in a pressure casing. The runner or rotating element and casing are carefully engineered so that the clearance between them is minimized. In contrast, impulse turbine can operate in air and works with high-speed jet of water. Usually, impulse turbines are cheaper than reaction turbines because no specialist pressure casing and no carefully engineered clearance are needed.

TABLE I
GROUPS OF IMPULSE AND REACTION TURBINE

Turbine Runner	Head pressure		
	High	Medium	Low
Impulse	Pelton Turgo Multi-jet Pelton	Crossflow Turgo Multi-jet Pelton	Crossflow
Reaction		Francis Pump-as-turbine	Propeller Kaplan

Based on its operating principle, impulse turbine is fit with the proposed pico-hydro system as the hydro power is in the jet of water. It has been highlighted that Pelton turbine is commonly used in a small scale hydro power system [6] particularly in pico-hydro system [1]-[3] due to its suitability. One of convenient methods for selecting a turbine for particular hydro system is given in Figure 4 [6]. The turbine type is selected based on the speed range and power capacity of alternator to be used. It can be noticed in the figure that Pelton turbine is a quite universal turbine. It is not always restricted to high head, but if the power transmitted is low, then the Pelton will also run on low heads, although at slow rotational speed. In the proposed pico-hydro power system, a small scale of Pelton turbine is used.

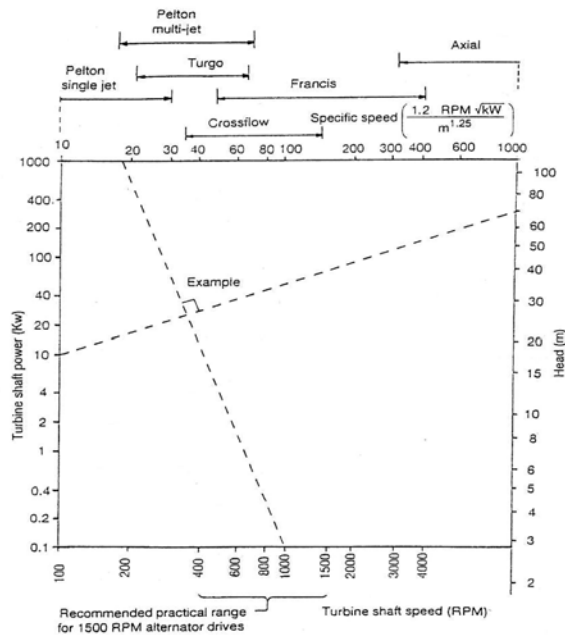

Fig. 4 Nomogram for selection of a turbine for a hydro site

F. Types of Electrical Loads

Electrical loads that are normally connected to a pico-hydro system at rural area are lighting, battery chargers, radios, televisions, ventilation fans and refrigerators. For the proposed pico-hydro system, however, the generating capacity is much lower compared to the existing pico-hydro system at rural area. Thus, the main function of the proposed system is for battery charging. A battery allows the future use of small electrical loads and can be recharged when required. Examples of future use of small loads particularly during

electricity blackouts are LED lighting, mobile phone battery charging and toys battery charging.

There are two common types of rechargeable batteries used for providing power to small loads which are lead-acid and nickel-cadmium (Ni-Cad). Battery size depends on the generating capacity of the proposed pico-hydro system and its application. For this type of pico-hydro system, Ni-Cad battery is preferred and more practical as it is easier to handle and reliable. Moreover, Ni-Cad is the opposite to lead acid in that it performs better and last longer if fully discharged before re-charging. On the other hand, lead acid batteries should not be fully discharged as this damages them.

III. DEVELOPMENT OF PICO-HYDRO SYSTEM

In general, the major concern in the development of the proposed pico-hydro system are civil works for small scale piping system or penstock from the consuming water outlet to the turbine and fabrication of the turbine (blades and drive shaft). Both parts determine the functionality and performance of the proposed system. Figure 5 shows the proposed pico-hydro system that has been developed.

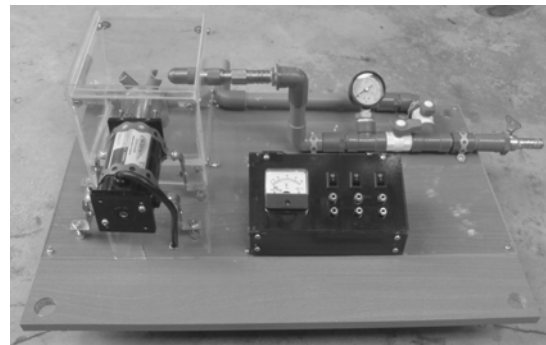

Fig. 5 Proposed pico-hydro system

A. Penstock

Figure 6 shows the layout of the proposed system. As noted in the layout, the pico-hydro system penstock begins from the water inlet to the turbine. The water inlet must be directly connected to the existing end user water outlet for water intake. The water intake point for the system to be mounted must be strategic and practical in implementation to provide dual function of the pico-hydro system, i.e. for electricity generation and routine activities. Strategic water intake depends on the water pressure level, whilst the practical application is defined as routine activities that are going to be done. In order to offer the dual function, the pico-hydro system provides water outlet from the turbine. Water from this outlet is water that used for turbine rotation can be re-used for household routine activities.

The penstock is equipped with "Power Valve" and adjustable nozzle to control the rate of water flow (amount of water) and water pressure respectively to optimize the turbine speed. It is also equipped with pressure gauge to measure the water pressure that represents the net head of the pico-hydro system. The pressure gauge is also necessary to monitor the

water pressure level so that the user able to know the most optimize pressure level for power generation. Bare in mind, pressure and flow rate vary between residential areas.

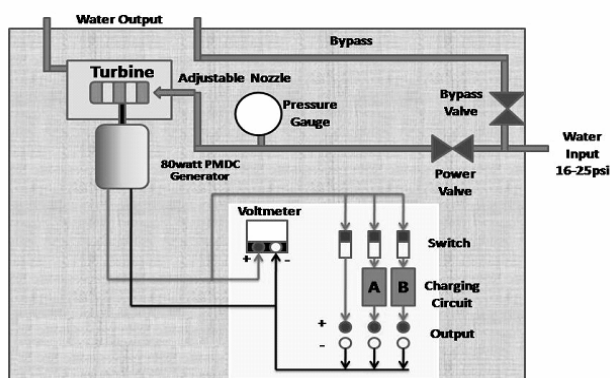

Fig. 6 Layout of the proposed pico-hydro system

In addition to the penstock, the piping system of the pico-hydro system is provided with a bypass pipeline via a “Bypass Valve” to reduce the wear and tear effect of the generator. When consumer not use this system, they can bypass the water flow by closing the “Power Valve” to the turbine and opening the “Bypass Valve” to the bypass pipeline. Therefore, the generator will not operate all the time until it is required by the user.

B. Pelton Turbine

Pelton turbines are suitable to high head, low flow applications. It can be outfitted with one, two, or more nozzles for higher output. Typically, when using this type of turbine, water is piped down a hillside so that at the lower end of the pipe, it emerges from a narrow nozzle as a jet with very high velocity to the turbine blades. The similar concept of water jet is also utilized in the proposed pico-hydro system; instead the water is tapped from the domestic consuming water outlet.

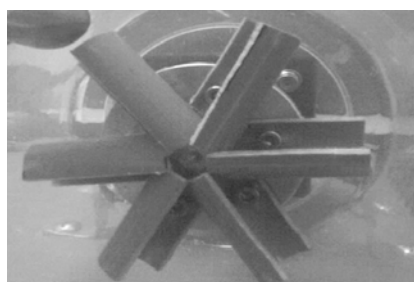

Fig. 7 Turbine for the proposed pico-hydro system

After a series of performance test on various constructions of Pelton turbine blades, the turbine with 6 cups fabricated from polyvinyl chloride (PVC) as shown in Figure 7 is used for the proposed system. The advantages of using PVC are less expensive and not require specialist to fabricate the turbine blades. Meanwhile, the base that associated with the drive shaft (rotor) for the turbine blades mounting is fabricated from aluminum with 80mm diameters. Small size of

turbine is important to ensure the generator shaft to rotate at an optimum speed.

C. Battery Charger

As illustrated in Figure 6, the generator output is connected to the charging circuits for energy storage purpose. Simple charging circuit as shown in Figure 8 is used. The battery charger is suitable for 9V to 12V batteries. For charging purpose, the maximum load current is limited to 1.5A. This is based on the maximum load current of the LM317 voltage regulator and the maximum current at continuous duty of the generator. In addition, due to the generating capacity of the pico-hydro system, Ni-Cad battery is preferred. Figure 6 also illustrates that there is a point of direct output from generator. This is to offer other application that might be relevant.

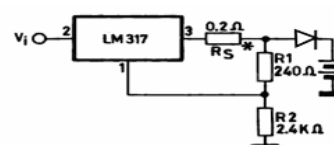

Fig. 8 Simple battery charger using LM317 voltage regulator

IV. CONCLUSION

In conclusion, there are two input parameters which are very important in ensuring the developed pico-hydro system to function as an alternative electrical power generator for residential use. The parameters are the pressure of the main pipeline water supply that representing the head (falling water) and the water supply flow rate. These parameters vary between residential areas. Hence, it is essential to determined both parameters at early stage for potential output power estimation.

Since the friction loss might be different between residential, the use of adjustable nozzle is another solution to vary pressure accordingly in compensating the friction loss by achieving optimum pressure value. In addition, the selection of turbine and generator in terms of their type and size or capacity is also important in designing and developing the proposed pico-hydro power system. Wrong type and improper sizing of these components would cause the system to operate at undesirable performance.

The next paper will describe the testing conducted to investigate the performance of the proposed pico-hydro system and discuss on the testing results. The results will show the overall performance of open circuit test, charging ability and maximum power generated.

REFERENCES

- [1] N. Smith and G. Ranjithkar, “Nepal Case Study–Part One: Installation and performance of the Pico Power Pack,” *Pico Hydro Newsletter*, April 2000.
- [2] P. Maher. “Kenya Case Study 1 at Kathamba and Case Study 2 at Thima.” Available: <http://www.eee.nottingham.ac.uk/picohydro/documents.html#kenya>
- [3] P. Maher and N. Smith, “Pico hydro for village power: A practical manual for schemes up to 5 kW in hilly areas,” 2nd ed., Intermediate Technology Publications, May 2001.

- [4] J. Mariyappan, S. Taylor, J. Church and J. Green, "A guide to CDM and family hydro power," Final technical report for project entitled *Clean Development Mechanism (CDM) project to stimulate the market for family-hydro for low income families*, IT Power, April 2004.
- [5] A. Williams, "Pico hydro for cost-effective lighting," *Boiling Point Magazine*, pp. 14-16, May 2007.
- [6] A. Harvey, A. Brown, P. Hettiarachi and A. Inversin, 'Micro hydro design manual: A guide to small-scale water power schemes,' Intermediate Technology Publications, 1993.