

File Copy

Raising meat rabbits



Agriculture
Canada

Publication 1782 E



630.4
C212
P 1782
1986
(1988 print)
c.3

Canada

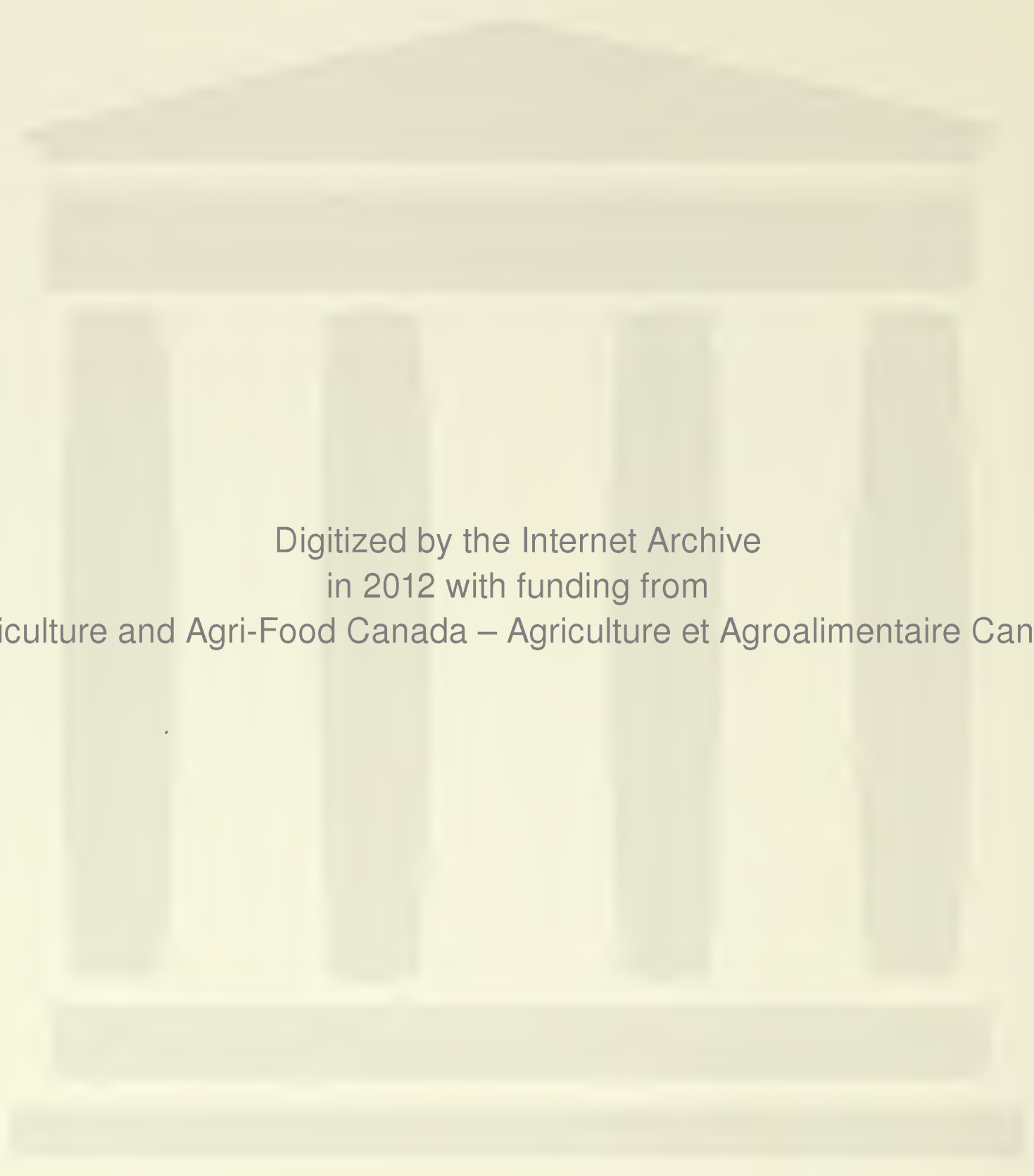

Digitized by the Internet Archive
in 2012 with funding from
Agriculture and Agri-Food Canada – Agriculture et Agroalimentaire Canada

<http://www.archive.org/details/raisingmeatrabbi00cana>

Raising meat rabbits

PUBLICATION 1782/E, available from
Communications Branch, Agriculture Canada,
Ottawa K1A 0C7

©Minister of Supply and Services Canada 1986
Cat. No. A63-1782/1986E ISBN: 0-662-14987-4
Printed 1986 Reprinted 1988 8 M-1:88

Également disponible en français sous le titre
Élevage du lapin de chair.

ACKNOWLEDGEMENTS

Agriculture Canada thanks Alberta Agriculture for permission to use the information in *Raising Meat Rabbits in Alberta*, originally prepared by Briarpatch Farms Ltd., Ardrossan, Alberta, and Lee Coates of the Canadian Rabbit Council for his comments on the manuscript.

**This publication replaces Publication 1200, *Raising Rabbits*.
Également disponible en français sous le titre *Élevage du lapin de chair*.**

CONTENTS

- WHY RAISE RABBITS? / 5**
- GETTING STARTED / 5**
- THE SIZE OF YOUR OPERATION / 5**
- MARKETING / 5**
- CHOOSING A BREED / 6**
 - New Zealand White / 6
 - Californian / 6
 - Champagne d'Argent / 6
 - Flemish Giant / 6
 - Florida White / 7
- SELECTING FOUNDATION STOCK / 7**
 - Visual assessment / 7
 - Record assessment / 7
 - Age of stock / 7
 - Buying entire rabbitries / 7
 - Buying the buck / 8
 - Tattoos and pedigrees / 8
 - Registered stock / 8
- THE BUILDING / 8**
 - Layout / 9
 - Construction and design / 9
 - Heating / 9
 - Ventilation / 10
 - Lighting / 10
 - Costs / 10
 - Professional advice / 10
- EQUIPMENT / 11**
 - Cages / 11
 - Watering equipment / 12
 - Feeding equipment / 13
 - Nest boxes / 13
 - Other equipment / 14
- RABBIT NUTRITION / 14**
 - Digestive system of the rabbit / 14
 - Nutritional requirements / 14
 - Feedstuffs / 15
 - Methods of feeding / 16
 - Medicated feeds / 17
 - Feed storage / 17
 - Nutrition and disease / 17
 - Changing rations / 18
- REPRODUCTION / 18**
 - Fertility / 18
 - Gestation period / 18
 - Breeding age / 18
 - Mating / 19
 - Determining pregnancy / 19
- BREEDING PROBLEMS / 20**
 - Pseudopregnancy / 20
 - Sterility / 20
 - Neonatal deaths and abortions / 21
- RAISING THE LITTER / 21**
 - Kindling / 21
 - Care of the young litter / 21
 - Fostering / 22
 - Causes of death among newborns / 22
 - Lactation / 22
 - Causes of death after 3 weeks of age / 23
 - Weaning / 24
- DISEASES AND ABNORMALITIES / 24**
 - Stress / 24
 - Diseases / 24
 - Abnormalities / 26
- HERD MANAGEMENT / 27**
 - Handling rabbits / 27
 - Tattooing / 27
 - Determining sex / 28
 - Castration / 28
 - Sanitation and disease control / 28
 - Consulting a veterinarian / 29
 - The use of drugs / 29
 - Laboratory diagnosis / 29
 - Daily management schedule / 29
 - Breeding programs / 29
 - Further considerations / 30
- SELECTING REPLACEMENT STOCK / 30**
 - Methods of improvement / 30
 - Progeny testing / 31
 - Replacement numbers / 31
 - Selecting does / 31
 - Selecting herd bucks / 31
- GENETICS AND BREEDING SYSTEMS / 32**
 - Genetics / 32
 - Traits / 32
 - Breeding systems / 32
- RECORD KEEPING / 33**
 - The doe card / 33
 - The buck card / 34
 - The daily work card / 34
 - Feed conversion ratio / 35
 - Herd production summaries / 35
 - Financial records / 35
 - Pedigree book / 36
 - Using home computers / 36
- PROBLEMS OF EXPANSION / 36**
- GLOSSARY / 38**
- ENDNOTES / 39**
- REFERENCES / 40**

WHY RAISE RABBITS?

The rabbit has great potential as a meat source. In the future, it may well become one of the most important livestock species. In a world with a rapidly growing population to be fed, animals that can eat forages will have an advantage over those which must be fed grain. Rabbits can eat high-forage, low-grain food that is not used by humans. Of all livestock, rabbits utilize forage most efficiently. Furthermore, they grow quickly, reproduce readily and have a high degree of genetic diversity.

Rabbit meat is very nutritious. It has little unsaturated fat and cholesterol, making it good for coronary patients. It also has less sodium than red meat but contains about the same amounts of iron and vitamins.

Nutritional values of common meats¹

Edible portion, uncooked	Protein (%)	Fat (%)	Moisture (%)	Cal/kg
Rabbit	20.8	10.2	67.9	1765
Chicken (frying)	20.0	11.0	67.9	1798
Veal (medium fat)	19.1	12.0	68.0	1865
Turkey (medium fat)	20.1	22.2	58.3	2642
Lamb (fat)	15.7	27.7	55.8	3152
Beef (fat)	16.3	28.0	55.0	3197
Pork (medium fat)	11.9	45.0	42.0	4551

¹ Robert Bennet, *Raising Rabbits the Modern Way*, Garden Way Publishing, Vermont (1975), p. 35

GETTING STARTED

Raising rabbits is not an easy way to quick riches. However, in return for your interest, effort and a reasonable capital outlay, you can produce wholesome meat for your home, realize a small profit and collect the best organic manure available. However, you'll need some knowledge and experience even for a small rabbitry. The training ground for any rabbit raiser is the school of practice. The best possible advice to give a novice is to begin on a small scale. Expand

only when you've gained experience so any errors will be less costly.

It is important to begin with no more than 20 does and two or three bucks. A rabbitry of this size will provide a wide variety of experience in rabbit husbandry. If, after a full year's practice, you decide to continue raising rabbits, you should have developed a good starter herd. If, on the other hand, you decide raising rabbits is not feasible, you can easily dispose of the herd. A small operation, whether a success or a failure, will not be costly.

THE SIZE OF YOUR OPERATION

Your time, money and experience should determine the size of your rabbitry. A small backyard operation containing a buck and three or four does will furnish enough meat to vary the diet of the average family. One with 20-200 does will provide part-time employment. For example, a 100-doe

rabbitry requires about 4 hours per day. Working full time, a two-person team could handle approximately 600 does. One couple might care for 500 does and be successful, but the rabbitry must be well-constructed, well-managed and automated.

Whatever the size of the operation, a market is essential and must be established before the rabbit raiser proceeds.

MARKETING

How you market your rabbits will be governed by your provincial meat inspection legislation. Unless you limit your operation to "farmgate" sales of live rabbits, you will need access to a processor. If any are operating in your area, talk to them (as well as to other rabbit raisers) to find out the extent of their business, the demand for fryer rabbits, the stability of the market and buying prices, and whether or not pick-up is included. The nearer the rabbitry is to the processor, the better. Transporting live rabbits over long distances is not profitable because of high fuel and labor costs, and the weight lost by transported animals.

Ideally, fryers should be sold at 8-10 weeks of age when they weigh about 2.2-2.5 kg. Culls from breeding herds may be fattened as roasters, but the market is limited, and they bring

reduced prices.

Raising fur breeds solely for their hides is not profitable because of the expense of raising the animals to adulthood with a prime coat.

Laboratories are profitable outlets but require rabbits that meet exacting specifications and are of known disease-free strains produced under optimum conditions.

The pet store market is limited and seasonal.

Many veteran raisers supplement their rabbitry's income by selling breeding stock, because quality breeding animals are always in demand. Nevertheless, they still need a regular market for their culls and extra rabbits.

Producers of rabbit meat must advertise their product to increase sales. The general public is unaware of both the value and the fine flavor of domestic rabbit.

CHOOSING A BREED

There are over 30 breeds of domestic rabbit in North America but only the heavier ones are used for commercial meat production. As some of the heaviest are slow maturing and dark fleshed, the New Zealand White and Californian are those most widely raised for meat. They grow rapidly and have a square blocky build. They have a good meat-to-bone ratio and firm white meat.

Processors prefer white rabbits, primarily because dark hairs inadvertently left clinging to a carcass are unsightly. In some areas, processors pay less for colored rabbits.

A rabbit raiser need not be restricted to one breed. For example, many commercial producers breed Californian bucks with New Zealand White does to produce vigorous offspring for the fryer market.

You may try several breeds before settling on the one you like best. For more information on rabbit breeds, you may wish to read the Official Guide of the American Rabbit Breeders' Association.

New Zealand White



Figure 1 New Zealand White

This breed was developed in the United States for commercial use, and is the most popular meat rabbit. It is white with bright pink eyes and prominently veined ears. The body is medium length, full through the hips and loins with proportional shoulders. Mature bucks weigh about 4.5 kg; does weigh about 5.0 kg. The average litter size is 8-10.

Californian



Figure 2 Californian

This breed was also developed for commercial use in the United States. It is white with brown or black ears, nose, feet

and tail, and pink eyes. The body has plump hips, a meaty saddle and broad shoulders but is small boned. The bucks weigh about 4 kg; does, 4.3 kg. The litter size is 6-8.

Champagne d'argent



Figure 3 Champagne d'argent

One of the oldest known breeds of rabbits, the Champagne d'argent is black at birth, gradually changing to silver with a slate blue undercoat. The whole coat is evenly interspersed with longer black hairs, and the eyes are brown. It is medium length with well-developed hindquarters, shoulders and back. The bucks weigh about 4.5 kg; does, 4.8 kg.

Flemish Giant



Figure 4 Flemish Giant

This is another very old breed which is popular in Europe. As the name suggests, the Flemish Giant is very large but well-proportioned. It has dark brown eyes and long ears. The fur can be white, fawn, gray, sandy, blue or black. The body is big boned with heavy hindquarters. The doe has a larger dewlap. The bucks average 6.5 kg; the does, a hefty 7 kg.

A recent study at Oregon State University¹ found Flemish Giant does did not reproduce as well as New Zealand White does. The Flemish Giant does had a lower conception and litter survival rate, a longer interval between litters, and poor feed efficiency from kindling to 21 days.

Florida White



Figure 5 Florida White

The Florida White was developed to meet the demand for small fryers and smaller white laboratory rabbits. The breed is becoming more popular for home meat production and crossbreeding.

The fur is white with good density and texture. It has pink eyes, a compact, meaty body, a short neck, and a small head. Both bucks and does weigh only about 2.3 kg.

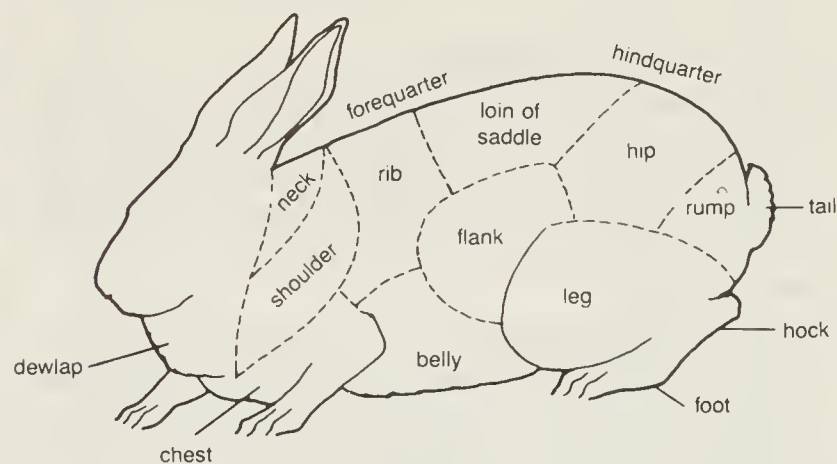

Figure 6 Diagram of rabbit showing sections and parts

SELECTING FOUNDATION STOCK

Having decided upon a breed, your next step is to find stock. It takes several years to build up a good herd so it's important to start with the best animals available. A local processor can help you contact reputable breeders. Rabbit clubs and associations are another source for information. Your provincial department of agriculture may be able to supply you with addresses. Visit several breeders before buying any animals, and if it's possible, buy them from a successful commercial producer. Don't bring them home until your rabbitry is completely set up. Even the best stock won't breed to potential in inferior housing.

To find the best stock, two things to look at are the appearance of the rabbits and the records of the rabbitry.

Visual assessment

When visiting any rabbitry, check the entire rabbitry for cleanliness, contented calm stock, and an abundance of plump young rabbits. Note the number of young in each litter, and the number of does with litter (two-thirds of the working does should have litters). The building should be free from strong ammonia fumes and sneezing rabbits.

Examine each rabbit being considered for purchase closely. Look for animals that are good examples of the breed, and healthy and alert. Avoid nervous animals. Check that the coat is in good condition. Beware of woolly, sparse or dull fur. The eyes should be clear and bright, not weepy. The teeth should be neither yellow nor deformed. The rest of the animal should be clean, dry and plump. Be on the lookout for scabs and sores anywhere on the body. They are usually symptoms of disease, and rabbits with them should be avoided.

Record assessment

While appearance is important, so are records. Avoid

breeders who do not keep them (or will not show them). The records will tell you the performance of the rabbitry. Look first at breeding information. Good does conceive easily, produce 6-8 litters each year, and about 15 litters during their life. The average litter size should be seven or more, with few losses of young. However, beware of a breeder claiming no losses; even with excellent husbandry some are inevitable. The young should grow rapidly, reaching 2.2 kg at 8 weeks. Check the cost and quantity of the food eaten to see if there is efficient food conversion. Finally, look at the family history of the rabbits for ancestors with good performance records.

Age of stock

If you buy mature rabbits, you can start production quickly. You can also get a good indication of their meat traits. They are more disease resistant and tend to adjust well to new surroundings, but give them a couple of weeks to adapt before breeding them. You will pay more for older stock and you run the risk of getting stuck with ill-tempered animals that are "set in their ways".

If you want to have a hand in the feeding and upbringing of your new herd, buy young rabbits. They are cheaper, more readily available and will adapt to their new surroundings easily. The drawbacks are they don't yet show all their adult traits and, of course, you have to delay breeding until they mature.

One solution is to buy does of varying ages (e.g., 3 months, 4 months and 5 months of age). They can then be eased into production a few at a time.

Buying entire rabbitries

Entire rabbitries are frequently advertised for sale. Before you buy, find out why the owner is selling. If the operation was unsuccessful, make sure you don't end up buying the problems that led to failure.

Buying the buck

Buy a good buck; its value is often half that of the total herd, and it has a vital role to play in improving your stock. Buy an experienced animal — a maiden doe is more easily bred by a proven stud. You should also buy a junior buck as a backup stud.

Tattoos and pedigrees

Breeders tattoo the left ear of their rabbits for identification. The right ear is saved in case the animal is registered by an official of the American Rabbit Breeders' Association (ARBA). A tattoo is no guarantee of quality. The ARBA tattoo means the animal is purebred, but it still may be a poor producer.

A purebred rabbit is one bred to meet a recognized standard. If it has a written record of its ancestry, it is a pedigreed rabbit. The pedigree should contain information about the animal and at least three generations of ancestors on both sides of the family. For each rabbit, it should include: name and ear number, registration number (if registered), color and markings, sex, weight, date of birth, show winnings and grand champion numbers.

A pedigree is only as good as the honesty and integrity of the breeder who produced it, but without it the rabbit isn't considered purebred.

Registered stock

Registered stock is of great importance to those who show their rabbits. Registered champions conform to breed standards, but they don't necessarily meet the main requirement of the commercial rabbit raiser, which is meat production. Registered commercial stock is rare.

However, if you wish to register a rabbit, you must be a member of ARBA. The animal must be a mature purebred, with a three-generation pedigree. A licensed ARBA registrar examines it for defects and makes sure it meets the requirements of the breed standard. Even the offspring of registered parents must be individually examined. The registrar tattoos the registration number in the right ear, then completes an application which includes the pedigree and information on the rabbit's conformation and history. If the application is approved, the ARBA issues a certificate of registration.

There are three categories of registration: a plain seal means the rabbit has no registered ancestors; a red seal means the parents and grandparents are registered; and a red/white/blue seal means all ancestors are registered. Any break in registration means the line must start all over again. If, for example, a doe from registered parents dies unregistered, her offspring must be registered with the plain seal.

THE BUILDING

You can convert existing buildings — such as hog barns or toolsheds — into rabbitries. However, it is less expensive and more efficient to build from scratch. Check the zoning by-laws and building code in your area before starting construction.

Choose a sheltered site. Rabbitries in northern climates usually run east-west to maximize exposure to the winter sun. Trees or shelterbelts deflect wind, while shade trees

filter summer sun. Make sure the soil drains well and a steady supply of drinking water is available.

The size of the building depends on how many rabbits you have, the type of cages you use, your breeding program and your bank account. Commercial rabbitries are similar in construction to commercial poultry buildings. A rectangular structure is recommended as the most efficient design. It is easily extended if you want to accommodate a bigger herd.

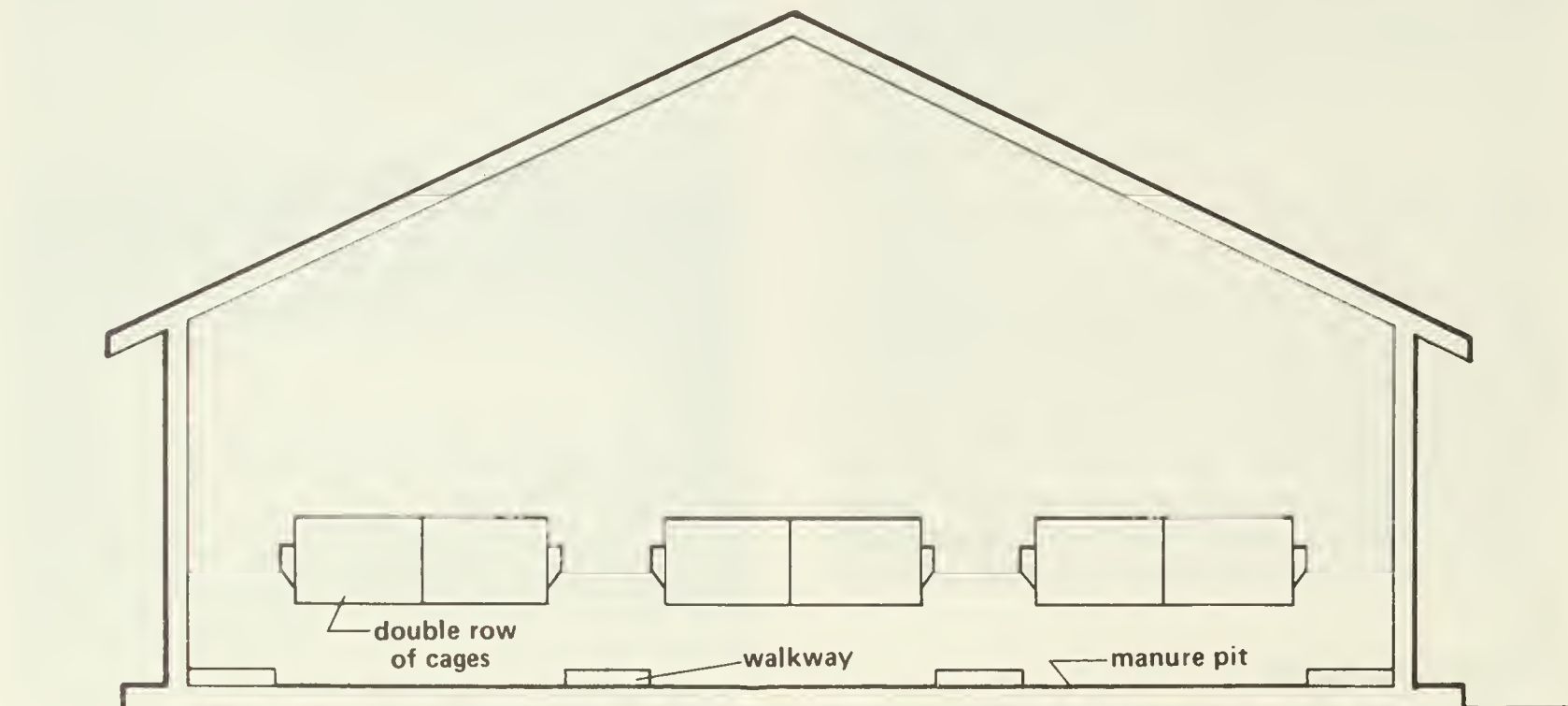

Figure 7 End view of barn showing spacing of cages

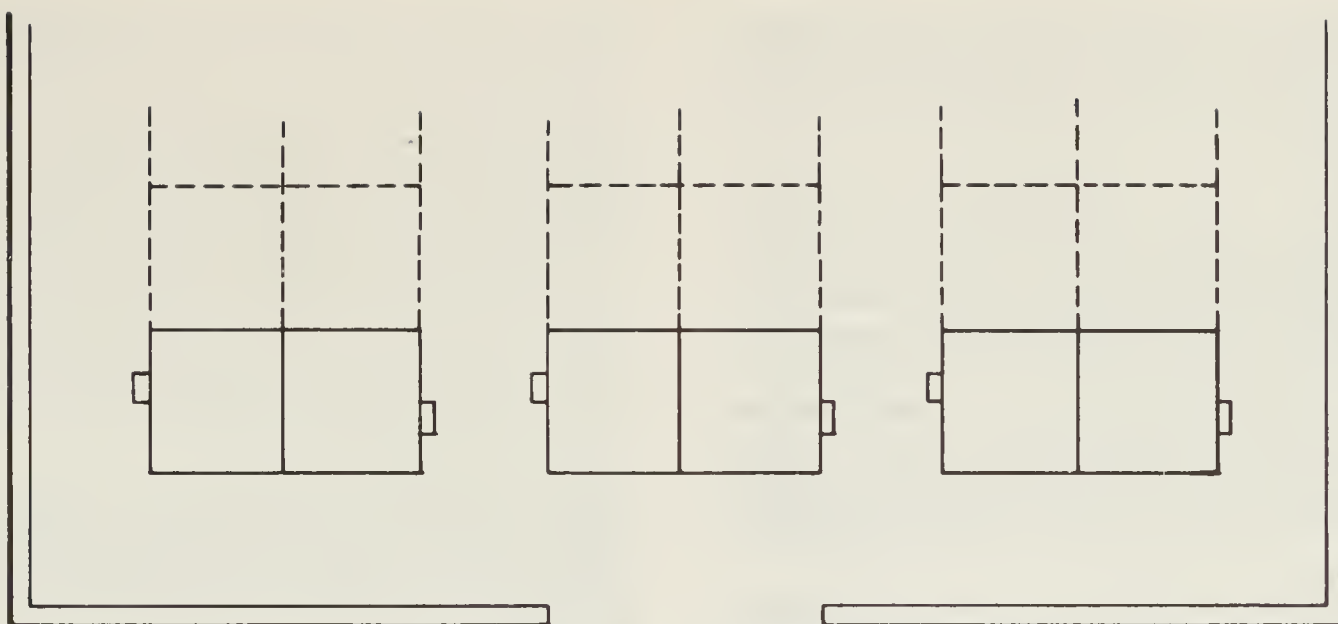

Figure 8 Top view of barn showing cage layout

Layout

A clear-span building is easier to plan, but more expensive to build than a post-and-beam one. For the latter, the posts must be spaced to fit the cages.

The aisles between the cages should be at least 90 cm wide. However, the actual walkways should be narrower so the manure pits can extend in front of the cages. This will keep the walkways clear of manure and urine. Put storage and supply areas at one end of the building. Long rows are more readily adapted to mechanization, for example, automatic manure scrapers, than short ones.

Each rabbit needs 0.7 m² cage space. The standard size is 75 cm depth × 75 cm front width. Cages are best arranged in double rows down the center of the building. This allows air to circulate around them and makes manure easy to remove. There should be about 3 m space at the ends of the rows to allow movement of equipment from one aisle to the next.

The measurements for the building shown in Figures 7 and 8:

Cage floor (width × depth): 75 cm × 75 cm

Number of cages: 6 across building

Total cage area: 0.7 m² × 6 = 4.2 m²

Aisle width: 90 cm

Building width: 8.54 m

Floor area of building: 7.8 m² (for 6 cages plus aisles)

Total floor area per standard cage: 7.8 m² ÷ 6 = 1.3 m² (including aisle)

With 3 m extra space allowed at each end of the rows, 1.58 m² of building area per standard cage will be required.

After laying out the floor plan you can determine the total building space required. If the building described above was 33.55 m long, it would have the capacity for 180 single-tiered cages.

Construction and design

Build with year-round production in mind. The rabbitry should be easy to work in, clean and disinfect. The main area should hold the doe pens and the growing pens. The

replacement stock and breeding bucks can be in this area as well.

The rabbitry can also have two isolation units: one for sick rabbits and one for newly acquired stock (these can be in different buildings altogether). There should be a clean, dry and pest-free feed storage area. You should also have a work table where rabbits can be palpated, tattooed, etc.; a place for cleaning cages, storing nest boxes, etc.; and an office where records are kept.

Concrete floors are not recommended because they do not dry well and concentrated urine produces ammonia fumes. It is better to use gravel manure pits (with some slope or tile-enhanced drainage) under the cages and to pour concrete walkways between them. Concrete footings should be poured around the perimeter of the building.

Before ordering the roof trusses, determine the weight that will be hanging from them: cages, feed and feeders, water and watering equipment, nest boxes and rabbits. The walls of the building should be insulated with a minimum of R20 and the ceiling with R30 to avoid temperature extremes. The interior walls should be ammonia- and moisture-proof for easy cleaning and disinfecting.

Heating

For year-round production, rabbits must be protected from direct sunlight, radiating heat and high temperatures. A mature buck can become temporarily, or even permanently, sterile if exposed to temperatures of 29°C for five consecutive days. On the other hand, if the rabbitry is too cold, newborns may die from exposure. The doe will be reluctant to pull her fur to line the nest box if she herself is cold.

Rabbit raisers don't agree on the ideal temperature. Some maintain a minimum temperature of 2°C is adequate. This is just warm enough to keep the drinking water from freezing. However, many raisers say their animals are most productive at temperatures between 15-18°C. In any case, avoid extremes, especially in any single day. A constant temperature helps promote regular breeding.

The two most commonly used heating systems are hot air and hot water. The hot air system is cheaper and easier to install, but more costly to operate. It also causes problems

with fluctuating drafts. The hot water system is more efficient to operate. It maintains a more uniform temperature which reduces stress on very young rabbits.

Ventilation

Heating is less of a problem than ventilation. When it is cold rabbits consume more food, carry more fat and grow thicker fur. They can do little to compensate for the air they must breathe. During intense summer heat, they consume less food and drink more water, but they cannot shed their fur coats. Good ventilation can keep down losses from heat prostration and can reduce heat-produced sterility. Moving air has a cooling effect which can be increased by adding evaporation units or mist cooling techniques to the ventilation system.

Even in the smallest rabbitry it is worthwhile installing a mechanical fan ventilation system controlled by timers and thermostats. A totally controlled housing environment is the ideal situation, but the cost of an automated system may be prohibitive for small operations.

A good ventilation system must bring in fresh air without causing drafts or discomfort for the rabbits. The air should be changed at least four times each hour in the winter, bringing in as much fresh air as possible without losing too much heat. In extreme cold, reduce the air exchange to one per hour. Up to 16 changes are needed during hot weather. Warm air must be removed and the temperature controlled.

It must remove excess moisture and control humidity. Relative humidity below 50% will dry nasal passages while that above 60% will cause respiratory distress among the rabbits and will lead to an increased incidence of respiratory problems in the herd. Dust, bacteria and viruses must also be removed.

It must remove toxic fumes. The manure of many animals in a confined space, particularly in winter, will create ammonia. An ammonia level of 20 ppm or higher is considered harmful to rabbits. If the fumes irritate your eyes and nose, they will certainly irritate the stock. The solution here is not just good ventilation. You must also remove the manure so fumes do not build up.

There are three common ventilation systems, each has both advantages and disadvantages.

Negative pressure This system is commonly used in all types of livestock buildings. Fans mounted at or below floor level pull air out of the building while air inlets control the air let in. The result is a partial vacuum (low pressure area) inside the building, which creates a uniform movement of air. This system has no negative effect on the animals. One

minor problem is loose rabbit fur tends to build up on the fan blades, so they must be cleaned frequently.

Positive pressure In this system the fans are mounted to draw fresh air into the building, creating high pressure inside. This system works well in older structures because the air is forced out through cracks, preventing cold drafts coming in. However, drafts are caused by the fans blowing air into the barn. An air bag system helps prevent drafts and uniformly distributes the air. This system is not affected by loose fur but the drafts and recycled air can cause respiratory problems and spread germs.

Natural ventilation This system is normally used in a building with a high, open ceiling. It is unsuitable for rabbits because it works on the principle of warm air rising, which brings ammonia and bacteria from the ground up to the cages.

Lighting

Opinions differ on the effects of lighting upon rabbit production. Some raisers only turn on the lights when working in the building. Bucks appear to mature more quickly and have a higher semen concentration on short days (8 hours of light). Does, on the other hand, seem to require longer days (a minimum of 16 hours of constant low light) to maintain year-round production.

Does exposed only to natural light have a fall barren period when the days begin to shorten. This can be reduced if they are kept under lighting that mimics the longest days of summer in June. This can be done using a time clock to control the lights. The amount of illumination required depends on the latitude you live at.

Although experiments are under way, little is known about the quality of light (incandescent versus fluorescent; daylight blue versus purplish-pink, etc.) and intensity of lighting which best promotes production.

Costs

The minimum cost (1981) for the construction of a basic rabbitry with the features advocated in this chapter is \$160/m². Variables altering the basic cost are heating and ventilation. Additional expenses, such as land costs and the cost of drilling a well or bringing in a gas line, are not included in the basic figure.

Professional advice

Whether constructing a new rabbitry or renovating an existing building, you should make use of the engineering services provided by your provincial department of agriculture.

EQUIPMENT

Cages

Cages are hung from the ceiling at a convenient working height, with the cage floor at least 75 cm off the ground. This makes it easier to clean underneath them. They are usually built and hung back-to-back in double rows.

Standard cages are usually 75 cm deep by 75 cm wide by 38 cm high. They are made of wire. If you make your own use 14 gauge welded galvanized wire 12.5 mm × 25 mm for the floors. The sides can be made of 25 mm × 25 mm, or 25 mm × 50 mm 14 or 15 gauge wire. Use "baby saver" wire on the ends and sides to guard against the loss of young rabbits born outside the nest box. Ten centimetres of this wire is 25 mm × 12.5 mm mesh; the remainder is 25 mm × 25 mm. Make the cage tops of 25 mm × 25 mm wire, 14 or 16 gauge. They can be flat or arched (Quonset style).



Figure 9 Quonset style cages, single-tier

Cages for bucks, replacement stock and saleable stock can be smaller than the standard breeding ones, because each will house only one animal. Suggested sizes for these cages (depth × width × height) are: 45 cm × 60 cm × 38 cm, 60 cm × 60 cm × 38 cm, or 45 cm × 75 cm × 38 cm.

You must decide if you want single- or multi-tier cages. The single-tier ones are easier to build, install and clean.

They provide easy access to the rabbits. They can open from the top or the front. With the former, the entire top of the



Figure 10 Front-opening cage

cage may be raised from the front edge. The front-opening types must have a doorway large enough for rabbits and nest boxes to fit through. Some people find front-opening cages awkward. The disadvantage of single-tier cages is they use more space which increases the cost of construction and maintenance per working doe.

Multi-tier cages (two layers) require more effort to build and clean. They make more demands on the ventilation system and you must install dropping boards beneath each cage to catch the manure. The advantage is you can fit more rabbits in your building.

How many cages You will need 40-90% more cages than the number of breeding does you have, depending on your breeding program.

Extra cages give you more flexibility. In a 100-doe rabbitry, the actual number of breeding does may vary from 85-90 during the winter, to 110-115 in the summer. During the winter, the additional cages may be used for raising replacement stock for the coming summer and extra breeding stock for sale in the spring, when the demand is highest.

To estimate the number of cages required for rabbitries of various sizes on different breeding programs use the following calculations:

Extra cages needed for different breeding programs

Wean-to-market	28-35 day breed-back	14-21 day breed-back
<i>Percentage of extra cages required</i>		
10% buck	10% buck	10% buck
10% fattening	25% fattening	45% fattening
10% replacement	15% replacement	20% replacement
10% saleable stock	10% saleable stock	10% saleable stock

For example: A 100-doe rabbitry

	<i>Number of extra cages required</i>		
100 doe	100 doe	100 doe	100 doe
10 buck	10 buck	10 buck	10 buck
10 fattening	25 fattening	45 fattening	45 fattening
10 replacement	15 replacement	20 replacement	20 replacement
10 saleable stock	10 saleable stock	10 saleable stock	10 saleable stock
Total	140 cages	160 cages	185 cages

A large rabbitry with an accelerated breeding program requires nearly two cages per breeding doe. Cages are a large part of the expense of an operation.

An excellent and proven alternative to buying many extra cages is the split or European cage. It is standard size but

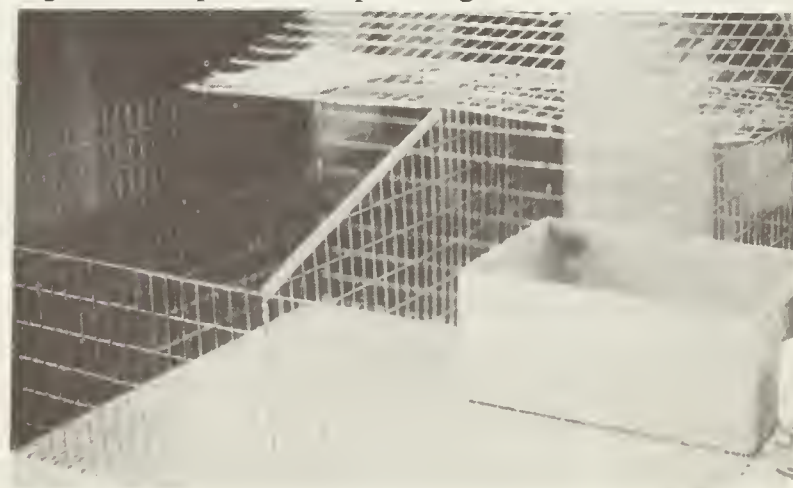

Figure 11 Split or European cage

divided in half by a wire partition with a door which allows the doe and her young to use the entire cage. When the young are weaned, the door is closed, separating them from their mother. This gives you more control over feeding and reduces stress on both the fryers and the doe. By the time the doe's next litter is ready to leave the nest box, the first litter has been marketed. The door of the partition is again opened, allowing them access to the entire cage. Split cages significantly reduce the space required per doe. They can also house two replacement rabbits. Each half, however, needs a feeder and a waterer.

Watering equipment

Rabbits need fresh clean water available at all times. Pop bottles inverted in cups or equipped with stoppers and drinking tubes are inexpensive but time-consuming, as they must be refilled often and cleaned regularly to prevent health problems. Even the smallest rabbitry benefits from an automatic or semi-automatic system.

The simplest watering system is semi-automatic. You fill a holding tank (perhaps just a large bucket) elevated above the hutches, and the water flows down through pipes alongside the cages. Valves are inserted into the pipe at each cage. The rabbits bite on the valves to release the water.

There are two types of valves. The "dewdrop" valve has a metal stem in it which is dislodged when bit or licked. This allows the water to trickle through. After a rabbit has stopped drinking, the stem drops back into the valve opening and is held in place by the water pressure. With a "pivoting" valve, the stem is on a spring. It bends out of the way during drinking, then swings back to stop the water flow. Pivoting and other spring-loaded valves are less sensitive to line pressure. They are better suited for small float-type systems where water pressure is not as controlled.

A fully automated watering system requires float tanks or pressure regulators. The latter are necessary if the water

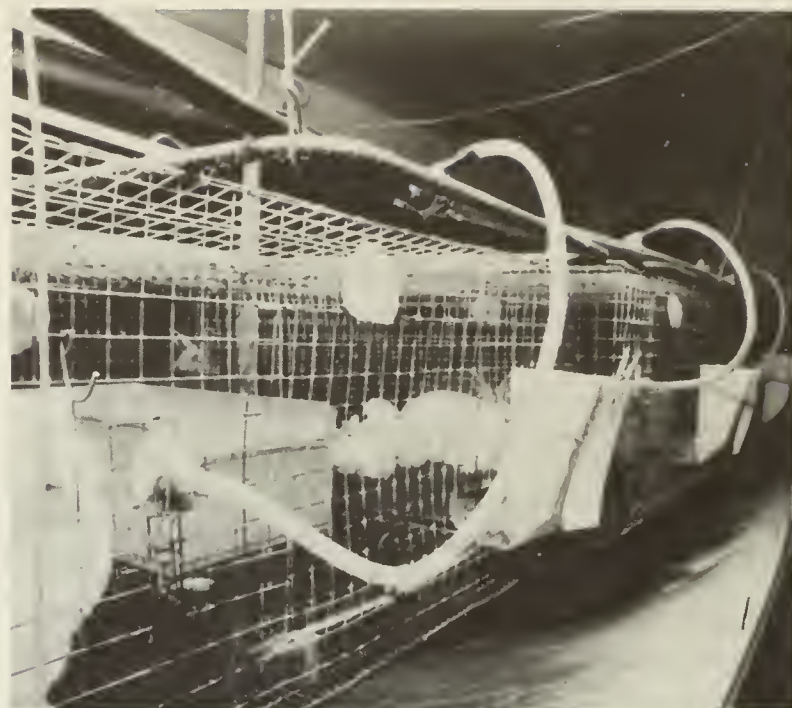

Figure 12 Automatic watering system

system is connected to a city water line or a farm pressure system. Pressure should be reduced to about 20.7 kPa. Steel, rigid plastic, or flexible plastic pipe may be used to carry water to the cages. Steel pipe is the most durable but also the most expensive to install. Flexible pipe must be supported with brackets to prevent sagging and air locks in the water line.

A complete watering system uses filters to remove mineral deposits and very small granular accumulations which can cause some valves to leak. Pressure that is too low will also cause leakage but pressure that is too high will restrict the rabbits' water intake.

Incomplete, improperly installed, or mismanaged watering systems may create problems leading to the death of young between 3 weeks and market age. Even a closed system must discourage the growth of harmful bacteria. Continu-

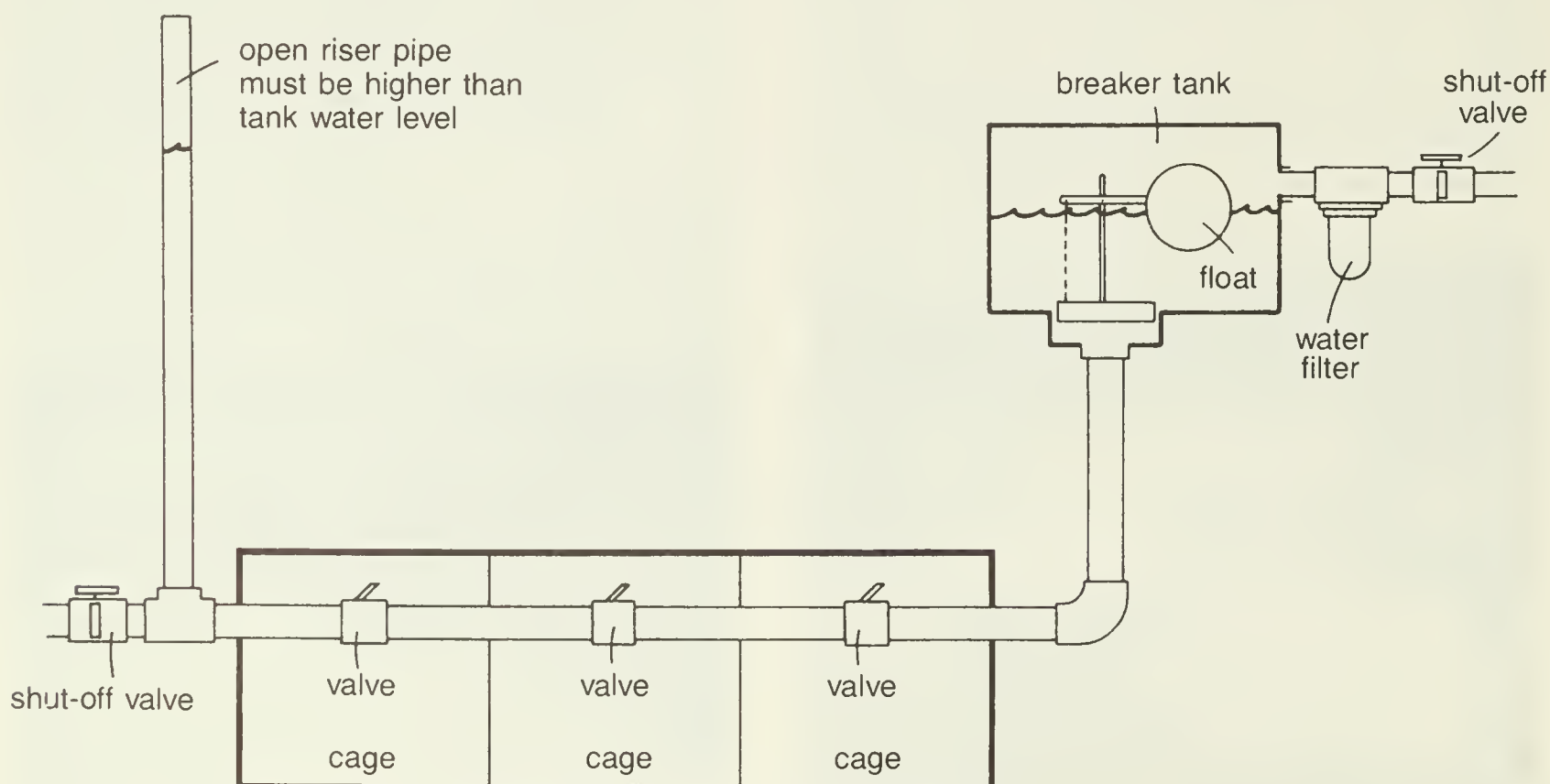

Figure 13 A simple gravity pressure watering system

ous superchlorination with 5 ppm of household chlorine bleach can protect the rabbits.

Feeding equipment

Feeders should be installed so they can be filled from outside the cages. They should be large enough to feed as many rabbits as the cage can hold. Metal feeders cannot be chewed, and are easily cleaned and disinfected. Various

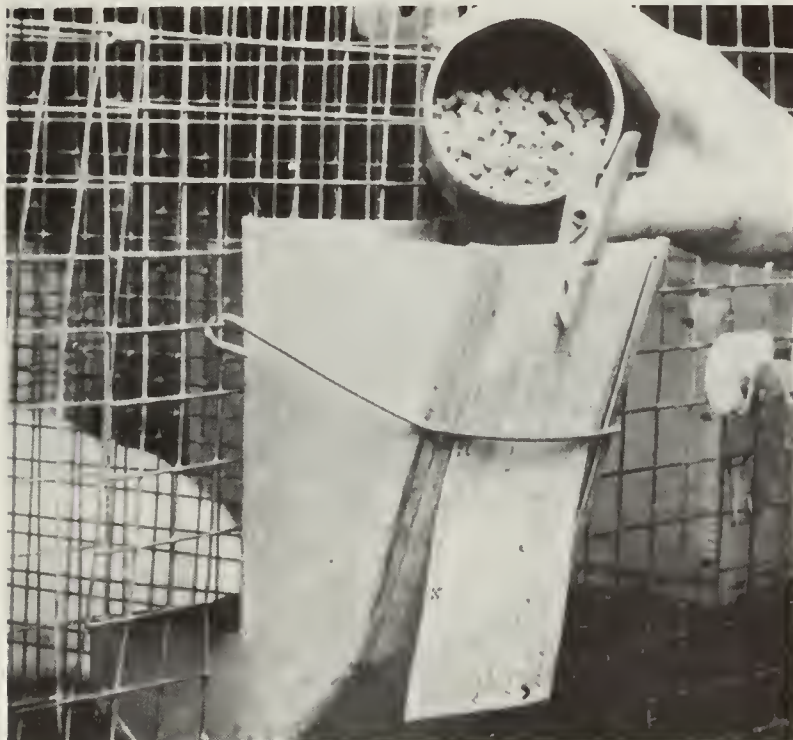

Figure 14 Metal feeder

types are available from supply houses. Some feeders have a fine screen at the bottom to permit feed dust (fines) to sift out. They should also have an inward-facing lip to prevent the rabbits from scratching out or contaminating the feed. Feeders that are installed completely outside the cage reduce feed losses the most.

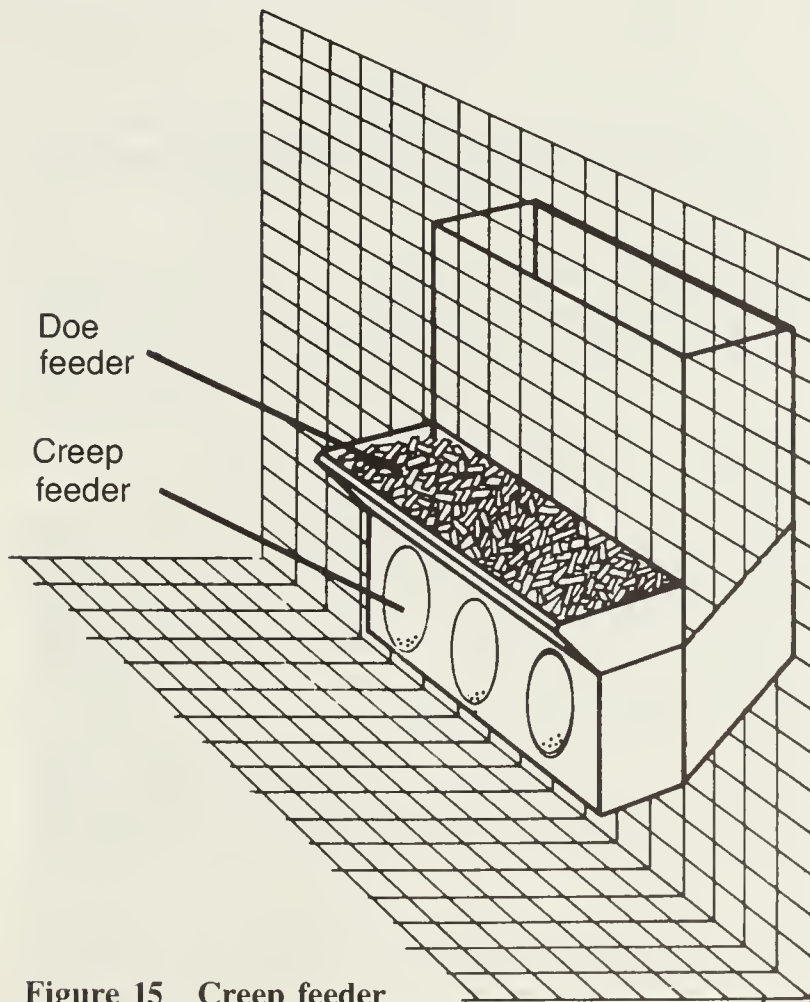

Figure 15 Creep feeder

Feeders should be 7.5-10 cm above the cage floor so the rabbits cannot contaminate the feed with droppings or urine.

Creep feeders can be used to feed young rabbits. Only they are small enough to reach through the holes in the side of the feeder and get at the food. This means they can be given different food than the doe.

You can make a hayrack simply by affixing a single sheet of wire or metal to the outside of the cage. Put hinges at the bottom and a small length of wire or chain to fasten the top of the rack to the cage. This forms a "V" which holds the hay against the cage. The rabbit then nibbles it through the wire.

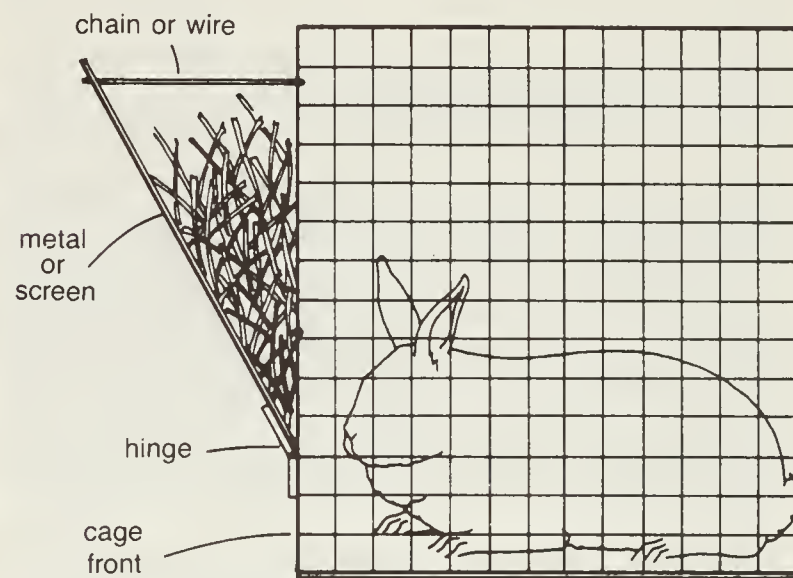

Figure 16 A simple hay rack

Hayracks are not necessary with single-tier, flat top cages, because hay can be spread on top of them and easily reached by the rabbits inside.

Nest boxes

Nest boxes provide privacy for the doe at kindling as well as comfort and protection for her young. They should be simple to clean and maintain, well-drained and well-ventilated.

There are many types of nest boxes. They can be made from plastic, masonite, wire, sheet metal or a combination of these. You can make them or buy them. Some nest boxes on the market are made of galvanized metal with disposable cardboard liners. These may be drier, but they are drafty in winter.

A typical design is 39 cm deep by 25 cm wide by 22 cm long. The front end is cut down to about 15 cm. Does seem to prefer covered nest boxes but they get damp and are difficult to clean and to inspect. A sheet of cardboard or an empty feed bag placed over the cage can make a fretful doe feel more secure.

Line the nest boxes with straw, shavings, shredded newspaper or some other absorbent bedding. Linings should be clean, pliable and nonedible. In winter you may wish to use additional insulation and heat lamps above the nest boxes.

Sunken nest boxes have tops flush with the bottom of the cage. They are supposed to prevent losses of young because any that crawl out or are carried out fall back in easily. Sunken plastic nest boxes that pull out from under the cages like drawers are now available. They are expensive and

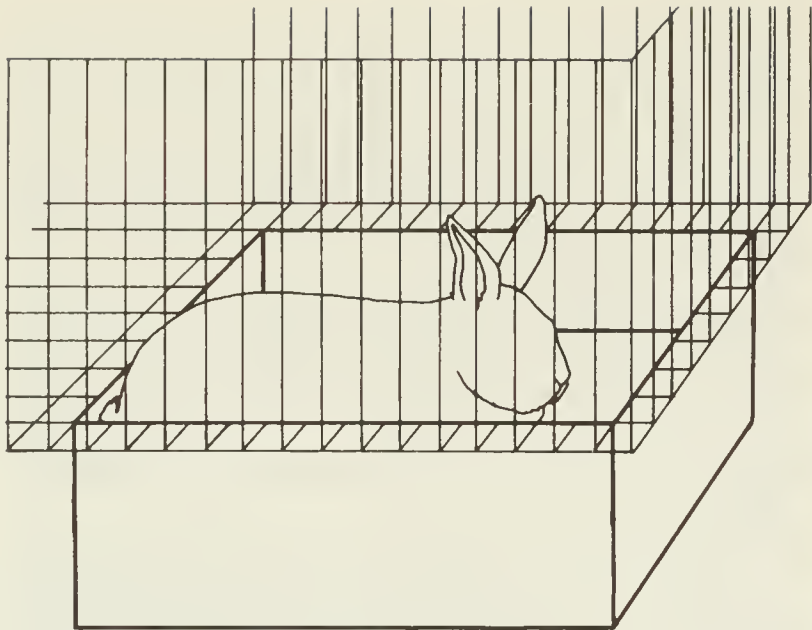

Figure 17 Sunken nest box

require more work but they provide a more native environment, as rabbits are burrowing animals by nature.

One problem with all nest boxes is that the urine of the young cannot be completely removed, and the dampness can lead to chilling, conjunctivitis and coccidiosis. A solution is modifying the box by building a wire mesh floor raised about 6.5 cm. Add a loose layer of wood shavings below the wire to insulate the bottom against cold and to absorb the urine.

If the doe defecates or urinates in a particular corner of her cage, place the nest box in a different corner.

Other equipment

Cleaning and disinfecting equipment
Propane torch (to burn accumulated hair from cages)



Figure 18 Wire-bottomed nest box

Carrying cages
Scale
Shovels and a wheelbarrow
Tattoo kit
Table or workbench
Assorted hand tools for maintenance and repair
Feed measures
Fire extinguisher(s)
Record cards
Nail clippers

RABBIT NUTRITION

Digestive system of the rabbit

Like all monogastric (single-stomached) animals, the rabbit's digestive tract consists of a mouth, esophagus, stomach, small intestine, cecum, colon and rectum. The rabbit has a very large cecum and this organ is very important to its digestion.

Like the first stomach of a ruminant, the cecum is where microbial fermentation of fiber occurs. The cecum of the rabbit is located so far along the digestive tract that to benefit from microbial action there, the rabbit must reingest the feces directly from the anus. Eating the soft feces is called coprophagy. Generally it takes place at night.

It is estimated that 25-30% of the feces are soft pellets from the cecum, and almost all of them are reingested, making it possible for the rabbit to benefit from the vitamins (especially the B complex vitamins) synthesized in the cecum. These night feces are also a source of crude protein and some minerals.

Coprophagy starts at about the age of 20 days. This coincides with the time the young leave the nest box and begin to consume solid food. At this age, the cecum increases in size

considerably. Coprophagy is essential in the digestive process of rabbits, enabling them to get the greatest amount of nutritional benefit from the food they consume.

Nutritional requirements

Not a great deal is known about the nutritional requirements of rabbits, although studies are under way.

The nutrients known to be essential to rabbits can be grouped into five categories. There are varied opinions as to the actual amounts of each nutrient required.

Energy Rabbits' energy requirements have not been fully determined. It is known that as the dietary requirement for energy increases, feed intake will increase. Primary sources of energy are carbohydrates and fats. Some energy also comes from the breakdown of protein when more protein is eaten than the body requires.

In most diets, soluble and fibrous carbohydrates are the most important sources of energy. Starch (a soluble carbohydrate) is found in large amounts in cereal grains (oats, barley, wheat, corn). Fibrous carbohydrates (found in forages) are important to rabbits because their long digestive tract enables them to make use of fibrous feeds. Some fermentation of fiber takes place within the cecum and this,

plus coprophagy, makes the nutrients in the fiber available to the rabbits. Although the digestibility of crude fiber by rabbits is relatively low, 12-14% seems essential for rabbits to maintain intestinal condition.

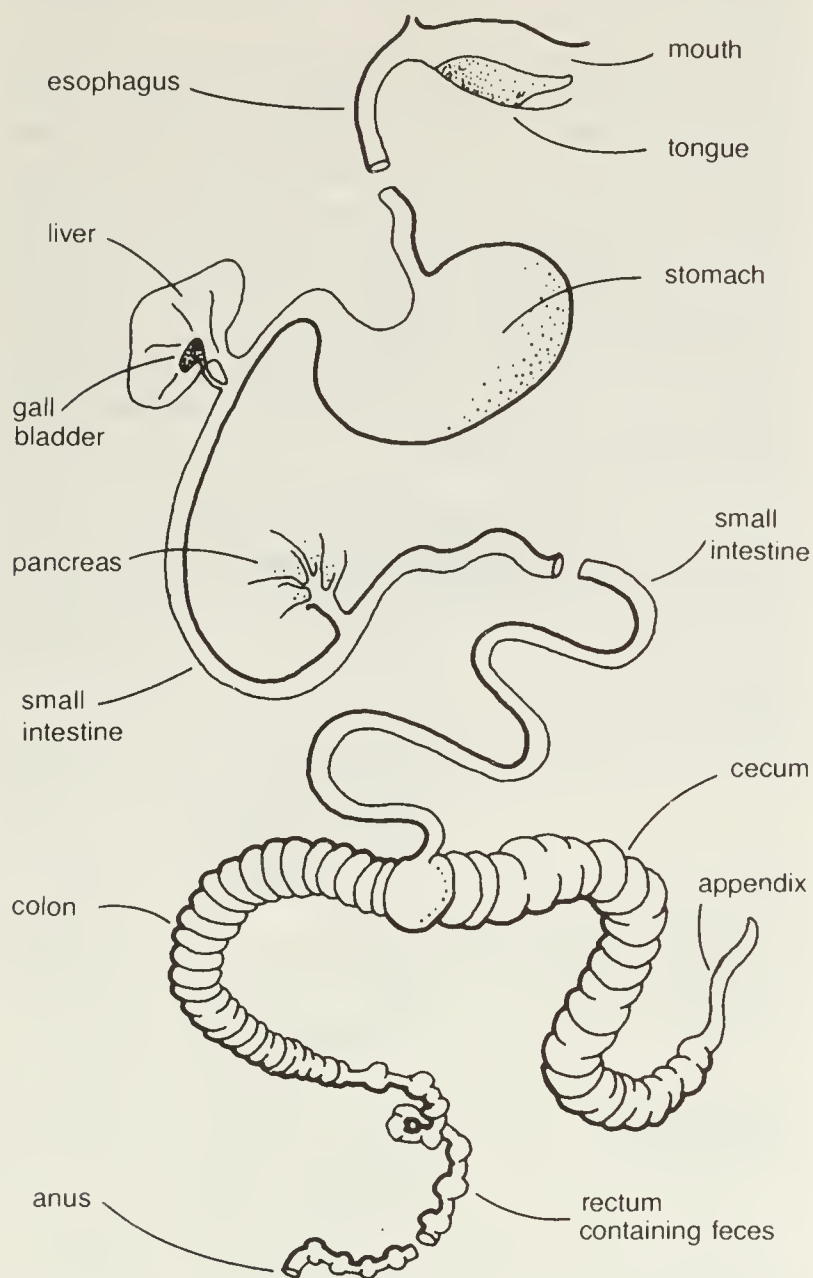

Figure 19 Digestive tract of the rabbit

Fat is a concentrated form of energy that contains more than twice the digestible energy of carbohydrates and protein. Specific requirements for fat have not been established for rabbits. Most commercial rations contain 2-3% fat but rabbits might benefit from more.

Protein Protein is one of the most important and most expensive nutrients in the rabbit diet. It is required for growth and the production of body tissue. Protein is made up of sub-units known as amino acids. There is still a great deal of controversy as to which and how much of the 20 naturally occurring amino acids are required by rabbits.

Protein is obtained from legume hays (alfalfa, clover) linseed meal, soybean meal, wheat bran, cereals and pasture grasses. The United States National Research Council (NRC) recommends that rabbit rations contain 16% crude protein during growth, 12% for maintenance, 15% during gestation and 17% during lactation.

Minerals A number of inorganic elements are required for normal functioning. Calcium and phosphorus are required in relatively large amounts for growth, reproduction

and lactation. Sources of these minerals are bonemeal, legume hays, green forage and cereals grains. (NOTE: Excess calcium is excreted by rabbits in their urine in the form of calcium carbonate, which causes the urine to become thick, white and creamy. This condition is not harmful.)

Sodium chloride and potassium are required to maintain body pH (acid-base balance) and control the water level in the tissues. Salt is a chief source.

Trace elements (i.e., those required in minute amounts) include iron, copper, magnesium, iodine, manganese, zinc, cobalt, selenium and sulphur. Each serves a specific function within the body and is usually obtained in the regular diet.

Vitamins The vitamins are a group of nutrients which help regulate growth processes, assist in digestion and help prevent disease.

Vitamin A promotes health and growth. It is found in green grass, carrots, milk, well-cured legume hay, yellow corn and cod liver oil. It is generally added to the diet in a synthetic form to ensure potency.

The requirements for Vitamin B complex are partially satisfied by the bacterial action in the cecum. Coprophagy makes these vitamins available to the rabbit.

No dietary requirements for Vitamin C have been determined.

The amount of Vitamin D required is not known, but a complete lack of this vitamin in the diet causes rickets. Good sources are milk, grasses, greens and well-cured hays as well as synthetic forms.

Vitamin E is essential for growth, gestation and lactation. Indications are that Vitamin K is required for normal reproduction but not for growth.

Water Water is perhaps the most essential element of the diet because all vital body processes depend on it. Without water, a rabbit will die. A restricted water supply will decrease the amount of food it consumes (and thus its growth rate), reduce the milk supply of nursing does and may cause the rabbit to develop digestive disorders.

An adult New Zealand White rabbit drinks about 280 mL of water daily; a doe near kindling may consume twice that amount. In hot weather a lactating doe together with a large litter approaching weaning may consume a total of 4.5 L of water daily. Under heat stress, water intake will increase drastically. Rabbits will also drink more water than normal during cold weather because they are likely consuming more feed. It is essential that a good supply of clean, fresh water be available at all times.

Feedstuffs

Rabbits can consume many different kinds of feed. Your choice of feedstuffs is determined by availability, cost and quality.

Forages Given a choice, rabbits prefer legume hays such as alfalfa and clover above other hays. Grass hays such as timothy are less palatable and may contain only half the protein of legume hays. Rabbits seem to use the protein in alfalfa very efficiently. The fiber it contains, though indi-

gestible, helps the rabbit maintain growth by keeping the intestinal wall healthy. This fiber may also be responsible for protecting the rabbit from the invasion of organisms responsible for mucoid enteritis. (See section on Diseases and abnormalities.)

Alfalfa is one of the richest sources of vitamin A and calcium. A mixture of 80% grain and 20% alfalfa meets the calcium and phosphorus needs of a growing rabbit. It is estimated that diets containing 20% alfalfa yield the best growth rates and offer protection from enteritis.

There are arguments both for and against using hay to supplement pellet feeding. Those who feed hay to their rabbits argue that the hay provides an additional source of crude fiber that may be lacking in commercial pellets. They also maintain that hay helps cushion young rabbits against digestive upsets and adds bulk to their diet. Others argue that feeding hay in addition to pellets creates extra labor and mess. They also argue that hay of poor quality may throw the ration out of balance and create deficiencies. There is also the possibility of the hay being contaminated by other animals. In any event, all hay fed to rabbits should be of good quality, dry and free from mold and noxious weeds.

Grains Rabbits prefer wheat and barley to corn. Despite the high energy value of corn, rabbits do not perform as well on this food as they do on other cereal grains. In contrast, oats give a better response than would be predicted from its lower energy content. Rabbits may prefer fibrous grains such as oats because of their palatability. Buckwheat, rye, flax and sunflower grains have also been used as energy feeds.

To prevent waste and encourage digestion, grains should be rolled, cracked or ground before feeding. Milled wheat products and by-products from manufacturing foods from other grains may also be fed. Rabbits do not usually chew whole grains sufficiently to receive full nutritional benefits from them.

Protein feeds Soybean meal has been used as a protein source for many years. Canola meal can also be used.

Greens Green feeds are not generally used by commercial producers because growth rates are diminished and labor requirements are high. Greens, however, may be considered by backyard or small-scale rabbit producers who wish to reduce their purchases of commercial pellets and who have the time and labor available.

If greens are used, they should be fresh and fed regularly, e.g., late every morning. Greens obtained from green grocers or market gardeners should be thoroughly washed to remove chemical pesticides. All uneaten greens should be removed from the cages daily.

Studies show that rabbits become more selective in their choice of greens as their supply of commercial pellets increases.² Red clover leaves and flowers seem to be the favorite greens. Nevertheless, you should attempt to provide a variety. Some plants such as cabbage can cause goiter if fed in large quantities for a prolonged period. Root crops such as carrots, turnips and beets can be fed in winter when fresh greens are unavailable.

Methods of feeding

The caged rabbit cannot forage and select its diet as its wild counterparts do. The domestic rabbit is totally dependent upon you to provide balanced rations in satisfactory amounts.

Home mixed rations If you decide to feed grains and hay, you must consider the cost, availability of feedstuffs, mixing equipment and the storage space required. Rations must include salt, supplementary protein, a mineral supplement and vitamins. If you mix your own rabbit rations, you will find it is best utilized when properly mixed and fresh. Rations can be fed as a single diet or with the forages kept separate from the feed mixture.

If you are feeding home-mixed rations, you must experiment with the amounts to be fed to rabbits in various stages of growth and development.

Suggested ingredients for different rations

	Ingredients	% of rations
For growing rabbits (0.5-4 kg)	Alfalfa hay	50
	Oats	17
	Barley	22
	Wheat bran	5
	Soybean meal	5
	Iodized salt, minerals and vitamins	<u>1</u>
		100
For maintaining does and bucks (average weight 4.5 kg)	Legume hay	70
	Oats	29
	Salt and micro mix	<u>1</u>
		100
For pregnant does (4.5 kg average)	Alfalfa hay	50
	Oats	45
	Soybean meal	4
	Salt and micro mix	<u>1</u>
		100
For lactating does (4.5 kg average)	Alfalfa hay	40
	Wheat	25
	Barley or oats	22
	Soybean meal	12
	Salt and micro mix	<u>1</u>
		100

These rations are similar to those recommended by the U.S. NRC in 1977. The micro mix should include enough minerals and vitamins to complement those analyzed in the grain, forage and protein meal.

For maximum growth of fryers, feed should be provided free choice (i.e., constantly available) but not wastefully. Pregnant does can be fed in the same way, but they must be watched closely so that they do not become overweight. A week before a doe (especially a young one) kindles, reduce her feed to 60-110 g/day. Bucks and does being maintained should be kept lean by feeding them approximately 70 g of home-mixed rations, plus free-choice hay. Lactating does will likely require 85-140 g of the ration plus free-choice hay daily.

Commercial feeds Most raisers buy rations from a commercial feed mill because of the availability of the product, the ease of handling and the reduced storage requirements.

Commercially prepared feeds cost more but this is offset by savings in labor. They are usually general purpose diets; however, no two commercial feeds have the same contents, so you must evaluate each ration against your herd requirements before making a selection. Some feeds sold as “incomplete” feeds must be supplemented with alfalfa hay. The incomplete feeds are generally all-grain pellets consisting of cereal grains, their milled by-products, protein supplements and salt. “Complete” feeds include good quality ground hay in the pellets.

Pellets should be 0.5 cm in diameter and about 12 mm long; if they are too long there will be considerable waste by young rabbits. They must be hard enough to avoid being crushed under normal conditions of storage and handling. A high proportion of alfalfa tends to produce soft pellets with large amounts of fine material.

The quantity of commercial pellets depends in part on the quality of the feed. Commercial pellets vary in protein content depending on their intended use: 12-15% (protein content) pellets are available for maintaining does and bucks; 16-20% pellets are available for gestation, lactation and growth.

The composition of pelletized rations varies as can be seen in the analysis of ingredients of two commercial feeds. The first, Feed A, is a high-energy/low-fiber feed; the second, Feed B, is low energy/high fiber.

	Ingredients	% of ration
Feed A	Barley	25.00
	Oats	20.00
	Dehydrated alfalfa	25.00
	Beet pulp	5.00
	Soya meal	17.50
	Tallow	0.50
	Lignosal (binder)	0.70
	IMC DiCal phosphate 18-20	2.00
	Calcium carbonate	1.00
	Salt	0.30
	Premix 5	0.50
	Molasses	2.50
Feed B	Sun-cured alfalfa meal	52.90
	Soya meal	20.60
	Wheat mill run	19.60
	Trace mineral salt	0.49
	Dicalcium phosphate	0.25
	Molasses	2.96
	Tallow	1.20
Bentonite (binder)	2.00	

You can use a different feed for each stage in a rabbit's development with the amount fed remaining relatively constant. Or you may choose to limit the number of rations to one feed and vary the amounts fed to the rabbits according to their stage of development and physiological state.

Rabbit feeding program (Suggested daily portions)

Bucks	85-112 g
Resting does	85-112 g
Pregnant does (increase gradually throughout pregnancy)	168-224 g
Lactating does	up to 454 g
Fryers	all they want

Whatever kind of ration (commercial pellets or home mixed) is fed, the actual amount required depends on the individual rabbit. Too much for one rabbit may not be enough for another. When determining the amounts of feed required for optimum growth, you must carefully weigh the feed and keep records of consumption and rates of growth. Feeding either too much or too little can be very costly: feed is one of the largest expenses in any rabbit-raising operation. Good feed control is a sign of good management.

Medicated feeds

Some breeders give their herds medicated feed on a continuous basis in an attempt to reduce disease (such as coccidiosis). Other than treating rabbits for a specific ailment in times of need, the long-term, indiscriminate use of medication in feeds is not advisable, for the rabbits may become resistant to the drug. Animals intended for human consumption should be withdrawn from all medication for a minimum of 5 days before slaughter or according to the manufacturer's directions. Specific disease may be treated with medication administered in feed or water, or by injection. (See section on Management.)

Feed storage

Feed should be stored in a separate area from the rabbits. It must remain cool, dry and free from vermin. Pelletized feed stored in paper sacks remains clean until the time of use. Storage bins are susceptible to bacterial growth if not cleaned regularly. If hay is used, it is best stored in a protected location so that it does not deteriorate in nutritive value. Feed should be used while fresh and in good condition. Storing hay indoors lessens infestation by pests and offers protection from cats and dogs who can infect the hay with tapeworm cysts.

Nutrition and disease

A carefully balanced diet is essential for rabbits subjected to the conditions of intensive production. Rabbits pushed to fryer weight too quickly may suffer from enteritis caused by carbohydrate overload. This happens when a high level of energy from soluble carbohydrate sources is fed in the diet. Excessive quantities of starch reach the cecum and the colon, allowing rapid proliferation of bacteria. This rapid build-up in numbers of pathogenic bacteria leads to enteritis. Diets high in grain and low in fiber promote an increased incidence of enteritis, while diets containing no grain have produced no enteritis in studies to date.³

Particle size of the feed may also be important. Larger particles are moved rapidly through the digestive system while smaller particles are retained. This retention could stimulate bacterial growth leading to enteritis.

If the rabbit is not capable of handling high-energy diets, then its growth rate is limited. Low-energy, high-fiber diets reduce the growth rate and increase the feed conversion ratio, both factors that may lower profitability. Improving the growth rate by increasing the carbohydrate level in the diet may increase the risk of losses due to enteritis. Some compromise may be necessary. For example, you might find it more efficient in the long run to feed fryers longer using more low-energy feed than to push them with a high-energy diet and suffer losses from enteritis.

Perhaps 50% of all known rabbit diseases may be affected by nutrition. Even when bacteria or viruses cause the disease, nutrition may be a major factor contributing to the length and severity of the illness.

There are a number of well-known nutritional deficiency diseases. For example, a deficiency in vitamin E is known to cause muscular dystrophy. Most vitamins used in commercial feeds are synthetic rather than natural, and sometimes they are added in insufficient amounts. Furthermore, synthetic vitamin E can be destroyed by the heat of the pelletizing process. The quality of the alfalfa used in the pellets can vary as well. Despite these potential drawbacks, it is still more efficient to buy commercial feed than to attempt to

make it on a small scale. You must choose the best rations available and treat that feed as the basis for production. With good management practices, you should meet with success.

Changing rations

The rabbit's digestive system, though able to handle a wide variety of feedstuffs, is sensitive to change in diet. This is most evident when you change commercial rations. Problems may also be encountered when a new batch of pellets of your regular brand is introduced.

Feeds may differ significantly in content although they contain the necessary nutrients. Economic conditions frequently govern the ingredients used in rations. Changes from one year's crop to the next and the conditions at the feed mill at the time the feed was prepared affect the composition of the ration. The quality of one batch of feed will, for the most part, be consistent with that of another, but the ingredients may vary. To help the rabbits make the transition from one feed or batch to another without stress, indigestion or setbacks in growth, you should mix both lots together, gradually decreasing the proportion of the old feed as the amount of new feed is increased.

REPRODUCTION

Fertility

Rabbits usually breed throughout the year, though there may be a seasonal winter depression. The doe remains fertile for long periods. If she is not bred, the egg follicles in the ovary remain large and healthy for a period of 12-16 days, after which they atrophy. Meanwhile, new follicles grow to replace them. This means active follicles are present nearly all the time. Sometimes there is a transitional period, when the new set of follicles is growing and the old set is diminishing, when the does may be temporarily sterile. However, because you cannot determine the exact stage of follicle growth, it is best to presume that the doe is fertile at all times.

Does are induced ovulators; ovulation (the process of shedding eggs) only occurs following sexual stimulation. After mating, the follicles in the ovary begin to grow rapidly. They break and release the eggs about 10 hours later. During this time, the sperm are moving through the female reproductive tract to the upper part of the fallopian tubes, where they fertilize the eggs. The fertilized eggs then grow into fetuses which develop in the uterine horns.

Gestation period

The gestation period (from mating to giving birth) is 31-32 days. Young may be born earlier or later than this. However, if kindling is delayed 2 or 3 days, the reason may be that one or more of the fetuses is unusually large.

Breeding age

The proper age of bucks and does for mating depends on both breed and individual development. Smaller breeds develop faster and are sexually mature sooner. Females

generally mature earlier than males.

Often a doe will show signs of receptivity at 3 months of age, but she has not yet reached the size or the condition to handle the stress of pregnancy. Very young mothers often do not care for their young.

Most breeds of commercial rabbits are first bred at 4-5 months of age. With time, you will recognize optimum age to begin mating your rabbits. The age to begin mating is crucial. The doe must be bred before she accumulates internal fat because once it develops, it is very difficult to eliminate. Rabbits are meant to have very little fat and it is easy to overfeed them. Once fat collects around the reproductive organs, does become reluctant to breed. This is why does must be bred as soon as they are mature enough.

Before mating, inspect the bucks and does thoroughly for health, fitness and maturity. The mature buck should be well developed, fit but not fat, bright of eye, with good appetite and energetic. Both testicles should be completely descended into the scrotum, and the scrotum should be full and large. If one testicle has not yet descended, the condition may be temporary. In this case, do not use the buck but observe his development. A buck with withered or wrinkled-looking testicles may be temporarily or permanently sterile.

A mature doe should also be in good condition with a shine to her coat and bright eyes. A doe in the peak of mating condition will raise her tail if she is stroked across the back and shoulders. Another sign a doe is receptive is her vulva will be congested and reddish to purplish. She may show signs of restlessness or nervousness and a desire to be with other rabbits. She may rub her chin frequently on the cage or utensils. These are just indications; the only way to be sure is to place the doe with the buck and observe the reaction.

Mating

The best times for mating are early morning and late evening, particularly in hot weather when rabbits are reluctant to breed. It is also advisable to mate before feeding for hungry rabbits are more alert than are full-stomached ones. It is vitally important that the matings take place in a calm, quiet atmosphere without rush or rough handling.

A doe should always be taken to a buck's cage for service. She tends to be territorial, and will often attack and injure a buck placed in her cage. Furthermore, if a buck is put into a doe's cage, his first instinct is to check for the scent of other bucks. If none is found, his second instinct is to mark the territory with his musk which is produced in two glands beneath his chin. Only then will he feel comfortable with the mating ritual.

Natural mating Of the four mating methods natural mating is the best and has the highest conception rate. The doe should be placed in the buck's cage with her back to him. This way he can mount her quickly and accurately, saving her from stress and him from frustration. A receptive doe will raise her hindquarters and throw up her tail to permit entry by the buck. Upon contact, the buck ejaculates almost immediately. The act may be accompanied by a cry from either animal. After mating, the buck usually falls over on his back or side. An experienced rabbit raiser can check the vulva of the doe to see if penetration actually took place. This can prevent guesswork and missed breedings.

Immediately after mating, the doe should be removed from the buck's cage and carried, vent upwards to retain the semen, back to her own pen. Reluctant does may be successfully mated if they are returned to the buck's cage within 6 hours following the first attempt at mating.

Forced mating If the doe will not accept service, she can be restrained. This method can be helpful in mating rabbits for the first time. Generally, an experienced buck will be more successful in mating a maiden doe.

To restrain a doe, face her and hold her ears and the skin on her shoulders with one hand. Put your other hand under her body and between her hind legs. Place your thumb and index finger on either side of the vulva, gently pushing the skin backward. This throws the doe's tail up over her back. Support her weight and elevate her hindquarters. The buck will mount the doe, as she is now in a receptive position. Rabbits accustomed to being handled will not object to this assistance.

Confined mating Another method of mating an uncooperative doe is to leave her with a buck for a few hours or overnight, so she will become used to him and receptive. The major drawback to confined mating is, unless you see the actual mating, there is no guarantee it has taken place. The rabbits may also fight and injure each other.

Artificial insemination Artificial insemination has been used with rabbits, but not to any great extent. It is doubtful that artificial insemination will ever replace natural mating as it is too expensive and time consuming for the small operator. You are better off choosing breeding stock with high sex drives and a willingness to mate naturally.

Determining pregnancy

Determining pregnancy by test mating (i.e., placing the doe with the buck to see if she will again accept service) is not the most reliable method. Some pregnant does will accept the buck, and some nonpregnant ones will not. Another method is palpation, but it requires an experienced teacher and many years of practice to develop the skill to do it safely.

Palpation is feeling the abdomen of the doe for fetuses in the uterus. It is performed 10-14 days after mating. At this stage, the fetuses have developed into chains of marble-shaped forms on either side of the midline of the abdomen. As the fetuses grow they rise into the abdominal cavity and may be mistaken for internal organs, while earlier in the pregnancy fecal pellets may be mistaken for embryos.

Does may be palpated in their cages or on a nonslip surface at a convenient height. Calm does, used to being handled, are the easiest to palpate.



Figure 20 Palpation

Stretch the doe out on the table facing you. Restrain her by grasping her ears and a fold of skin above the shoulders with one hand. Place the other hand under the body between the hind legs and slightly in front of the pelvis. Put your thumb and forefinger on either side of the uterine horn. You should be able to distinguish the fetuses as chains of grape-shaped forms that slip easily between the thumb and fingers. Gentle handling is required! If too much pressure is used, the doe may abort. At first, palpate on day 14, beginning with an experienced doe and an experienced teacher. Eventually, the date of palpation may be brought forward to as early as day 10.

BREEDING PROBLEMS

It is commonly believed that rabbits "breed like rabbits". As a result of this assumption, it is easy to envision a myriad of offspring produced by one adult pair. But what a pair of adult rabbits can produce in theory is often not true in practice, for a number of conditions can inhibit conception.

Pseudopregnancy

Sometimes a doe seems to be pregnant, even to the point of producing milk and making a nest, and yet she is not pregnant. A false pregnancy may be caused by infertile mating or sexual stimulation when one doe rides or is ridden by another. Following stimulation, the doe releases egg cells, causing the uterus to increase in size in preparation for accommodating the fertilized eggs and activating the mammary glands. Ovulation cannot take place until the hormone secretion has dissipated: 17 days following the stimulation which caused the pseudopregnancy.

The doe may indicate the end of pseudopregnancy by pulling fur and attempting to make a nest. She will, however, make no attempt to keep the nest clean. Palpation will confirm that she is not pregnant. The doe should readily accept the buck at this time, and the union should result in true pregnancy because her fertility will be at its highest point at the end of the pseudopregnancy.

To prevent pseudopregnancy, separate young does that are to be mated 3 weeks before mating. Once a doe has reared her first litter, she is less likely to undergo pseudopregnancy if she is kept active by an early remating program.

Sterility

There are times when rabbits will show no interest in breeding, or show signs of sterility. Sterility is a condition in which either sex is incapable of reproduction, either temporarily or permanently. A number of causes limit conception in rabbits.

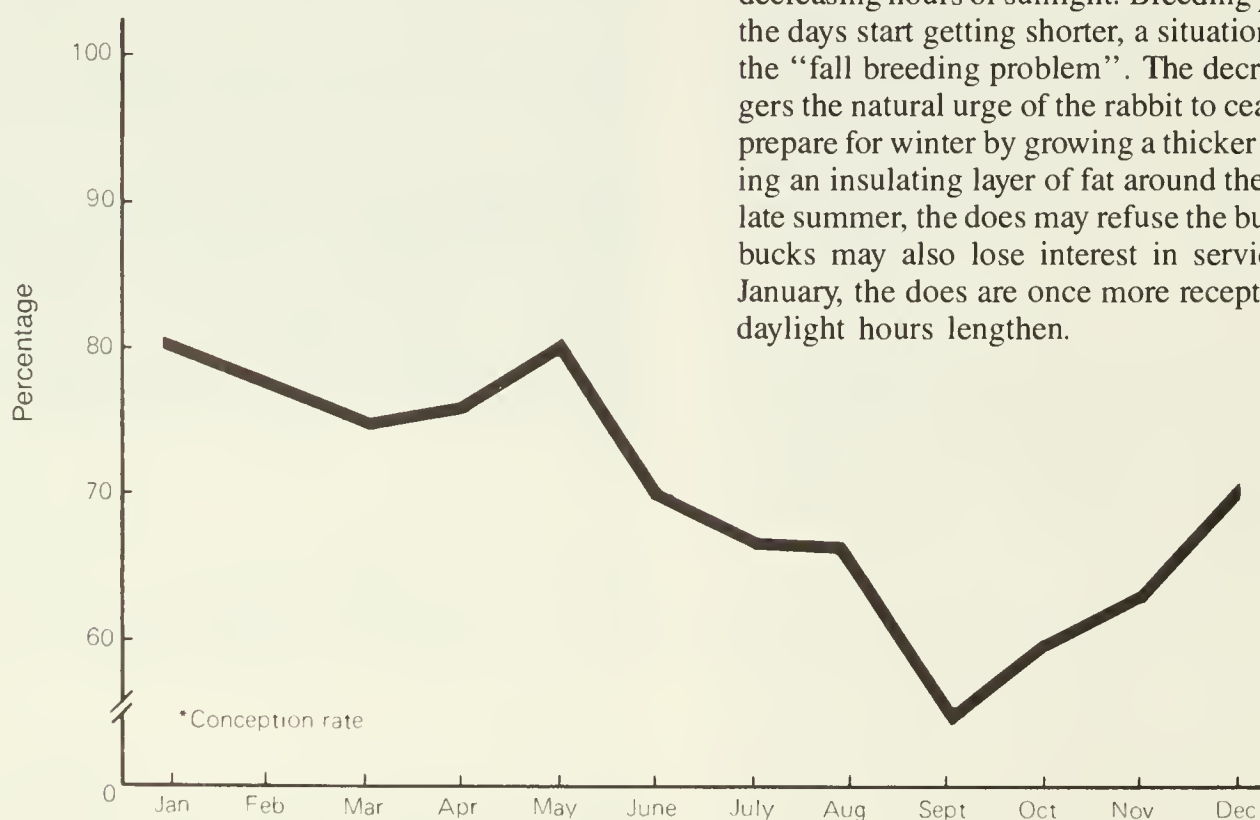

Figure 21 Seasonal changes in reproductive capacity⁴

Physical condition Obesity is likely the major cause of breeding problems. Overweight rabbits tend to be lazy and not interested in breeding. An overweight doe may not always show signs of fat, for much of it is accumulated internally around the reproductive organs. Once a doe is in this condition, she is very difficult to breed. Similarly, overweight bucks may be lazy breeders.

It is easy to overfeed your stock, particularly when they seem hungrier with the approach of winter. To prevent this, you should weigh your animals regularly to ensure they maintain a constant weight. Breeding the does as soon as they are sexually mature and keeping them in production by remating them before their litters are weaned will keep them lean and fit.

Nutritional deficiencies Any rabbit that is underfed or given a diet that is nutritionally inadequate may be incapable of reproduction. Most commercially prepared rabbit feeds contain adequate amounts of the necessary vitamins and minerals.

Summer heat Breeding problems always increase in the fall and winter months, usually from September to mid or late January. One factor is the summer heat. Bucks can become sterile in extremely hot weather. The length of time sterility lasts is directly proportional to the length of exposure. This condition affects adult males more than maturing ones (5-7 months of age). When the temperature exceeds 29°C for several consecutive days, male rabbits remain sexually active but may not be fertile for about 60 days.

To prevent heat-caused sterility, you should keep the temperature of the rabbitry below 24°C and have young males available to replace older ones when they suffer from heat stress. Keep a daily temperature chart for the rabbitry and avoid extreme temperature fluctuations. When cool weather returns, mature bucks may be returned to service after a 2-month rest.

Decreasing daylight Does are particularly affected by decreasing hours of sunlight. Breeding problems increase as the days start getting shorter, a situation often referred to as the "fall breeding problem". The decreasing daylight triggers the natural urge of the rabbit to cease reproduction and prepare for winter by growing a thicker coat and accumulating an insulating layer of fat around the internal organs. By late summer, the does may refuse the bucks entirely, and the bucks may also lose interest in servicing them. By mid January, the does are once more receptive to service as the daylight hours lengthen.

The problems of early winter slowdown can be alleviated somewhat by extending the rabbit's "day" with artificial light. The amount required will depend upon the latitude at which the rabbitry is located. The artificially lighted day should be no longer than the longest day of the year. It should be added in both the morning and the evening, balancing the natural decrease in daylight. The fall breeding problem can also be overcome if you bring the herd into the fall months in a state of intense productivity. Hormone levels are higher in producing does, and mating and conception rates are correspondingly higher when rabbits are kept in production.

Inherited factors Some rabbits are better breeders than others. The tendency to a fall breeding slump or a low-fertility rate may be inherited. Try to select animals that have hereditary traits for mating and conceiving readily the year round. Sluggish breeders should be culled.

Molt In the wild, rabbits go through a summer molt (shedding of hair) that heralds the beginning of the barren period. Domesticated rabbits also go through a molt of varying intensity which can affect their breeding capacity.

Stress Stress is nervousness brought on by fright, exhaustion, injury, sudden temperature changes, etc., that can affect breeding at any time. Some rabbits are easily disturbed while others are not. Stress can be reduced in part by

selection and by good management techniques. (See section on Diseases and abnormalities.)

Age Young does may not be sexually mature at the time of service, while old does may have passed their prime. Does should reproduce satisfactorily and successfully nurse their litters if they are in good condition. In commercial herds, does that are properly cared for should produce about 15 litters. An exceptional rabbit may surpass that number.

Diseases and abnormalities Poor health or abnormalities like the malformation or absence of any of the reproductive organs e.g., undescended testicles, can affect reproduction (See section on Diseases and abnormalities).

Neonatal deaths and abortions

Premature and term stillbirths are caused mostly by disease and poor nutrition. The doe may kindle at an early date and show no further interest in her young, allowing them to die from neglect. She herself may show signs of stress and die suddenly. Treat pregnant does gently. Don't make excessive noise or sudden movements which might distress them.

Sometimes a large bunny will get stuck in the birth canal and will suffocate. If it is stuck for any length of time, those remaining in the uterus will also suffocate and will be stillborn.

RAISING THE LITTER

Kindling

Kindling (giving birth) is a critical time so it is important the doe is comfortable and prepared with proper nesting material before the delivery of her young. Most does kindle at night and they resent interference.

A nest box should be placed in the doe's cage 27-28 days after she has been bred. The nest box should contain an absorbent, dust-free bedding material such as wood shavings or straw. Many pregnant does will grab some bedding in their mouths and run around the cage with it before settling down to make a nest. If a doe urinates in the nest box, however, she may not be pregnant after all.

The day before the doe kindles she may refuse to eat but will drink freely. Just before the young are born, she will complete her nest with a layer of hair which she pulls from her belly. The bunnies are born blind, deaf and almost furless. The doe will clean them and cover them with more fur from her abdomen. She will be nervous after kindling and should not be disturbed until she settles down.

Care of the young litter

As soon as possible following kindling, you should quickly and quietly check the cage for babies left outside the nest. Young does may kindle on the wire or fail to pull fur to cover the newborn in the nest. If discovered in time, the young may be saved by warming them and placing them in the nest covered with fur which you can pull yourself from the

underside of the doe. Some breeders save extra fur from summer nests for supplementing the amount of fur required in colder months. A good doe, however, will provide adequate covering herself.



Figure 22 Litter in nest box

During this first inspection you should make a careful count for the record book. Litters may vary greatly, from as few as one to as many as 15.

Daily litter inspection is extremely important. The litter should be checked for injuries and deaths and counted to be sure that one or more have not become separated from the nest. They should be quiet with round full bellies. Squirming active young in the first 2 weeks of life may not be

receiving adequate nourishment. Reducing the litter number by fostering may result in better-fed young.

During cold weather, check the nest to ensure that the young are adequately covered. Occasionally, the doe will jump out of the nest box with a baby still attached to a teat and not return it to the nest herself. If you discover one out of the nest and it appears dead, it may only be stiff with cold and can be revived. One of the surest methods for warming a baby that is unconscious with cold is to place it under your armpit until it is revived.

Young rabbits in nest boxes are also very susceptible to extreme heat, and such discomfort is characterized by restlessness. You can remove the fur covering from the nest box in the mornings and replace it at night. During hot weather, young that have begun to grow hair can be removed from the nest boxes and placed on the wire of the cage floor until it is cool enough to return them. A water-soaked sack spread over the cage above the nest box may also have a cooling effect.

Young rabbits usually open their eyes 10 days after birth. In some instances, the eyes remain closed because of infection, usually caused by dusty bedding. If the eyelids are inflamed and encrusted, bathe them with a 4% solution of boric acid applied with a clean cotton swab. When the tissues are softened, the lids can be separated with a bit of pressure. Once the eyelids are open, healing is rapid and any subsequent treatment is usually unnecessary.

Fostering

Most rabbit raisers will breed several does at the same time to ensure that more than one will kindle at a time. If one doe has a very small litter (e.g., two or three young), her young can be transferred to the nest of another doe whose young are of the same age. The first doe can then be rebred immediately. If a doe dies shortly after giving birth, her young can be fostered by other does, provided that the young of the foster mothers are no more than 48 hours older than those being fostered.

Some breeders foster rabbits from one healthy doe to another regularly to even out the sizes of the litters. For example, a doe producing six live young may be given two more from a doe that produced ten. The decision to foster will depend upon the mothering ability and the milk supply of the recipient doe.

A doe may reject the young of another doe and refuse to enter her own nest box following the addition of new bunnies. If she seems nervous about the additional young, you can put some vanilla extract on her nose. By the time the smell has worn off, the new babies will have picked up the scent of the nest box and will be accepted by the doe as her own.

If you plan to save some of the fostered young as breeding stock, they must be marked for identification. A drop of tattoo ink applied under the skin of the ear with a hypodermic syringe is a good method of identification.

Causes of death among newborns

About 20% of losses occur during the first 8 weeks of life. Half of those losses occur during the first week of life, and have a variety of causes.

Chilling If a doe is disturbed — by loud noises, bright light, strangers or predators — she may kindle on the cage floor, and the young may die from exposure. Low building temperature, drafts, poor nest boxes or inadequate nesting material may also cause death from exposure.

Injury If the doe is disturbed after the young are born, she may jump in and out of the nest box, or stomp in the nest with her hind feet, which could kill or injure the newborn.

Cannibalism Does, especially those producing their first litter, sometimes eat their young. Cannibalism can be caused by a lack of water for the doe prior to kindling, fear, or accidentally nibbling the limbs of the young during birth. Diet deficiencies, particularly calcium deficiencies during periods of high milk production, may also cause it. Cannibalism may be an inherited tendency.

Does generally do not kill and eat healthy young, but limit their cannibalism to those stillborn or to those that have been injured and have died. Some rabbit raisers claim to have ended cannibalism by feeding potentially cannibalistic does a piece of bacon a day or two prior to kindling. Does that repeatedly eat their young should be culled from the herd.

Starvation A young nervous female may not settle in to nurse her litter. Starving babies will be thin and dehydrated and must be fostered within hours to be saved.

A sick doe may not nurse her young. Pregnancy is physically demanding and lowers vitality, increasing susceptibility to disease, for example, pneumonia. A sick doe must eat to keep up milk production and may be enticed with fresh greens. If she is not properly cared for, you risk losing both the doe and her young.

A doe with caked breast may refuse to nurse her young. Caked breast can result from injuries to the breast which block the milk flow. The breast becomes inflamed, hard and very tender. Rubbing lanolin on the teats may keep them soft enough to allow the young to nurse if the doe is restrained. The inflammation will be relieved if the milk flow can be maintained.

Mastitis or “blue breast” will also interrupt nursing. This condition is caused by bacterial infection and may be very contagious. The doe loses her appetite and becomes inactive. Her breast becomes congested and hot and turns dark red to purple; the teats are also discolored. Penicillin is an effective treatment; however, as mastitis often reoccurs, it might be best to cull the affected doe.

Lactation

The young rabbits remain in the nest box for about 2.5-3 weeks, during which time they rely solely upon their mother's milk for nourishment. The composition of the milk will vary from one rabbit to another, but it is extremely rich. It is essential for the rapid growth of the young rabbit. Rabbit milk contains more than twice the quantity of total solids as cow's milk, about four times as much protein and fat and three times as much ash, but only one-sixth as much lactose (milk sugar).⁵

It is obvious that the nursing doe must be fed properly if she is to supply adequate milk and maintain condition. It is important that a nutritional boost be given to the doe as soon

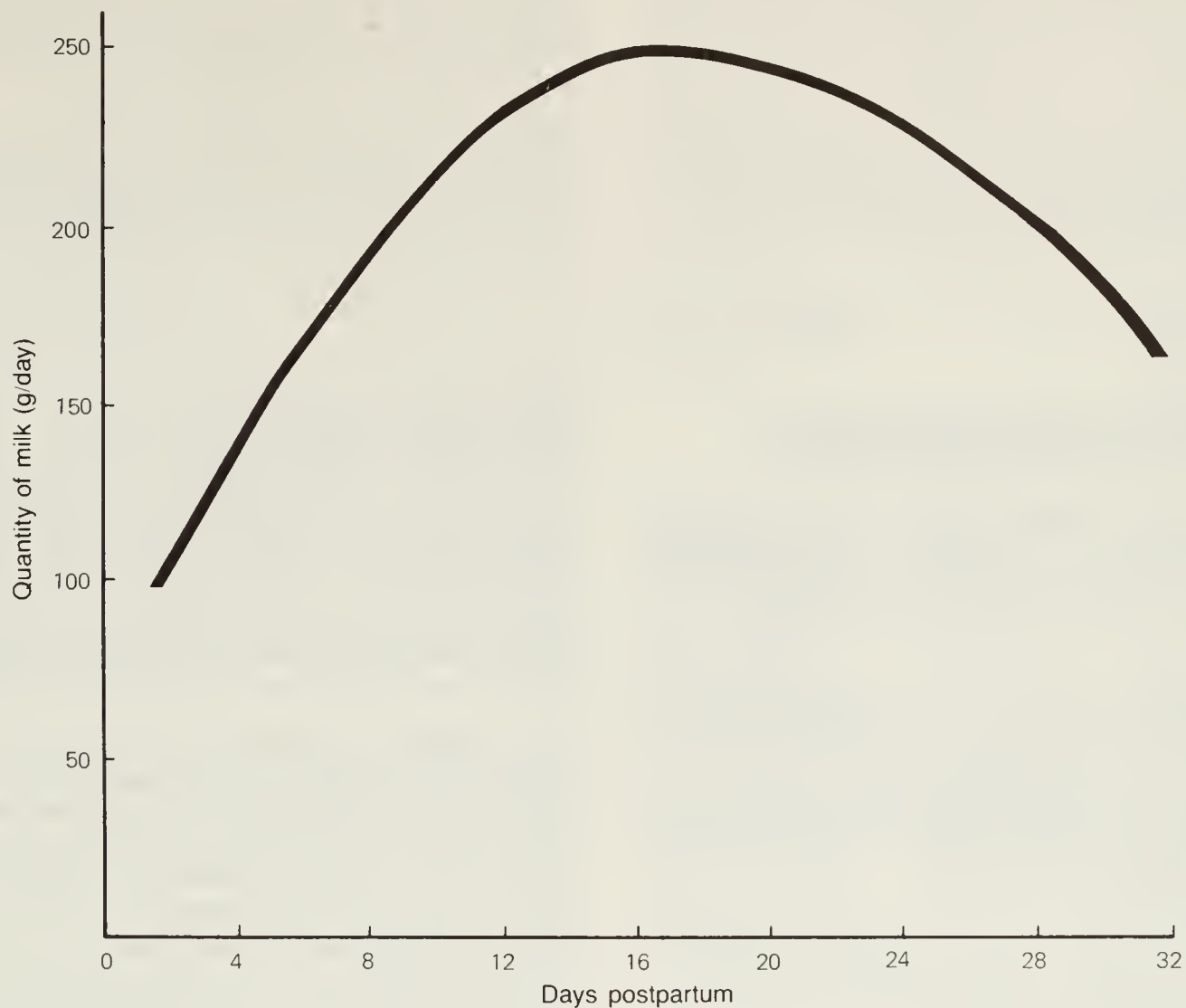

Figure 23 Milk production in does⁶

as her pregnancy is determined, for the growth of the mammary glands begins early in pregnancy. The most rapid growth of the fetus occurs during the last third of the pregnancy, so feed should be increased during the second half of the pregnancy (see section on Rabbit nutrition). By increasing feed during pregnancy, an improvement in post-kindling milk yield can be achieved.

The amount of milk produced varies throughout the lactation period, which usually lasts about 4-6 weeks. Maximum milk production is usually reached by the third week following kindling, after which it gradually declines.

The duration of lactation varies with diet, the number of suckling young and the length of time the young are left with the doe. The amount of milk produced depends upon the breed, strain, diet and genetic constitution, as well as the general condition of the doe, the mammary development and the demands of the litter.

It is imperative to determine the milk production of each doe. Weighing the young at 21 days when milk production is at its highest will give you an indication of the quantity and quality of the lactation of the mother. Prior to this check the young in the nest box to see that they are full-bellied and contented.

Does tend to nurse their nest-box young in a single feeding every 24 hours, usually at night or early morning. After the young leave the nest box and are consuming solid food, they will still try to nurse several times during the day. The doe will usually push them aside, however, and restrict their nursing to the night time.

Causes of death after 3 weeks of age

Losses may occur at about 3 weeks of age when the young begin to leave the nest box and eat solid food. From 3-10 weeks of age, the most common cause of death is diarrhea or rabbit dysentery. The diarrhea is a symptom of a disease, not a disease itself, and often appears at times of stress such as weaning. Even with treatment by antibiotics, up to half of the infected rabbits could die. Losses are usually highest among those with the lowest body weight. Coccidiosis may be the underlying cause, although bacterial infections, viral infections and low-fiber diets are also suspect.

Sometimes the deaths are epidemic in number which is extremely frustrating for the rabbit breeder. The maintenance of constant feed quality and a high standard of sanitation as well as the reduction of stress wherever possible are the best safeguards against losses. The nest box, which

harbors bacteria, should be removed from the cage 21 days after kindling. By this time, all the young should have left it on their own to seek solid food and to exercise their muscles.

Weaning

The easiest way to wean the young is to leave them with the doe for 8-10 weeks until they can be taken directly to market as fryers. However, this limits your number of breedings per

year.

Optimal weaning time will be determined by the breeding program followed. With accelerated breeding programs, it is advisable to wean the young in time to allow the doe a few days rest before the birth of her next litter.

Young rabbits undergo stress when separated from their mothers, no matter what their age. To minimize it, you should remove the doe to a new pen and leave the litter in their own familiar cage until they are marketed.

DISEASES AND ABNORMALITIES

If you have a well-managed operation, and keep a clean, properly ventilated barn, you should not have too many problems with disease. Nonetheless, it is useful to know the signs of health problems common among rabbits.

Stress

While stress is not a disease, it is a contributing factor to many health problems in rabbits. Stress is generally defined as a pressure or strain caused by an adverse force. It may come from sources inside the rabbitry or externally. Early signs of stress are difficult to detect in the individual rabbit and may have any number of causes.

Environmental Transporting your rabbits, changing their pens, overcrowding them or making other changes to their habitat can cause stress. Climatic changes: temperature, humidity, and drafts, are also factors.

Physiological Anything which upsets the function of the body such as pregnancy, kindling, lactation, changes in diet, as well as clinical causes like illness, injury or infection can cause stress.

Inherited Nervousness in reaction to noise, new handlers and strangers may be an inherited trait.

The effects of stress leave rabbits susceptible to disease. Young animals seem to tolerate and recover from stress better than older ones.

Diseases

Mucoid enteritis Enteritis or diarrhea is the number one killer of rabbits. It accounts for 50% of deaths from nest box to weaning in commercial rabbitries. The incidence of enteritis is very low until the fourth week of age; it peaks at 7 weeks and declines sharply after 8 weeks.⁷ It may also affect does just before or after kindling.

The causes of mucoid enteritis are unknown; both viruses and bacteria are suspected. Large outbreaks have occurred with sudden changes in feed or management, or from carbohydrate overload. Signs of the disease are depression, loss of appetite, rough coat, squinting eyes, grinding of the teeth, a hunched-up position, bloated stomach and diarrhea. The feces may contain large amounts of white, slimy mucous. The sick rabbit will be off in a corner by itself. As diarrhea and dehydration progress, the animal may lose 10-25% of its body weight in 24-48 hours.⁸ Death comes

rapidly and few animals can be saved.

Some feel that mucoid enteritis can be partially prevented by the addition of indigestible fiber — hay, clover, black-berry leaves, straw — to the diet to keep up the vitality of the intestinal lining.

There is no special treatment for rabbits with the disease. However, chlortetracyclines and oxytetracyclines added to food or water have been effective in reducing losses.

Pasteurellosis (snuffles) Another disease common among rabbits is snuffles. It seems to appear in almost every herd sooner or later. Signs of the disease are sneezing, wet forepaws (from rubbing the nose) and a mucous discharge from the nose which is sometimes covered with crusty scabs. The affected animals lose appetite and weight and become depressed and listless.

The disease is caused by a highly contagious bacterium which may also cause other diseases like septicemia, peritonitis and subcutaneous abscesses. Treatment is difficult and recurrence is common. Stress may also cause flare-ups. Antibiotics in the water or feed can help control outbreaks, but good ventilation and sanitation are required to prevent outbreaks from occurring. Ammonia buildup in a rabbitry from the accumulation of manure may also provide incubation for pasteurella organisms. Ammonia irritates membranes in a rabbit's nose, creating ideal conditions for bacteria to colonize.

If left unchecked, snuffles may spread to the lungs and cause pneumonia. Pneumonia is the greatest cause of death in mature animals. When medication fails to control the disease, it may be necessary to depopulate, clean and disinfect the rabbitry before introducing new healthy stock.

Raise pasteurella-free stock in a sterile environment. This is the best way to reduce pasteurellosis, for it seems once rabbits are infected, they remain susceptible to reinfection.

Coccidiosis Coccidiosis is the most common parasitic disease in domestic rabbits. It is caused by microscopic parasites that invade the liver and the lining of the intestine. Rabbits can tolerate mild infection but severe infection by these parasites causes illness.

Hepatic (liver) coccidiosis is usually not detectable in live rabbits. Affected animals may gain weight slowly. The parasites will appear as white spots in the livers of slaughtered animals.

Intestinal coccidiosis, which is more severe, causes weight loss despite a good appetite, occasional diarrhea that is

sometimes blood-tinged, and pot bellies. In more severe cases, progression of the disease is so rapid that the rabbits die before the handler realizes that they are ill. Fecal tests that can detect and diagnose the severity of coccidiosis are available from some laboratories.

Coccidiosis is transmitted from one rabbit to another by fecal contamination of the feed, water and cage floors. Therefore, cage sanitation is a must. The greatest source of contamination is an infected doe who carries and sheds the disease but appears healthy. Putting sulfonamide drugs in the rabbits' water is reasonably effective against the spread of coccidiosis during outbreaks.

Rabbit syphilis (vent disease) The first signs of rabbit syphilis are usually small blisters, scabs or pustules around the external sex organs. As this bacterial infection progresses, similar sores may appear on the anus, eyelids, snout, lips and even the hocks.

This disease is transmitted by direct contact so it can be prevented by examining the genitals of both sexes before mating. Animals with infected genitals should be isolated and treated with penicillin. Use a propane torch to disinfect cages that have held infected stock.

Tyzzler's disease Tyzzler's disease is caused by a bacterium. It is rarely diagnosed, but appears to be on the increase. Recently weaned rabbits suffer profuse watery diarrhea, listlessness, lack of appetite and dehydration, followed by death in 12-48 hours. Tyzzler's disease can be confirmed only by postmortem examination. It causes pinpoint yellowish-gray spots on the liver.

It is transmitted by direct contact with fecal-contaminated feed and bedding. Stress, such as temperature extremes or overcrowding, may bring on the disease; thus good management and sanitation programs are emphasized once again.

Young doe syndrome (YDS) Young doe syndrome (the sudden death of young does after kindling) is a relatively new affliction that is spreading across North America. This syndrome occurs when first- or second-litter does die suddenly 2-4 weeks after kindling. The only symptom is reduced feed and water intake for 1-2 days prior to death. About half the does show excessive salivation around the mouth, while about 80% reveal intestinal impactions mostly in the cecum. The intestinal contents are non-toxic.⁹

There are several theories as to the cause of YDS. Though pregnant, the doe may not have reached full adult weight and size and may, therefore, be incapable of coping with the stress of producing a litter and reaching maximum lactation.

The cause of YDS could be a systemic infection that follows staphylococcal mastitis, in which case it can be treated with injections of potassium penicillin; or it may come from mismanagement, resulting in enterotoxemia.

High-energy (grain) diets may result in carbohydrate overload. This allows toxin-producing bacteria to proliferate rapidly. The liver cannot detoxify fast enough, and the rabbit dies. A suggested remedy is to increase the doe's feed very slowly following kindling, with larger additions of alfalfa. A preventative measure is reducing the feed of young does a couple of days before kindling so they cannot overeat.

Keeping the cage floor clean will help reduce bacteria, as will thorough ventilation.¹⁰

Other diseases and their treatments

Disease and symptoms	Cause	Treatment and control
<i>Ear mange or canker:</i> Shaking of head, scratching of ears. Brown scaly crusts at base of inner ear.	Ear mites — very contagious	Clean ear with an oil solution (e.g., mineral oil) twice weekly until all mites are eliminated. Isolate infected rabbits.
<i>Skin mange:</i> Reddened scaly skin, intense itching and scratching with some loss of fur.	Fur mites	A good mite powder used throughout the rabbitry might work, or treatment by veterinarian may be required. Best to destroy animals and blow-torch cages.
<i>Ringworm:</i> Circular denuded patches on face, feet and around anus	Fungus — generally from other rodents	Treat with suitable fungicide, and clean barn.
<i>Fungus infection:</i> Scaly skin over shoulders or along back. Hair thin, dandruff.	Fungus	Apply commercial fungicide or 2% solution of Lysol to affected areas every other day for 1 week.
<i>Tapeworm cysts:</i> Cannot usually be detected in live rabbits. Larval cysts in liver, intestines and stomach.	Larval stage of dog or cat tapeworm	No treatment — keep dogs and cats away from feed, feed, water and nest box material. Tapeworm eggs are found in dog and cat droppings.
<i>Nephritis (kidney disease):</i> Loss of condition. Severe hair loss. Kidney lesions.	Various causes. Nosema parasite passed through urine or to unborn in uterus.	No treatment available — destroy infected animals.
<i>Urine/hutch burn:</i> Inflammation of the external sex organs and anus. May bleed. Pus may be produced, if severe.	Bacterial infection of the membranes	Clean cages. Pay particular attention to areas where rabbits urinate. Local application of lanolin may be beneficial.
<i>Metritis:</i> White sticky discharge from female organs. Palpation indicates enlarged uterus.	Infection of uterus by variety of bacteria.	Destroy infected does and disinfect cages. Replace bucks, as they are carriers.
<i>Orchitis:</i> Infection or inflammation of the testicles	Pus-forming bacteria	Destroy afflicted bucks. Breeding bucks with orchitis may produce metritis in does and vice versa.
<i>Mastitis (blue breast):</i> Breasts feverish and pink, later turning black and purplish. Temperature elevated; appetite poor; won't nurse young.	Bacterial (usually staphylococcal) infection of the breasts	Intramuscular injections of penicillin. Do not transfer young to another doe. Destroy affected does as mastitis usually reoccurs.
<i>Caked breast:</i> Breasts become firm and congested with hard knots at sides of nipples.	Milk not drawn from glands as fast as formed.	Do not wean young abruptly.

Disease and symptoms	Cause	Treatment and control
<i>Conjunctivitis (weepy eyes):</i> Inflammation of eyelids with discharge causing fur around eye to become wet and matted.	Bacterial infection of eyelids. Also by airborne irritants.	Various eye ointments.
<i>Abscesses and boils:</i> Lumps occurring under skin over ribs and back, neck, dewlap, mammary glands.	Various bacteria.	May break and drain naturally. Ask vet for treatment.
<i>Pneumonia:</i> Dullness; quick labored breathing with nose held high. Bluish color to eyes and ears. Lungs congested.	Bacterial infection of the lungs.	Penicillin effective if administered early.
<i>Septicemia:</i> Often sudden death before any symptoms. Extreme weakness, greatly elevated temperature, heavy breathing.	Pasteurella bacteria infecting bloodstream.	Antibiotics. However, lack of clinical signs and short duration do not allow time for treatment.
<i>Peritonitis:</i> Elevated temperature; reluctance to move; tense, sore abdomen; fast, shallow breathing	Pasteurella bacteria infecting membrane lining abdomen	Antibiotics if diagnosed in time.

Abnormalities

There are a number of conditions which are not, strictly speaking, diseases, but which are not to be tolerated in a well-run rabbitry as they directly affect productivity and profitability.

Yellow fat The tendency to yellow fat is inherited. The market does not accept yellow fat in rabbits, not because yellow fat is harmful but because it is unsightly. Yellow fat is more easily seen in adult rabbits. Rabbits with yellow fat lack the enzyme that breaks down xanthophyll, a pigment found in green feeds. It is deposited in fatty tissues, turning them bright yellow.

Malocclusion (wolf teeth, buck teeth) Rabbit teeth never stop growing but at the same time they are constantly being worn down by chewing. When the teeth fail to meet at the proper angle, unusual growth will occur. Generally, the upper incisors turn inward and the lower ones turn outward preventing normal chewing action.

Signs of malocclusion are gradual loss of appetite and weight. Both sides of the mouth become stained with saliva. Because the rabbits are unable to chew properly, they become progressively listless, dehydrated and thin. Eventually they die from starvation.

The problem can be corrected temporarily by cutting back the teeth so the rabbits can eat and attain good condition prior to slaughter. Malocclusion can be the result of injury or an abscess, but it is more likely to be an inherited trait and can be eliminated through selective breeding.

Splay leg Splay leg is due to a recessive gene and is characterized by limbs that are twisted so that the animal seems double-jointed. The animals are neither paralyzed nor sick, but they should not be used for breeding.

Sore hocks Sore hocks are inflamed, infected, bruised, abscessed or raw bleeding spots found on the bottoms of the hind feet. The condition seems more likely to afflict the larger breeds. It results from inadequate foot fur and padding to enable the rabbit to withstand life on wire mesh floors. In all cases of sore hocks, the affected rabbit has thin fur padding on the hocks — an inherited tendency. It may appear in nervous bucks that engage in constant foot stamping. The rawness is further aggravated by water and urine, high humidity, increased or excess body weight or injury.

A rabbit with sore hocks will lie down a great deal or move about very gingerly, putting as much weight as possible on the front feet. This may make sores develop on the forefeet as well. Affected bucks and does will be reluctant to mate.

Severely affected animals should be culled. In milder cases, place rabbits in a well-drained pen with an earth floor. Clip any matted fur from the hocks. Every day wash the infected areas with warm, soapy water, dry thoroughly, then treat with a zinc or iodine ointment.

Clean and disinfect the cages of afflicted animals and inspect the wire floor for any rough spots.

Wry neck In young rabbits, wry neck can be caused by injury, but in adults it is usually the result of inflammation of the inner ear (often by canker). The rabbit loses its sense of balance and carries its head on one side with the eyes rolled up and backward. When it attempts to move, it rolls over. It cannot eat and eventually will starve to death unless culled. There is no treatment for wry neck.

Frightened rabbits sometimes race frantically around their cages. Wry neck may appear a day or two later — the result of injury sustained during the period of alarm.

Paralyzed hindquarters A broken back, displaced disc, or damage to the spinal cord and nerves will often result in paralysis. Pregnant does are often found dragging their hindquarters and unable to stand or to support pelvic weight. The bladder will fill but not empty. The only recourse is to kill the afflicted rabbit.

Glaucoma Glaucoma appears first as a light bluish cloudiness in the corner of one or both eyes. The eye becomes progressively opaque and the eyeball begins to protrude. Complications include reluctance to breed, poor appetite, loss of health and eventual blindness. Glaucoma is inherited and is transmitted as a recessive trait. Affected animals should be culled.

Fur chewing It is difficult to know why young rabbits start to chew each other's fur, eyelashes or whiskers. Overcrowding or boredom may be one reason; shortage of fiber, protein or iodine may be another. Fur chewing may also be just a bad habit.

When licking themselves clean, rabbits will swallow some fur which will not be digested. It may collect in the stomach and form a fur block that interferes with digestion. If you notice a rabbit is off its feed and that its droppings are linked together by fur fibers, it may have a fur block. An extra

ration of hay may move the blockage. In more severe cases, it is necessary to administer mineral oil by stomach tube to save the animal from dying of starvation. Some pineapple

and papaya enzyme preparations have been used successfully on Angora rabbits.

HERD MANAGEMENT

Success in raising rabbits depends upon efficient management. You must establish sound principles of breeding, handling, feeding, sanitation and disease control, culling and record keeping which together form the basis for a daily work routine. Establish a policy in which visitors are discouraged, bucks are not loaned and the routine of the rabbitry is upset as little as possible.

Handling rabbits

Becoming thoroughly acquainted with the characteristics, health and behavior of rabbits through daily inspection is essential. Because rabbits are excitable, you must learn to work quietly among them. They are often frightened by loud, strange or sudden noises, prompting them to stampepe around their cages and possibly injure themselves. They may also jump into the nest boxes and injure litters. A radio playing in the rabbitry can mask other noises and accustom the rabbits to a variety of sounds.

You need to lift and handle your stock to examine them for disease or injury or to move them. Never lift them by the ears or legs as that may injure them. Small rabbits may be lifted by grasping them around the loin. This method prevents bruising the carcass and damaging the pelt. A mature rabbit may be lifted by grasping the fold of skin over its shoulders with one hand and supporting its rump with the other hand. Tuck its head under your arm to calm it and keep it from struggling.

Rabbits can and will fight and scratch you. Clip their toenails if they become too long. Exceptionally mean-tempered rabbits should be culled from the herd. Everyone working with live rabbits should have tetanus shots, for a rabbit bite or scratch can cause this disease.

Rabbits that are used to being handled are easier to work with and are less subject to nervous stress than are those left untouched for long periods of time. Rabbits can be trained. Training does to submit to palpation and forced mating, for example, is particularly worthwhile.

Tattooing

Tattooing numbers in one ear of each rabbit kept for replacement stock is a good way to accurately identify all rabbits used in the breeding program. Proper identification is essential for record keeping.

To produce a tattoo, ink or dye must be inserted under the skin. The area to be tattooed should be cleaned with rubbing alcohol. Then the tattoo clamp is applied firmly, followed by an application of ink which can be rubbed in with a soft toothbrush or cotton swab. A final glaze of petroleum jelly will protect the puncture marks from infection.

During tattooing the rabbit should be restrained so it cannot injure itself or you. Tattoo boxes are rectangular boxes that



Figure 24 How to carry rabbits

adjust exactly to fit the length, breadth and height of a rabbit, making it immobile. The ears protrude through the top. However, if rabbits of various sizes are to be tattooed, even adjustable boxes will not be safe for all of them, particularly if the boxes allow even the slightest head movements. A rabbit that has room to wiggle during the tattooing process can injure itself badly, even breaking its neck. Restraining the animals in a towel or a clean burlap bag is effective and safe.

Determining sex

You must be able to determine the sex of young rabbits, particularly if you are selling breeding stock or laboratory specimens or selecting replacement stock. You can sex a bunny as early as 3 days after birth, but you run the risk of injuring the delicate organs. A good time to determine sex is at the 56-day weighing. (See section on Breeding programs.)



Figure 25 Determining sex: doe



Figure 26 Determining sex: buck

One method is to hold the rabbit's head between your thighs while supporting the hindquarters. With the forefinger of your free hand push the tail back from the anus and genitals, while with your thumb depress the area in front of the sex organs to expose the reddish mucous membrane. In the buck, the penis will protrude as a rounded tip, while in the doe the membrane will form a slit with a depression at the end of the anus.

Castration

In producing domestic rabbit meat for market, there is no advantage to castrating bucks to improve the rate of growth. Some breeders castrate fryer bucks to keep them from fighting, but the animals should be marketed long before the age at which they begin to fight. In a busy rabbitry, castration is a waste of time.

Sanitation and disease control

Good management, stringent sanitation and ruthless culling are all important in controlling disease. Preventing stress and disease is far more profitable than curing it. Sanitation can be time-consuming and laborious if you do not have equipment like a manure removal belt and humidity control, but the effort is worth it because it leads to a trouble-free operation.

Clean feeding utensils regularly (at least with each new litter) with a germicidal soap and water, then rinse in clear water. Allow the utensils to dry in the sun if possible.

Never move a rabbit into a cage that has not been thoroughly disinfected. Doe cages and nest boxes should be disinfected after each litter is weaned. Use a propane torch to burn off accumulations of hair — especially in times of molt — from the wire cages. Then scrub them with a disinfectant.

Dispose of manure as often as is necessary to keep ammonia fumes down and to control flies. Remove contaminated feed and burn soiled bedding. Make sure the rabbitry is free from vermin, and stray animals can't get inside. Keep it well ventilated, and avoid drafts and dampness. Maintain an even temperature.

Avoid overcrowding, and keep down the numbers of new stock introduced. Provide separate isolation pens for new rabbits or those returning from shows. Isolation time should be a minimum of 2 weeks. If they show signs of disease, destroy them. Incinerate or deeply bury the carcasses of dead animals.

Similarly, isolate sick animals or those suspected of having disease until you know they will not endanger the health of the herd.

Always tend to the isolation pens last in the daily routine, or have someone else with separate tools look after the unit.

Remember, you are the greatest carrier of rabbit diseases so wash thoroughly after handling sick animals. Do not lend bucks to other breeders, and do not permit visitors — especially from other rabbitries.

Disinfection never stops for whenever large numbers of animals are housed in a confined space, germs will circulate. The degree of contamination in a rabbitry can be ascertained by laboratory analysis of dust samples. A disinfection program can then be designed.

Germicidal paint on the walls and ceilings of the barn helps control bacteria. Clean the walls and floor with a biocide (like those used in dairies) that will penetrate concrete and wood. Use an iodine detergent for equipment. If automatic waterers are used, the lines should be flushed regularly with chlorine bleach, then with clear water. For the areas above the cages, use aerosol disinfectants. Aerosols can also be used to control insects.

Consulting a veterinarian

Your decision to consult a veterinarian will probably be based on the extent of disease in the rabbitry and the costs involved. If only one or two rabbits are sick and the problem is unlikely to spread, you may decide against consultation, because it may cost more than replacing the diseased animals with new stock.

As you increase your knowledge and expertise, you should be able to treat your own livestock, even to the extent of administering intramuscular doses of medication prescribed by a veterinarian. Whether you treat disease yourself or hire someone to do it, it takes valuable time, labor and money. A commercial breeder cannot afford to fuss with treating disease in animals that should be culled from the herd.

The use of drugs

The indiscriminate use of drugs for treating entire herds is often simply a sign of poor management. Drugs and treatment are expensive. Furthermore, indiscriminate use of antibiotics can lead to the development of antibiotic-resistant strains of bacteria.

You must be aware of the correct dosage, the concentration, and the method of administration of a drug as well as the length of time it must be withheld prior to marketing rabbits for human consumption.

Laboratory diagnosis

The best way to obtain an accurate diagnosis of a disease is to take the dead rabbits or two or three sick animals showing typical symptoms to a laboratory. Check with your provincial veterinary branch to find out what laboratory services are available to you.

Dead animals must be kept cool (but not frozen) until they can be delivered. Particular care should be taken in the summertime because it is impossible to make a proper examination of putrid material. The carcass should be wrapped in newspaper, packed in ice if necessary and delivered promptly.

At the lab, the pathologist may want to know the size of your herd, the number of sick or dead animals, their age and sex and a description of their symptoms. You should also be prepared to give information on the dates of the first and subsequent losses, the incidence of infection (i.e., just one cage or throughout the entire rabbitry) and what treatment, if any, you've already given. The pathologist might also want to know what type and brand of feed you've used in the past 6 months and the type and condition of housing.

While awaiting diagnosis, you should practice good hygiene to prevent the infection spreading.

Daily management schedule

Breeding Breeding and successful kindling generate the actual profit in a rabbitry, so breeding chores should have top priority on the daily job list. It is uneconomical to allow the breeding program to fall even a single day behind schedule.

Palpation It is vital to know that bred does are indeed pregnant. Palpate them on schedule (at 10-14 days) and if they're not pregnant, rebreed them immediately.

Nest boxes Nest boxes must be given to the does on day 28 of their pregnancies. If the addition of a nest box to a cage is delayed and a doe forced to kindle on the wire floor, her young may be lost, and so will one full month of production by her.

Litter and nest box inspection New litters should be inspected and counted as soon as possible, and fostering carried out where necessary.

Weighing Litters must always be weighed on day 21 so you can maintain exact records of the does' milk production. Fryers should be weighed at 56 days to determine the ratio of feed given to the weight gained.

Selecting replacement stock After weighing the 8-week old young, you can decide which ones to save for breeding. This is also the time for sexing and tattooing young rabbits and separating replacement stock from those to be marketed.

Feeding Feeding can be done later in the day. This suits the rabbits for they are most active at night. Some breeders feed them hay first thing in the morning to keep them occupied. If you have a small rabbitry, feeding time can also be a good time to check for injuries, abnormalities and disease.

Treating illness Treat ailing, injured or diseased animals after feeding.

Cleaning and disinfecting After caring for the rabbits, you can clean the barn, cages and utensils.

Record keeping Update your records each work day after all the chores have been done. How and when you record data will depend upon the size of your rabbitry and the record-keeping system you use. Rather than trusting memory, make notes of the tasks you have done as the work day progresses. (See section on Record keeping.) Good management is reflected in accurate up-to-date records.

Breeding programs

Your goal as a commercial meat producer is to raise fryers for sale. You can raise more fryers by working the does to the full extent of their reproductive capacity. You should attempt to keep more than 75% of the does bred or with litter and the conception rate (see Glossary) over 80%. You should aim for an average of eight or more young per litter. Set out to achieve specific weights by specific ages.

Litters should be uniform, with individuals weighing 350 g or more at 21 days and 2.2 kg or more at 56 days. Fryers should be marketable by 8 weeks of age.

There are different breeding programs used to obtain the maximum numbers of fryers per doe. Obviously, what works for one raiser may not work for another. You should decide what best suits your operation.

Five litters per year (42-day breed-back)

	Doe	Young
	Kindle	Birth
42 days	Rebreed	
56 days	Wean	Wean to market
73 days	Kindle	

This system is for hobbyists, not those trying to run a profitable commercial operation. You need fewer bucks, and fewer cages. There is less stress on the doe and her litter because they are not separated until the young are weaned to market. The young have a lower feed conversion. The does seem more ready to accept service of the buck when they still have young with them. The schedule is easy to manage. It has a relaxed pace ideal for beginners and hobbyists.

The obvious disadvantage to the 42-day program is that fewer fryers are produced per doe per year, but you still have to pay the cost of feeding the does. They easily become fat and lazy if not managed properly.

A good idea is to start with the five-litter per year program and stay with it until you have developed a good replacement program. Then you can consider a stepped-up breeding program if you think it would be profitable.

Nine litters per year (7-day breed-back)

	Doe	Young
7 days	Rebreed	
28 days	Wean	Wean
38 days	Kindle	
56 days		Market

With this system, your stock is in almost constant production, providing you with lots of fryers. Good does seem to thrive on the increased demands of this program and it is easier to identify and cull inferior ones.

The 7-day system, however, involves a lot more work. You will need more bucks and replacement stock. Some does will not be able to meet the demands of constant production, and those that do will have a shortened production life. There is greater mortality among the young and they face the stress of early weaning. There is higher feed conversion and supplemental feeding may be required. You will need more cages, probably two per doe, unless you use split cages. Finally you will have more work breeding, palpating, weaning and keeping records.

Nevertheless, this program is gaining popularity. Weaning the young at 28 days is logical because the doe's milk production declines abruptly during the fourth week, and as the young are eating mostly solid food by this time, their requirements for milk are minimal.

SELECTING REPLACEMENT STOCK

No matter how good the initial stock you purchase is you must constantly strive to improve the herd through culling and selection. Perhaps only 25% of your animals will be good producers, despite their good records and ancestry. You face the continuous challenge of upgrading the herd.

Methods of improvement

There are two methods of herd improvement. You can buy superior new stock from other raisers, or you can selectively

Remating the doe at about 7 days (depending upon her physical condition), and weaning the young at 28 days permits the doe to have a week alone before kindling her next litter. Her diet should be restricted (because lactation is no longer a demand) and her body allowed to devote its energy to the developing litter.

Further considerations

In the past, weaners were moved into large holding pens to fatten for market. However, they ate more but gained weight slowly in holding pens. This could be because two or more litters together creates stress and increases the competition for food. Another reason may be the increased space allows more room for exercise, leading to an increase in food consumption but with greater wastage of feed energy.

Moving the doe, or the litter from the cage in which they were born, is also stressful. On a stepped-up breeding program, it is better to use split cages allowing the rebred doe to be separate, but still close to her weaned litter.

Some producers are experimenting with post-partum remating (i.e., 3 to 6-day breed-back). The doe is rebred almost immediately after she has kindled, making it theoretically possible for her to produce 10 litters per year. Depending upon the strain of rabbit, assorted problems (including high infant and doe mortality) have occurred. It is important to build up a herd slowly to a stepped-up breeding schedule.

Breeding programs are really determined by the individual does. If a particular litter is small or can be reduced by fostering, and if the doe is in good condition, she can be rebred earlier than the chosen program dictates. To be economical, a healthy doe should be kept in production.

Unfortunately, a doe can and will stop production of her own accord. The fall barren periods are a frustration to producers trying to maintain a particular program of breeding. Also, when the condition of a doe declines because of increased demands of pregnancy and lactation, she may cease production for as long as 2-3 months until she has rebuilt her body resources. The production capabilities of individual does can help in the selection of their progeny as replacement stock. It is possible to develop a strain of rabbits that can handle a stepped-up breeding program.

The type of feeding program and the type of breeding program should be based on the amount of time you have, as well as a realistic anticipation of a return on your investment and labor.

mate your own rabbits to produce better offspring. Usually, both methods are combined.

With a small herd there is limited scope (depending upon the number of strains initially purchased) for improvement through selection. The cost of running a selective breeding program should, therefore, be measured against the cost of buying fresh stock at regular intervals. With small numbers of animals in closed breeding units, you risk inbreeding depression (i.e., loss of vigor). Furthermore, you should not start a selection program too soon. First, monitor the characteristics of your existing stock in order to identify what needs to be improved.

Any new breeding stock you select should be superior to that you already own. Test new rabbits on a small scale before fully integrating them into a breeding program.

One hazard of buying rabbits from other raisers is they may carry diseases into the rabbitry. For safety's sake, all new stock should be isolated from the herd for a minimum of 2 weeks.

If you raise your own replacement stock you know their history and ancestry. Each rabbit can be observed from birth, and they inherit a certain amount of disease resistance to the conditions of the home rabbitry.

However, raising your own replacement stock requires more cages, time and knowledge.

Start off with realistic standards and select as replacement stock the animals that come closest to them. As the herd improves, standards can be tightened. Replacement animals should be chosen for their health and vitality. They must not be judged alone but in relation to the entire litter. All littermates should be above average before any one of them is singled out as a possible replacement animal.

Initially you can select young stock from those does and bucks that produce the most meat. As the herd improves and your knowledge increases, you can start using the more accurate method of herd improvement known as progeny selection.

Progeny testing

With progeny testing, you grade rabbits not only on their own merits, but also on the records of their young. The characteristics of a high-production doe may not be genetically transmitted to her offspring. The progeny (young) must be tested against their parents to determine which qualities have been passed from one generation to the next. This means accurate herd records must be maintained.

Replacement numbers

In a large commercial venture, 35-40 replacement does are required each year for every 100 producing does. A new operation may replace up to 50% of its does each year. The numbers depend a great deal upon the quality of the breeding stock used as well as on the breeding program followed. The stringency of the culling policy will also influence the demand. You must keep more replacement animals than will actually be needed, because replacements may prove inadequate or contract disease and die. Furthermore, you have no dependable way of knowing how many replacements will be required at any one time in the future. You cannot wait until replacements are needed before producing them, because it takes cages out of production for several months.

The number of replacement bucks required depends, of course, on the size of the herd and the frequency with which they are used. Initially, services with a young buck should be restricted, gradually increasing until, on the average, he is mating seven does per week.

Both bucks and does should be replaced as soon your records show their productivity decreasing.

Selecting does

Don't save young from a doe's first litter. Wait until she has been in production for a while so you can choose young from a mother who is a proven producer.

The mother must be easy to breed. Receptivity to mating is a characteristic that can be inherited. The doe must also conceive readily. One that misses is uneconomical. She must kindle from 8-12 young per litter. Youngsters born in too-large litters are often smaller at birth and weaning age and have a higher mortality rate. Litters must be uniform at birth, or it may mean both doe and litter are not healthy.

The doe must be a good nurser; weighing her young at 3 weeks will give an indication of milk productivity. She must wean at least seven young weighing 2.2 kg each at 8 weeks of age.

She must be healthy and be able to stay in top physical condition.

The average productive life of a doe is 12-15 litters. The number of years that she is used depends upon the breeding program followed. Large does do not always produce the best stock. Generally, the doe should have good body length, well-defined hindquarters, and considerable depth to her loin. A longer doe mated with a short blocky buck (which most producers seem to prefer) produces a meatier fryer. The treasured does are the ones which regularly produce large healthy fryers with meaty carcasses. The performance record is often more important than the doe's appearance.

Selecting herd bucks

The characteristics of young rabbits depend 50% on their father. You can save does from the top 10% of the herd, but select bucks from only the top 2-3%, as they will father the offspring of all your does.

When selecting replacement bucks, choose those that are ready, consistent breeders with few misses. They should sire large youngsters in uniform litters.

The young should be free from defects and disease, fast-growing, and have meaty carcasses. The bucks should father litters that have a higher than herd average weight at 56 days.

The bucks themselves should convert their feed into muscle and energy so that they are active and virile year round. The final selection from several candidates may be based on feed efficiency. Keep a record of individual weight gains versus feed consumption for bucks from age 8-16 weeks. That enables you to select the buck with the very best feed conversion ratio.

While production performance is vital in selecting both does and bucks, the final criterion should be the production of young with solid meaty carcasses.

GENETICS AND BREEDING SYSTEMS

The goal of every commercial rabbit raiser is to produce litters of rabbits that are consistently profitable in terms of the amount of meat produced; that is, the cost of production should be less than the return from sales. Animals of poor quality or low productivity make rabbit raising unprofitable.

The first step toward herd improvement is to determine which characteristics need to be improved. A breeding program can then be planned. To breed with any degree of success, you must have some knowledge of genetics.

Genetics

Genes are the units of heredity. They are found in the chromosomes of every living cell. Rabbits have 22 pairs of chromosomes, or 44 chromosomes in total, in the nucleus of each cell. The sperm cells and egg cells contain one chromosome from each pair. In the process of fertilization, the 22 chromosomes from the buck are paired with the 22 chromosomes from the doe, resulting in a new combination of 44 paired chromosomes in embryonic cells.

Separation of the chromosomes (and the genes they contain) occurs during the formation of the sperm and egg cells. The recombination of cells containing the chromosomes at fertilization is random, hence the great variety among individuals. By selecting particular rabbits to be mated, you attempt to improve the population by increasing the incidence of desirable traits. The aim is to increase the odds that genes which will improve productivity and quality will be combined at fertilization.

Traits

A trait is a distinguishing feature or characteristic of an individual in character, habit or appearance. There are two groups to consider.

Qualitative traits Qualitative traits, often simply referred to as inherited, are controlled by one or only a few pairs of genes and are rarely affected by environment. These traits are described as being dominant or recessive. Those expressed by dominant genes will appear even though other genes are present. Traits expressed by recessive genes are masked by the dominant genes and may not appear for generations, or until they are matched with similar recessive genes.

Eye color, fur color and buck teeth are traits that are each determined by one pair of genes. The following table illustrates the pattern of occurrence for buck teeth.

		Doe	
		T	t
Buck	T	TT	Tt
	t	Tt	tt

Offspring

T = dominant trait; t = recessive trait

Both the buck and doe have normal teeth but carry the recessive gene (t) for buck teeth. Thus we see that 25% of the offspring will have buck teeth (tt) while 75% will have normal teeth. However, two out of every three of those with normal teeth still carry the gene for buck teeth which they will pass on to successive generations.

If one parent has no recessive gene for buck teeth but the other parent does, all of the offspring will appear normal, but half will still be carrying the recessive gene for buck teeth:

		Doe	
		T	t
Buck	T	TT	Tt
	T	TT	Tt

Offspring

T = dominant trait; t = recessive trait

Thus a pair of rabbits that complement each other can produce quality fryers but inferior breeding stock, because recessive traits may keep reappearing in succeeding generations.

Quantitative traits Quantitative traits are governed by many gene pairs, and their expression may be strongly influenced by environment. For instance, a rabbit's genetic potential for growth is determined at conception, but the conditions under which it is fed and managed determine whether or not it will meet that genetic potential. Heritability is a measure of the relative influence of heredity and environment on a trait. The following quantitative traits are listed in approximate order from most to least heritable. (Those traits with the highest heritability will be improved more rapidly.)

- Carcass dress-out weight
- Market weight
- Milking ability
- Feed efficiency
- Average daily weight gain
- Disease resistance
- Longevity
- Litter size

Rabbits chosen for breeding should be those exhibiting traits of high heritability and economic value.

Breeding systems

Once the individuals for breeding are chosen, a mating system must be established.

Random mating Random mating is the mating of randomly chosen individuals; that is, no consideration is given to the genetic relationship of the individuals being mated. Random mating neither improves nor decreases the performance of the offspring.

Inbreeding Inbreeding is the mating of closely related individuals; that is, brother and sister, father and offspring. Inbreeding can remove defects from the inbred line, and increase hybrid vigor when two inbred lines are crossed. Make sure there are no outstanding weaknesses in the participating family, because such close breeding intensifies every family characteristic. For example, if there is a tendency toward low milk production, this characteristic will be intensified in the offspring.

Inbreeding reduces the genetic variation in individuals. Both dominant and recessive genes become fixed, making inbreeding a most effective way to screen out carriers of detrimental recessive genes. With this system, very strict culling is necessary to eliminate undesirable traits. Also, if inbreeding is carried on for too many generations, the vigor

of the line will be diminished.

Linebreeding Linebreeding is the mating of less closely related individuals in an attempt to preserve or increase the genetic influence of a common ancestor. A buck may be bred to his half-sister or his grandmother. This intensifies the characteristics of a line with less chance of intensifying some obscure undesirable trait.

Linebreeding is most valuable when the common ancestor is deceased, for its genes can be concentrated through the matings of its relatives. It is imperative that the common ancestor be documented as a superior specimen. Most commercial breeders prefer linebreeding over inbreeding because there is less depression of vigor and reproductive performance.

Outcrossing Outcrossing is the mating of unrelated individuals within the same breed. Although these matings would normally be expected to result in improved performance, it is still necessary to select matings carefully to achieve maximum potential. For outcrossing you need to maintain two or more populations of animals. These popu-

lations could be maintained by random matings.

Crossbreeding Crossbreeding is the mating of individuals of different breeds. Such matings greatly increase the likelihood of hybrid vigor, especially for reproductive fitness traits, because the individuals being mated are more genetically diverse than with outcrossing. The first generation hybrids are very valuable because the young grow at a faster rate with better feed efficiency than if they were purebred.

To get the best economic results from hybrid superiority, the guiding rule is that the best purebreds will produce the best hybrids. Indiscriminate matings of unproven breed members can result in poor quality offspring.

It is possible through selective breeding, progeny testing and stringent culling to bring out the best in a herd. You may choose to keep several lines of unrelated animals within the herd so you can cross them for increased meat production. Whatever systems are used, the most important aspect to ensure success is a sound system of record keeping.

RECORD KEEPING

In any business, record keeping is important; in rabbit raising, it is absolutely essential. Because it takes time, only useful records should be kept. They should be simple but complete. The scale of the recording system adopted will depend in large part on your breeding program. The information obtained from the records will be used for breeding purposes and to judge the profitability of the rabbit-raising enterprise.

The important records will be those for pedigree of breeding stock, doe performance (milk production), buck performance, fryer production (including feed conversion ratios) and profit or loss. Keeping up-to-date records will also

enable you to plan your daily work schedule.

In setting up a records system, keep two things in mind: the entries should be made so that they can be easily summarized; and frequent transfer of data from one record form to another should be avoided to save time and decrease error.

The doe card

One of the most important records is the doe card. It should include the doe, sire and dam numbers (or names), dates of mating, 21-day litter weights, dates and numbers weaned and the weaned weights of the litters. Keep the card on the doe's cage, and if the doe is moved to a new cage, the card goes with her. It will indicate whether the doe conceives regularly throughout the year, how many young she raises

NAME OR EAR NO. _____ BORN _____ CAGE NO. _____

SIRE _____ DAM _____

SERVED BY	DATE	TESTED	KINDLED	NUMBER OF YOUNG					JRS. SAVED		21-DAY WEIGHT	REMARKS
				BORN	LEFT	ADDED	RAISED	DIED	BUCKS	DOES		

Figure 27 Sample doe card

Hutch No. Name or No.

Breed Sire

Date born Dam

Doe Serviced	Date Bred	RESULTS OF BREEDING			56 Days	
		Kindled		Date	Number	Weight
		Alive	Dead			

Figure 28 Sample buck card

and her milk production. The latter is determined by the 21-day weight of her litters.

The buck card

The buck card is a summary of his performance and is attached to his cage. As well as information regarding his identification, age and ancestry, details are recorded of each service he gives and the results of the service: the number born alive and dead, and the date, plus the 56-day weight of the litter and the number weaned.

The daily work card

Doe and buck cards are usually attached to the feeders of the cages for convenience. Although they carry essential information, you must still search through the entire rabbitry for

does to be bred, palpated or given nest boxes. In a large rabbitry, keeping all the duties sorted out and completed on time is a major concern. "The 31-day pocket file" is a system which lets you read at a glance the duties required on any given day in the rabbitry.

All does bred on one day are entered on a daily work card (like the one shown). If, for example, three does are bred on the first day of the cycle, the doe number, cage number and buck number are recorded on the card along with the date of breeding. The card is then placed in the eleventh pocket of a 31-day pocket file. The eleventh pocket corresponds with day 11 of the cycle.

On the eleventh day of the cycle, when the daily work card is read, the producer can see which three does are to be palpated. After palpation is completed, the date is written on

DAILY WORK CARD Date Bred Oct. 1 Date Palpate Oct. 11 -day Rebreed (NEW CARD)

Date Nest Box _____ Date Kindle _____ Date 5-day litter check _____ Date 21-day litter Wt _____

Date _____ -day Rebreed _____ (NEW CARD) Date 56-day Ltr. Wt. _____

(1) Doe No.	Cage No.	Buck No.	(2) Pregnant		(3) Nest Box	(4)-(5) Kindle		(6) Trans	(7) Dead 1-5 Days	(8) 21 Day Wt	(9) Day Re-breed	(10) 56 Day Wt.	Remarks
			Yes	No		(4) Live	(5) Dead						
25	8A	5											
22	8C	4											
27	10B	1											

Figure 29 Sample daily work card

the card and the card returned to the file under day 28, the day the does must be given nest boxes. (Any does found not to be pregnant are rebred and a new card written up for them and placed in the slot 11 days hence.) On day 28, the first card is removed from slot 28, and the producer puts nest boxes into the appropriate cages and moves the card up to slot 31. On day 31 the same card will indicate which does are due to kindle. When they do, the rebreeding date is written on the card and it is returned to the correct slot in the file. And so the process continues until the young are weaned.

The daily work card and a 31-day rotational filing system can be used in rabbitries of all sizes and can be adapted to any breeding program. The system is simple and foolproof, if the cards are kept up to date.

Feed conversion ratio

In determining the profitability of your rabbitry, you must keep a constant eye on the ratio between the amount of food the rabbits consume and the number of kilograms of meat they produce: the feed conversion ratio (FCR). One method of calculating the FCR is to record the amount of feed given daily to a doe from the day she is bred to the day the young from that breeding are weaned. The feed card remains with the young to record the amount of food they consume until they are slaughtered. To the figures on the card is added the appropriate fraction (obtained from the ratio of bucks to does in the rabbitry) of the buck's ration during the time for which the figures are being recorded. The total amount of feed consumed is then calculated and divided by the total weight of the litter at the time of slaughter. The resulting figure (for example 3.5) tells the producer that 3.5 kg of feed were required to produce 1 kg of rabbit. The FCR is 3.5:1. The aim is to keep the ratio as low as possible.

The FCR obtained in the above manner does not, however, give the FCR for the total rabbitry. The true ratio is obtained by dividing the total amount of feed consumed over a set period of time (e.g., 1 month) by the total weight of the rabbits marketed during that time. The resulting figure takes into account the feed consumed by replacement stock and animals that die or are culled, and the feed lost by spillage or poor management.

Herd production summaries

Some composite records must be kept to help you assess the performance of the entire herd as well as to evaluate the production of fryers. These are usually herd production summaries which describe the state of the herd on a regular basis (usually monthly), much the same way as a monthly balance sheet does in financial accounting. The following is a sample of a summary. A monthly feed conversion ratio or the number of kilograms marketed may also be added according to the requirements and interest of the producer.

Herd production summary

For the month of _____ 19____

A Summary of production

1. Number of breedings _____
2. Number of conceptions _____
3. Number of misses (subtract #2 from #1) _____
4. Percentage of conceptions
(divide #2 by #1 × 100) _____

B Summary of gestation and kindling

5. Number of does kindling _____
6. Number of does dying prior to kindling _____
7. Number of does sold prior to kindling _____
8. Number of litters dead within first 3 days _____
9. Number of litters transferred in
first 3 days _____
10. Number of does left with a litter
(subtract sum of #7 and #8 from #4) _____

C Summary of growing period

11. Number of litters destroyed _____
12. Number of litters transferred during
growing period _____
13. Number of does that raised a litter
(subtract sum of #10 and #11 from #9) _____

D Summary of young produced

14. Total young kindled and left with doe
to raise _____
15. Total young weaned _____
16. Percent weaned (divide #14 by #13 × 100) _____
17. Average number in litter raised per doe _____
18. Total weight weaned _____
19. Average weaned weight of the young
(divide #17 by #16) _____

E Summary of mortality

20. Number of young that died in:
24 hr _____ 48 hr _____ 1 wk _____ 1 mo _____
 21. Deaths: Does _____ Bucks _____
 22. Number of grower and replacement stock deaths: _____
Total number of deaths _____
-

Financial records

As in all businesses, financial records must be kept. The final judgment of the success of the rabbitry is whether or not it is profitable.

Pedigree book

If you decide to raise rabbits for sale as breeding stock or develop a program for producing replacement stock, some records of ancestry must be kept on the identities of sires, dams and grandparents. Some description of the characteristics and production records of each animal in the breeding program is a worthwhile addition. Though simple pedigree cards such as the one shown are available from feed companies, notebooks with simple comments regarding litter size, mothering ability, etc., are valuable.

Using home computers

Running a rabbitry is a labor-intensive enterprise and computers are ideally suited to keeping all the records you may require. A computer program can be designed to store all herd information, provide a daily work sheet, record breeder and litter performance, run a genetic program for selecting or culling stock, provide monthly summary sheets, calculate feed conversion ratios, keep track of the monetary transactions and even evaluate the maternal ability of the does. Personal computers are no longer expensive and the larger the rabbitry, the more beneficial one would be to reduce the costs of labor.

BREED _____	SEX _____												
<p>SIRE</p> <p>REG. NO. _____ WT. _____</p> <p>NAME _____</p> <p>REG. NO. _____ WT. _____</p> <p>DAM</p> <p>REG. NO. _____ WT. _____</p> <p>BORN _____</p> <p>WEANED _____</p>	<table border="0" style="width: 100%; border-collapse: collapse;"> <tr> <td style="font-size: 3em; vertical-align: middle;">}</td> <td style="border-bottom: 1px solid black; padding: 2px 10px;">REG. NO. _____ WT. _____</td> </tr> <tr> <td style="font-size: 3em; vertical-align: middle;">}</td> <td style="border-bottom: 1px solid black; padding: 2px 10px;">REG. NO. _____ WT. _____</td> </tr> <tr> <td style="font-size: 3em; vertical-align: middle;">}</td> <td style="border-bottom: 1px solid black; padding: 2px 10px;">REG. NO. _____ WT. _____</td> </tr> <tr> <td style="font-size: 3em; vertical-align: middle;">}</td> <td style="border-bottom: 1px solid black; padding: 2px 10px;">REG. NO. _____ WT. _____</td> </tr> <tr> <td style="font-size: 3em; vertical-align: middle;">}</td> <td style="border-bottom: 1px solid black; padding: 2px 10px;">REG. NO. _____ WT. _____</td> </tr> <tr> <td style="font-size: 3em; vertical-align: middle;">}</td> <td style="border-bottom: 1px solid black; padding: 2px 10px;">REG. NO. _____ WT. _____</td> </tr> </table>	}	REG. NO. _____ WT. _____	}	REG. NO. _____ WT. _____	}	REG. NO. _____ WT. _____	}	REG. NO. _____ WT. _____	}	REG. NO. _____ WT. _____	}	REG. NO. _____ WT. _____
}	REG. NO. _____ WT. _____												
}	REG. NO. _____ WT. _____												
}	REG. NO. _____ WT. _____												
}	REG. NO. _____ WT. _____												
}	REG. NO. _____ WT. _____												
}	REG. NO. _____ WT. _____												

Figure 30 Sample pedigree card

PROBLEMS OF EXPANSION

Although the market for rabbit meat is increasing steadily, it is still best to start small. The meat rabbit industry is still in its early stages, and eager would-be rabbit raisers are advised to practise raising rabbits for a year or two before venturing into larger operations. Anyone who cannot raise rabbits successfully on a small scale will surely be unsuccessful on a large scale.

If you have been successful managing a small herd and wish to expand, you should first consider if a larger herd would be viable.

The market must be able to support an increase in the supply of rabbits. You can increase market capacity by promoting rabbits as a meat source and working with processors and with other commercial rabbit producers. Make sure your processor can handle the increased supply.

If you expand, you increase the demands on all aspects of management, from labor to record keeping. The chores of cleaning, disinfecting and sanitizing the rabbitry will increase dramatically to the point where you will have to invest in mechanical aids (such as a manure removal system). Automated watering and feeding must be installed, otherwise you would spend all your time seeing to these tasks.

Expanding the herd means expanding the housing. The larger the herd, the better the building should be in both design and construction. Your financial investment will increase accordingly. To raise several hundred breeding does, multi-tiered cages might be needed to reduce the housing costs per doe. This cage layout makes a greater demand on management.

As costs rise, you must market more fryers in order to maintain a cash flow to balance fixed costs. A faster breed-back system must be used; this increases stress in the herd and makes more demands on management. The stepped-up breeding program will require more cages for production and for replacement stock. The extra replacement stock increases the feed conversion ratio for the entire rabbitry.

Isolation wards must also be expanded. In most commercial rabbitries, isolation wards are in buildings separate from the main rabbitry.

As the operation increases in size, replacement stock must be constantly upgraded. Mediocre animals will not support the business; only exceptional breeding stock should be used. Most producers, in an effort to expand their rabbitries quickly, save too many inferior does. Only half the average litter are does, and of these, only one or two may be exceptional enough to save. These juniors must be kept for 6 months before their performance can be rated.

A negative cash flow is generally experienced during times of herd expansion and may last for 2 or 3 years. One of the reasons is that rabbits are being saved, not sold. Expansion must be carefully planned in order to balance increased expenses such as building costs with regular bills and temporarily reduced income.

Disease control becomes more difficult when rabbits by the hundreds are housed in one facility, but a well-designed barn and good management can offset this.

Record keeping in a large rabbitry can become a full-time job. A large commercial operation (e.g., 500 does or more) would probably require a personal computer.

The rabbit industry today consists of many small herds rather than large commercial operations. The current production methods are for the most part uneconomic and too labor-intensive to suit the time and interest of the average raiser. Equipment, facilities and management practices are not suited to intensive production and they yield a product of uneven quality and unreliable delivery. The rabbit industry will not become competitive with other livestock industries until these methods are improved.

According to a recent study undertaken at Colorado State University,¹¹ the primary factors contributing to the low profit margins are: seasonal breeding behavior, respiratory diseases, inadequate sanitation and mortality prevention, high nestbox mortality, unsound economic practices and inadequate investment in the rabbitry.

Still there are those who firmly believe in the future of the domestic rabbit and who are striving to make improvements in all aspects of the commercial rabbit industry. They are also willing to help the novice develop a financially viable operation.

There are many who raise rabbits for the joy of it; there are others who raise rabbits because of the challenge they present to management. Whatever the reasons, rabbit raising can be rewarding.

GLOSSARY

Abscess — a localized collection of pus in the body; a boil

Adult — a rabbit over 6 months of age

Anorexia — the absence of appetite

Back — the entire top portion of the rabbit extending from the neck to tail; the area covered by the backbone

Breed — a group or class of animals sharing distinctive characteristics such as fur markings, size, etc.

Buck — a male rabbit

Caked udder — inflamed and feverish teats in a doe arising from a superabundance of milk

Cannibalism — a doe eating her own young

Carcass yield — the dressing percentage obtained by dividing the weight of the dressed carcass by the weight of the live rabbit $\times 100$

Chest — the front portion of the body between the forelegs and neck

Chromosomes — rod-like structures containing the genes and occurring in pairs in the nucleus of a cell

Colostrum — the first milk produced by a doe after she gives birth

Conception rate — a percentage obtained by dividing the number of litters born by the number of matings $\times 100$

Condition — a rabbit's physical state; revealed by health, firmness of flesh, brightness of eye, etc.

Confined mating — putting a doe in with a buck for several hours

Coprophagy — consuming soft night feces directly from the anus; pseudorumination

Crossbreeding — mating rabbits of two entirely different breeds or varieties

Cull — selecting and disposing of undesirable or diseased animals

Dam — the female parent

Dewlap — a pendulous fold of loose skin hanging from the throat

Doe — a female rabbit

Dominant — the genes or characteristics which suppress the expression of subordinate or recessive characteristics

Dress-out — see carcass yield

Estrus — a recurring period in a female when she is more apt to conceive; a period of sexual heat

Fines — dust from pelletized food

Feed efficiency — the amount of feed required for a rabbit to gain one kilogram of weight (feed conversion ratio)

Flank — the sides of the rabbit between the ribs and the hips, above the belly

Follicles — the sacs in which the egg cells are produced

Forced mating — restraining the doe so that she may be mounted for mating by the buck

Fostering — giving the young of one doe to another to be raised

Full-feeding — making feed available to rabbits at all times so that they may feed at will

Fryers — tender young rabbits under 12 weeks of age and weighing between 1.8 kg and 2.75 kg

Genes — the units of heredity in a chromosome, controlling the particular inherited characteristics of an individual

Gene pool — the number and variety of genes within a breeding herd

Genetic relationship — the number or percentage of genes that an individual has in common with its relative(s)

Gestation — the period of time from mating of the doe to kindling

Heredity — the property by which the offspring have the nature and characteristics of parents and ancestors; the genetic constitution of an individual

Heritability — that which may be inherited

Hock — the middle joint or section of the hind leg between the foot and hip

Hybrid — the offspring of two rabbits of different breeds or varieties

Hybrid vigor (heterosis) — the tendency of crossbred rabbits to show qualities superior to those of both parents

Inbreeding — the mating of closely related animals

Inbreeding depression — diminished vigor

Induced ovulation — the releasing of egg cells in the doe triggered by sexual stimulation

Junior — a rabbit less than 6 months of age

Kindle — to give birth (used specifically for rabbits)

Lactation — the secretion of milk by the doe

Litter — a number of young being raised by one doe

Linebreeding — the breeding of distantly related individuals within the same strain

Loin — the portion of the back on either side of the spine, between the hips and the ribs

Malocclusion (buck teeth or wolf teeth) — teeth that do not meet or close properly.

Meaty — having good proportion of meat in relation to body size and type of, especially in the forequarters, back, saddle, loins and haunches

Mortality — loss of life; the number of deaths in a given period; death rate

Neonatal — newly born

Nutrient — any chemical compound or group of compounds of the same chemical composition that aids in supporting life

Outbreeding (outcrossing) — the mating of two rabbits of the same breed but of different bloodlines or strains

Ovulation — the releasing of eggs for fertilization

Pair — a male and a female rabbit of one variety

Palpate — to feel for developing young in the uterus through the abdominal wall of the doe

Parasites — internal or external organisms that live in or on a host and obtain food, shelter, etc. from it

Pedigree — a written chart showing the ancestors of the rabbit, date of birth, sex breed, etc.

Postpartum — following birth

Pot belly — distended stomach and intestines caused by improper food, usually found in young rabbits

Progeny testing — judging the worth of the parents by the performance of their offspring

Purebred — an animal that possesses the characteristics specified in a breed standard set by a breed association

Random mating — mating within a selected group with no attention to a definite mating system or herd improvement

Recessive — the characteristic of one parent which, when transmitted to offspring, is concealed by the dominant characteristic of the other parent

Registration — the official recording of a rabbit that has been approved by a licensed registrar

Roaster — a marketed rabbit larger and older than a fryer — usually 2.75 kg or more live weight

Roughage — course fiber such as hay, grass, etc.

Rump — the hind portion of the back and backbone

Saddle — the rounded intermediate portion of the back between the shoulder and loin

Selection — choosing animals best fitted for production, etc.

Senior — a rabbit 6 months of age or older

Sexing — determining the sex of a rabbit

Sire — the male parent

Slobbers — excessive salivation around the mouth and lower jaw

Snuffles — a contagious infection of the nasal passage and respiratory organs, also called Pasteurellosis

Sore hocks — ulcerated footpads or soles of the feet

Standard — the characteristics for a breed of rabbits as written up and approved by a registering organization

Strain — rabbits in any standard breed with the same family blood having the quality of reproducing marked characteristics

Stress — pressure or strain on an animal caused by an adverse force or influence, often resulting in changes in health and condition

Stringy — the quality of having ropy or sinewy flesh — noticeable in the larger breeds of rabbits not properly fattened for market

Swayback — having a distinct fall or scoop in that portion of the back between the shoulders and the hindquarters

Tattoo — to make a permanent identification mark in the ear of a rabbit through use of a perforating instrument and the application of ink

Trait — distinguishing feature in character, appearance, habit or portrayal

Typical — serving as an ideal representation of any given breed or variety as applied to type, color or fur quality

Variety — a group within a breed identified by color Wall eyes (moon eyes) — having a milky film over the cornea

Weaning — separating the young from the doe

Wry tail — tail abnormally bent, curled or twisted permanently to one side

Wry neck — head twisted to one side due to loss of equilibrium caused by inflammation of the inner ear or injury

ENDNOTES

¹ Lukefahr, S.D. et al, "Evaluation of the Flemish Giant as a Purebred and a Terminal-sire Commercial Rabbit Breed", *Journal of Applied Rabbit Research* (OSU 1980), Vol. 3, No. 3, p. 14.

² Pote, L.M., P.R. Cheeke, N.M. Patton, "Uses of Greens as a Supplement to a Pelleted Diet for Growing Rabbits", *Journal of Applied Rabbit Research* (OSU 1980), Vol. 3, No. 4, p. 15.

³ Cheeke, P.R., and N.M. Patton, "Carbohydrate Overload of the Hindgut — A Probable Cause of Enteritis", *Journal of Applied Rabbit Research* (OSU 1980), Vol. 3, No. 3, p. 20.

⁴ Enos, H.L., D.D. Caveny, B.L. West, G. Heidbrink, "Equipment and Management Options to Facilitate Year-round Rabbit Production", *The Domestic Rabbit: Potentials, Problems, and Current Research*, (OSU 1979), p. 38.

⁵ Netherway, Marjorie E.P., *A Manual of Rabbit Farming*, (London 1977), p. 39.

⁶ Gouvernement du Québec, *Lapin de chair* (1980), p. 14.

⁷ *Agriculture Handbook No. 490*, U.S. Department of Agriculture (1976), p. 30.

⁸ Ibid.

⁹ Patton, N.M., "Young Doe Syndrome", *Rabbit Research Center Newsletter*, Oregon State University, July 1979, Vol. 12, No. 3, p. 11.

¹⁰ Patton, N.M., and P.R. Cheeke, "Etiology and Treatment of Young Doe Syndrome", *Journal of Applied Rabbit Research* (OSU 1980), Vol. 3, No. 3, p. 23.

¹¹ Enos, H.L., D.D. Caveny, et al, "Equipment Management Options to Facilitate Year-round Rabbit Production", *OSU Rabbit Research Center Newsletter*, Vol. 2, No. 4, p. 10.

REFERENCES

Material for this publication, originally prepared for Alberta Agriculture by Briarpatch Farm Ltd., came from many sources, including:

Commercial Rabbit Raising, Agriculture Handbook No. 308, U.S. Department of Agriculture, 1971.

Domestic Rabbits: Diseases and Parasites, Agriculture Handbook No. 490, U.S. Department of Agriculture, 1976.

Journal of Applied Rabbit Research, Oregon State University, Corvallis, Oregon.

Manual of Rabbit Farming, by Marjorie E.P. Netherway, 1977.

Official Guidebook of the American Rabbit Breeders Association Inc., Bloomington, Ill., 1973.

Rabbits, a magazine published by Countryside Publications, Waterloo, Wisconsin.

Raising Rabbits the Modern Way, by Robert Bennet, 1975.

Oregon State University Rabbit Research Center, Corvallis, Oregon.

Equipment Management Options to Facilitate Year-Round Rabbit Production, by H.L. Enos and D.D. Caveny et al, Colorado State University, Fort Collins, Colorado.

CAL/BCA OTTAWA K1A 0C5



3 9073 00187684 8

