



Food  
and  
Agriculture  
Organization  
of  
the  
United  
Nations

ISSN 1010-9021



# THE RABBIT

Husbandry, health  
and production

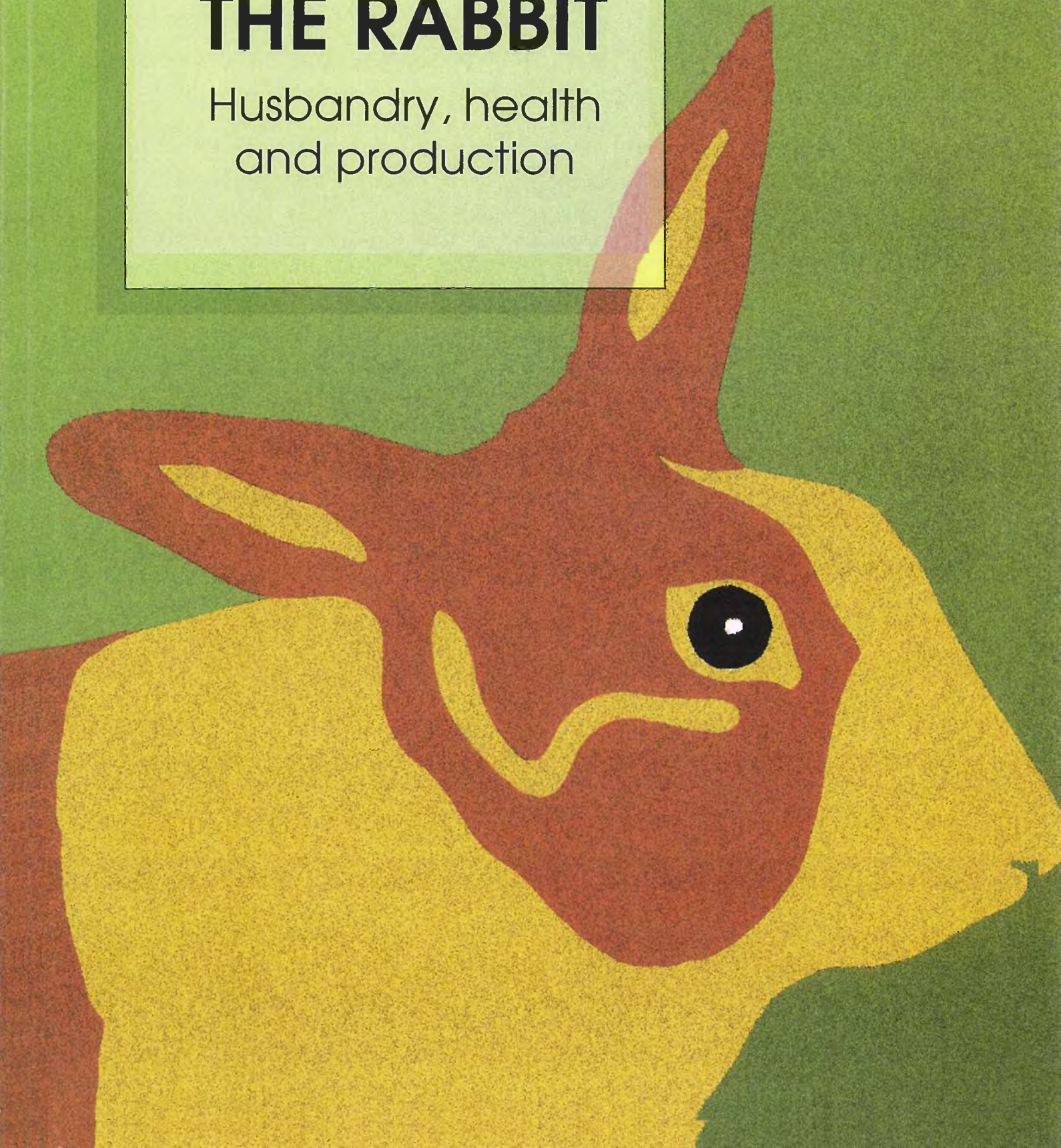

Rabbits reared with techniques adapted to specific environments can do much to improve the family diet of many of the neediest rural families, at the same time supplying a regular source of income.

The purpose of this work is to bring together as fully and objectively as possible all the available data on rabbit husbandry, health and production. It is also intended as a contribution to the preparation and execution of rabbit development programmes, particularly in developing countries.

A team of scientists from the French National Institute for Agricultural Research (INRA), a world-renowned rabbit authority, was marshalled to cover the many and varied aspects of rabbit production.

# THE RABBIT

## Husbandry, health and production

(new revised version)

by

**F. Lebas**

Agricultural Engineer

**P. Coudert**

Veterinary Surgeon

**H. de Rochambeau**

Agricultural Engineer

**R.G. Thébault**

Engineer (INRA)

The designations employed and the presentation of material in this publication do not imply the expression of any opinion whatsoever on the part of the Food and Agriculture Organization of the United Nations concerning the legal status of any country, territory, city or area or of its authorities, or concerning the delimitation of its frontiers or boundaries.

David Lubin Memorial Library Cataloguing in Publication Data

Lebas, F.

The rabbit: husbandry, health and production  
(new revised version)  
ISBN 92-5-103441-9

(FAO Animal Production and Health Series, no. 21)  
ISSN 1010-9021

1. Rabbits 2. Animal husbandry  
3. Pathology

I. Title II. Series III. FAO, Rome (Italy)  
IV. Coudert, P. V. de Rochambeau, H.  
VI. Thébault, R.G.

FAO code: 21 AGRIS: L01

All rights reserved. No part of this publication may be reproduced, stored in a retrieval system, or transmitted in any form or by any means, electronic, mechanical, photocopying or otherwise, without the prior permission of the copyright owner. Applications for such permission, with a statement of the purpose and extent of the reproduction, should be addressed to the Director, Information Division, Food and Agriculture Organization of the United Nations, Viale delle Terme di Caracalla, 00100 Rome, Italy.

© FAO 1997

---

## Foreword

Despite considerable progress in food production in the last 30 years, 800 million people in the world are still undernourished. This is not only because of food deficits and inadequate distribution: the incomes of the poorest are too small to allow them to procure wholesome food in sufficient quantities.

Livestock production is a major component of farm economies in developing countries, contributing not only food but also hides, fibres, fertilizer and fuel, as well as a modest, interest-producing capital which can easily be mobilized when unforeseen needs arise. In addition, livestock, whether large or small, are part of the social and cultural reality of several million small farmers, for whom husbandry represents an element of economic stability and sustainability. Both human and livestock populations have grown considerably in the last 30 years, but the rates in developed and developing countries are not comparable. Whereas the global human population has risen by 75 percent since 1960, in the developing countries the rate of increase was 97 percent and in the industrialized countries 28 percent. All species of livestock populations increased, but monogastrics (pigs and poultry) much more than ruminants.

Small-animal husbandry can be a very lucrative operation for both landed and landless small farmers; providing work for women, children and the handicapped (the least privileged social strata), producing substantial income and helping to upgrade the family diet. Many small domesticated species (guinea-pigs, capybara, cane rats, etc.) meet these objectives, but rabbit husbandry is far more prevalent, particularly in the Mediterranean area. Certain traditional rabbit production systems particularly adapted to hot, dry, semi-arid countries have been successfully developed.

Backyard rabbitries are particularly well suited to small farmers, whether they own land or not. The advantages are closely related to the reproductive and feeding behaviour of rabbits and the fact that the species is both profitable and easy to integrate:

- as a small monogastric herbivore, the rabbit easily accommodates a fairly wide range of cellulose-rich foods;
- it is adaptable to the family diet and food preservation techniques available on small rural and peri-urban farms;
- it is highly productive in terms of offspring (kg/year/dam) thanks to mating-induced ovulation, short gestation and lactation periods and great prolificacy;
- it produces highly nutritious, low-fat, low-cholesterol meat;
- it is easy to transport and market and the recurrent costs for maintaining animals beyond the optimum marketing age are low;
- labour costs are low and the work can be done by family members: women and children, or perhaps aged or handicapped people, usually the most vulnerable and least privileged social strata, for whom rabbit husbandry,

like that of other small animals, represents an attractive and remunerative occupation;

- it represents a contribution to the family income;
- investment is low: infrastructure and equipment can easily be put together by the breeder and not much space is needed.

Backyard rabbitries are the perfect answer to today's demand for sustainable development projects. For this reason, the Food and Agriculture Organization of the United Nations (FAO) and governmental and non-governmental development organizations have given firm and virtually universal support to rabbit projects in the developing countries. In the last ten years, FAO's Animal Production and Health Division (AGA) has supported and developed rabbit projects in Egypt, Ghana, Guinea-Bissau, Equatorial Guinea, Haiti, Mexico, Rwanda, Sao Tome and Principe and the Democratic Republic of the Congo (former Zaire).

However, projects which have been successful have not had the expected catalytic effect and others have heavily regressed or completely disappeared. It would be a good idea to pinpoint the reasons for these failures and seek the most appropriate solutions before attempting to relaunch such activities.

Constraints may concern:

- social, cultural and economic factors: customer acceptance of rabbit meat and ease of marketing;
- a lack of local resources available for balanced, low-cost, locally adapted rations;
- the existence of rabbit housing and management styles that inhibit the range of rabbit territorial, social, sexual, material and feeding behaviours;
- the presence of diseases representing a set of syndromes, rather than specific pathologies: if so, the appropriate approach would be an ecopathological one;
- breeder training: breeders may be unfamiliar with this species, which has very different behavioural characteristics from other domesticated species.

Training should include useful theory and solid practical apprenticeship.

By the year 2010, the world population will have risen from the present 5.4 billion to 7.2 billion, moving past nine billion by 2025. This increase will be felt mainly in the developing countries, where the corollary will be sizeable growth of the peripheries of urban conurbations, increased pressure on available land and major changes in the composition of animal populations. There will also be substantial impact on available natural resources and on the future demand for livestock products. This will have a profound effect on the choice of feed resources and livestock systems.

More land will have to be allocated for food production, reducing the feed resources (natural rangeland, pastures, forage) available to feed this growing population, as can already be seen in Asia. Even so, appropriate technology can release additional harvest residues and agro-industrial by-products which can be used for livestock feed. Clearly, enhanced food production requires more efficient utilization of natural resources and the development of alternatives such as rabbit husbandry.

This is why this manual, first published in 1984, is now being reissued. This very successful publication, translated into English and Spanish and reissued in 1990, has

long been out of print. An update thus became imperative in light of the major new developments and progress in rabbit husbandry in the last ten years. Publication of the handbook, delayed for many months, coincided with the Sixth World Rabbit Congress held in Toulouse from 8 to 12 July 1996. This meeting reported on the latest and best rabbit technologies, as well as those which can contribute effectively to food self-sufficiency in low-income food-deficit countries through sustainable production models.

FAO is indebted to the National Institute for Agricultural Research (INRA) team under the leadership of François Lebas for their contribution to this edition, their fine work and the many concrete instances of fruitful, joint collaboration over the last few years.

**R.D. Branckaert**

Livestock Production Specialist

Animal Production Service

Animal Production and Health Division





---

# Contents

Foreword	iii
<hr/>	
Chapter 1	
<b>INTRODUCTION AND BACKGROUND</b>	<b>1</b>
World production and trade	1
Historical background	1
World production	5
International trade	10
Rabbit meat quality	13
<hr/>	
Chapter 2	
<b>NUTRITION AND FEEDING</b>	<b>19</b>
Anatomy and physiology	19
Feeding behaviour	22
Nutritional needs	28
Feeding systems	36
<hr/>	
Chapter 3	
<b>REPRODUCTION</b>	<b>45</b>
Anatomy of the genitals	45
Reproduction physiology	45
Reproduction and environment	54
Rates of reproduction	55
<hr/>	
Chapter 4	
<b>GENETICS AND SELECTION</b>	<b>61</b>
Introduction	61
Genetics of rabbit breeds and populations	61
Genetics of breeding characters	71
Genetic improvement: selection and crossing	81
Conclusions	92
<hr/>	
Chapter 5	
<b>PATHOLOGY</b>	<b>95</b>
Introduction	95
Appearance and development of diseases	95
Intestinal diseases	97
Respiratory diseases	111
Other disorders of the rabbit	114
Zoonoses	118
Trypanosomiasis	119

---

<b>Reproductive diseases and disorders</b>	<b>120</b>
<b>Preventive hygiene</b>	<b>122</b>
<hr/>	
Chapter 6	
<b>HOUSING AND EQUIPMENT</b>	<b>125</b>
<b>Biological considerations</b>	<b>125</b>
<b>Rabbitry equipment</b>	<b>130</b>
<b>Buildings</b>	<b>141</b>
<b>Unconventional housing</b>	<b>144</b>
<b>Uses for waste</b>	<b>146</b>
<hr/>	
Chapter 7	
<b>RABBITRY MANAGEMENT</b>	<b>149</b>
<b>The production cycle</b>	<b>149</b>
<b>Handling rabbits</b>	<b>153</b>
<b>Organizing and managing a rabbitry</b>	<b>154</b>
<b>Some production targets</b>	<b>161</b>
<hr/>	
Chapter 8	
<b>PRODUCTION OF RABBIT SKINS AND HAIR FOR TEXTILES</b>	<b>165</b>
<b>Rabbit skins: a by-product of meat</b>	<b>165</b>
<b>Production of quality furs</b>	<b>167</b>
<b>Collection, preservation and storage of pelts</b>	<b>169</b>
<b>Curing and glossing</b>	<b>170</b>
<b>Conclusions on fur production</b>	<b>171</b>
<b>Angora</b>	<b>172</b>
<b>Angora: characteristics</b>	<b>172</b>
<b>Raising Angora rabbits</b>	<b>174</b>
<b>Sources of variation in angora hair production</b>	<b>177</b>
<b>Prospects for angora wool production</b>	<b>178</b>
<hr/>	
Chapter 9	
<b>RABBIT BREEDING AND RURAL DEVELOPMENT</b>	<b>181</b>
<b>The Mexican "family packages" programme</b>	<b>181</b>
<b>The situation in 1993</b>	<b>194</b>
<b>A development programme using rabbits</b>	<b>195</b>
<hr/>	
<b>BIBLIOGRAPHY</b>	<b>199</b>
<hr/>	
<b>FURTHER READING</b>	<b>204</b>
<hr/>	
<b>SPECIALIZED REVIEWS AND PERIODICALS</b>	<b>205</b>
<hr/>	

---

# Tables

---

<b>Table 1</b> Average performance of different animal species and energy cost of proteins they produce	2
<b>Table 2</b> Production trends in France from 1950 to 1990 in the most productive rabbitries	4
<b>Table 3</b> Major rabbit-producing countries in 1990	5
<b>Table 4</b> Estimated annual consumption of rabbit meat by country	8
<b>Table 5</b> Major rabbit meat importing and exporting countries	11
<b>Table 6</b> Slaughter yields of different rabbit breeds and crosses at 10 to 12 weeks, in Belgium	13
<b>Table 7</b> Slaughter yield of New Zealand Whites, by age	14
<b>Table 8</b> Effect of feed type on slaughter yield: role of supplementary bulk feed	14
<b>Table 9</b> Impact of balanced feed on slaughter yield of Fauve de Bourgogne rabbits	14
<b>Table 10</b> Meat composition of different animal species	15
<b>Table 11</b> Proportion of the principal fatty acids in fat deposits of different animal species	15
<b>Table 12</b> Changes in hindleg muscle tissue composition in New Zealand Whites, according to age	16

---

---

<b>Table 13</b>	
Water losses from grilling rabbit meat, according to age and fat content	16
<hr/>	
<b>Table 14</b>	
Composition of hard and soft faeces: averages and range for ten different feeds	22
<hr/>	
<b>Table 15</b>	
Intake and excretion of dry matter by growing rabbits eating isonitrogenous feeds containing two levels of straw in place of maize starch	22
<hr/>	
<b>Table 16</b>	
Chemical composition of different raw materials suitable for feeding rabbits	23
<hr/>	
<b>Table 17</b>	
Changing feed habits of nine New Zealand White male rabbits aged from 6 to 18 weeks, given water and balanced feed ad lib in a room kept at 20±1°C	24
<hr/>	
<b>Table 18</b>	
Changing feed and water intakes of growing rabbits in changing temperatures	27
<hr/>	
<b>Table 19</b>	
Impact of ambient temperature on intake and excretion ratios in adult rabbits	27
<hr/>	
<b>Table 20</b>	
Impact of drinking-water salinity on rabbit growth performance	27
<hr/>	
<b>Table 21</b>	
Feed intake and growth of New Zealand White rabbits aged between five and nine weeks, receiving ad lib a concentrated feed rich or poor in fibre, with and without wheat-straw pellets 5 mm in diameter	28
<hr/>	
<b>Table 22</b>	
Recommended chemical composition of feeds for intensively reared rabbits of different categories	30
<hr/>	
<b>Table 23</b>	
Decline in performance at levels of protein or selected essential amino acids in the feed below recommended values, and minimum acceptable levels	33
<hr/>	
<b>Table 24</b>	
Recommended limits for the incorporation of various minerals, vitamins and selected amino acids in rabbit feed	35
<hr/>	

---

<b>Table 25</b> Influence of pellet diameter on growth of Californian rabbits aged from 5 to 12 weeks	36
<b>Table 26</b> Effect of presentation of feed on growth of young rabbits, according to various authors	36
<b>Table 27</b> Average composition of cow's and rabbit's milk	55
<b>Table 28</b> Characteristics of selected INRA experimental strains	67
<b>Table 29</b> Performance of females of three genetic types in Guadeloupe rabbitries	68
<b>Table 30</b> Average breeding parameters of four breeds raised at the Irapuato National Rabbit Breeding Centre, Mexico	68
<b>Table 31</b> Litter size observations in Cuba for four rabbit breeds	68
<b>Table 32</b> Summary of selected breed comparisons for individual weight at weaning, individual weight at x weeks, litter size at birth and at weaning	70
<b>Table 33</b> Litter size components in three experimental INRA strains	71
<b>Table 34</b> Litter size components in a sample of 233 V-strain females at the University of Valencia	71
<b>Table 35</b> Variability in weights of young rabbits from 28 to 78 days, and carcass weights, for two breeds	72
<b>Table 36</b> Average live weight at 84 days, carcass weight, muscle weight/bone weight ratio, weight of fatty tissue in carcass, for three breeds	72
<b>Table 37</b> Birth-weaning viability of young rabbits by litter size at birth	74

---

---

<b>Table 38</b> Comparison of three reproduction rates	75
<b>Table 39</b> Allometric coefficients of the main organs and tissues and indication of critical body weights (less digestive content) observed in male rabbits	76
<b>Table 40</b> Average female performances in nine genotypes: litter size components measured at different stages	80
<b>Table 41</b> Genetic parameters of litter size measured at different stages between ovulation and weaning	80
<b>Table 42</b> Adult live weight of four breeds in a Cuban cross-breeding experiment, 1969 to 1971	82
<b>Table 43</b> Distribution of the effects of direct and maternal heterosis in a series of cross-breeding experiments in Egypt	82
<b>Table 44</b> Four selection techniques compared for effectiveness	86
<b>Table 45</b> Findings of specific selection experiments on rabbits	87
<b>Table 46</b> Formation of reproduction groups based on family origin	88
<b>Table 47</b> A four-strain cross-breeding experiment	90
<b>Table 48</b> Comparative pathogenic strengths of different intestinal coccidia of the rabbit	101
<b>Table 49</b> Exportation of heat, rectal temperature and ear temperature in adult New Zealand White rabbits, according to ambient temperature	128
<b>Table 50</b> Ventilation standards in France for enclosed rabbitries	130

---

---

<b>Table 51</b>	
Brightness of various types of lighting	132
<hr/>	
<b>Table 52</b>	
Cage sizes for breeding animals in France	134
<hr/>	
<b>Table 53</b>	
Influence of animal density on fattening rabbits	134
<hr/>	
<b>Table 54</b>	
Average composition of excrement collected under wire-mesh cages of rabbits receiving balanced concentrates	147
<hr/>	
<b>Table 55</b>	
Quantities and composition of excrement produced by different categories of rabbit	147
<hr/>	
<b>Table 56</b>	
Example of weekly work plan	161
<hr/>	
<b>Table 57</b>	
Annual production performance in France from 1983 to 1992 in rabbitries monitored under technico-economic management	162
<hr/>	
<b>Table 58</b>	
Cost schedules in French production units as a percentage of annual turnover: averages and values for the upper and lower thirds of rabbitries classified by doe productivity	163
<hr/>	
<b>Table 59</b>	
Influence of various factors on income of a French production unit	163
<hr/>	





---

# Figures

---

<b>Figure 1</b>		
Estimate of annual production of rabbit carcasses in different countries		<b>6</b>
<hr/>		
<b>Figure 2</b>		
The digestive system of the rabbit		<b>20</b>
<hr/>		
<b>Figure 3</b>		
Hourly distribution of daily intake of water and balanced pelleted feed of a 12-week-old rabbit over a period of 24 hours		<b>25</b>
<hr/>		
<b>Figure 4</b>		
Changing intake of balanced concentrate feed in a doe during gestation and lactation		<b>26</b>
<hr/>		
<b>Figure 5</b>		
Role of fibre intake in the health of fattening rabbits		<b>34</b>
<hr/>		
<b>Figure 6</b>		
Weight-gain trends in New Zealand White rabbits aged from 6 to 14 weeks in relation to intake of balanced feed		<b>41</b>
<hr/>		
<b>Figure 7</b>		
Genital apparatus of male rabbit		<b>46</b>
<hr/>		
<b>Figure 8</b>		
Genital apparatus of female rabbit		<b>47</b>
<hr/>		
<b>Figure 9</b>		
Sexual behaviour and duration of oestrus in five pubescent nulliparous does		<b>49</b>
<hr/>		
<b>Figure 10</b>		
Mating acceptance trends in gestating does		<b>50</b>
<hr/>		
<b>Figure 11</b>		
Onset of ovulation following coitus		<b>51</b>
<hr/>		
<b>Figure 12</b>		
Changing weights of foetus and embryonic membranes during gestation		<b>52</b>
<hr/>		
<b>Figure 13</b>		
Pattern of milk production in does		<b>56</b>

---

---

<b>Figure 14</b> Changing live weights of young does aged from 37 to 112 days reared in different temperatures	57
<b>Figure 15</b> Seasonal variation in percentage of gestating and/or lactating wild does in the United Kingdom	58
<b>Figure 16</b> Distribution of gestation, lactation and resting periods in does used at different rates of reproduction	60
<b>Figure 17</b> Respective genetic roles of male and female rabbits in determining litter size at weaning	73
<b>Figure 18</b> Heritability and genetic correlation of production characters in rabbits	77
<b>Figure 19</b> Constitution of generation $n + 1$ groups, the progeny of $n$ generation breeding groups	89
<b>Figure 20</b> Pyramidal scheme for creating and disseminating genetic progress in rabbits	92
<b>Figure 21</b> Use of different strains in a pyramidal scheme	93
<b>Figure 22</b> The clinical evolution of coccidiosis	103
<b>Figure 23</b> Development of coccidiosis	105
<b>Figure 24</b> Effect of air speed and temperature on health of rabbits	131
<b>Figure 25</b> Estimating air flow with a candle flame	131
<b>Figure 26</b> Examples of correct and incorrect cage assembly, fostering good hygiene and resistance	135
<b>Figure 27</b> Swinging rear wall in concrete hutch for waste removal	136

---

---

<b>Figure 28</b>		
Four systems for using wire cages		137
<hr/>		
<b>Figure 29</b>		
Inverted water-bottle drinker		138
<hr/>		
<b>Figure 30</b>		
Automatic drinkers		139
<hr/>		
<b>Figure 31</b>		
Drinker made from a nipple in plastic bottle and clay drinker used as inverted water bottle		139
<hr/>		
<b>Figure 32</b>		
Feed hopper		140
<hr/>		
<b>Figure 33</b>		
Design for a nest box		141
<hr/>		
<b>Figure 34</b>		
Outdoor wooden cage		143
<hr/>		
<b>Figure 35</b>		
Wire-mesh cages under a common roof		143
<hr/>		
<b>Figure 36</b>		
Rational enclosure for rabbitries		145
<hr/>		
<b>Figure 37</b>		
Two-zone cage: wire-mesh and underground		146
<hr/>		
<b>Figure 38</b>		
Production cycle of the domestic rabbit		150
<hr/>		
<b>Figure 39</b>		
Castration of young male rabbit		154
<hr/>		
<b>Figure 40</b>		
Correct way to pick up a rabbit		155
<hr/>		
<b>Figure 41</b>		
Holding a young rabbit head down		155
<hr/>		
<b>Figure 42</b>		
Carrying a large rabbit, supporting its hindquarters		156

---

<b>Figure 43</b> Technique of carrying a rabbit on the forearm	<b>156</b>
<b>Figure 44</b> Using a clipper with movable numbers to tattoo the identification number on a rabbit's ear	<b>157</b>
<b>Figure 45</b> Example of a doe card	<b>158</b>
<b>Figure 46</b> Example of a buck card	<b>159</b>
<b>Figure 47</b> Diagram of planning pigeonholes	<b>160</b>
<b>Figure 48</b> Skinning a rabbit	<b>170</b>
<b>Figure 49</b> Correct way to dry rabbit pelts	<b>171</b>
<b>Figure 50</b> Comparative growth of hair types in Angora and common rabbits	<b>175</b>
<b>Figure 51</b> Example of leaflet circulated in Mexico for the promotion of rabbit production	<b>187</b>
<b>Figure 52</b> Example of worksheet used for selecting does according to numerical productivity	<b>191</b>
<b>Figure 53</b> Example of cross-breeding based on three genetic types at Irapuato	<b>192</b>
<b>Figure 54</b> Global analysis of a development programme using rabbits	<b>197</b>

---

# Colour plates

(inserted after page 124)

---

**1**

New Zealand White rabbit

---

**2**

Bouscat Giant White rabbit

---

**3**

French Belier rabbit

---

**4**

Californian rabbit

---

**5**

Dutch Belted rabbit

---

**6**

French Giant Papillon rabbit

---

**7**

Vienna Blue rabbit

---

**8**

Flemish Giant rabbit

---

**9**

Creole (Guadeloupe) rabbits

---

**10**

A "family package" of bucks and breeding does supplied by a Mexican programme

---

**11**

Wooden hutches with mesh floors arranged in a two-storey system (Guadeloupe)

---

**12**

Open drinkers supplied semi-automatically from a fitted bucket (Guadeloupe)

---

**13**

Fattening cages built entirely in wire mesh, placed outside in superimposed rows (France)

---

**14**

Cages arranged in a plastic greenhouse, protected with a reed lattice (France)

---

**15**

Exterior of the same greenhouse, photographed in winter

---

**16**

Fattening cages for rabbits in a greenhouse with a makeshift floor

---

**17**

Italian system for arrangement of fattening cages

---

**18**

Mesh cages arranged by the Californian system (France)

---

**19**

Breeding cages with forward nest box in a modern French rabbitry

---

**20**

Cages for the collection and transport of rabbits to the abattoir (Hungary)

---

**21**

Plastic cages for trucking rabbits from the rabbitry to the abattoir

---

**22**

Rabbitry in Cameroon. Recycling cages for laying hens in a semi-Californian arrangement

---

**23**

Health-care room at the Solambé Demonstration Centre, Yaoundé, Cameroon

---

**24**

Rabbitry with semi-underground cages: overall view

---

**25**

Rabbitry with semi-underground cages: unit

---

**26**

Faeces from rabbits receiving feed with a normal proportion of roughage, slightly deficient and deficient in roughage but without diarrhoea

---

---

## Acknowledgements

*Much of the information contained in this book comes from work and research conducted by its authors and their colleagues in the National Institute for Agricultural Research (INRA) in France. The authors feel it only fair to mention the names of those colleagues with whom they work daily and from whom they have "borrowed" an amount of data.*

- *Animal Genetics Improvement Station, Toulouse Centre: R. Rouvier, B. Poujardieu, G. Bolet, A. Roustan, J.-M. Brun, F. Tudela*
- *Rabbit-breeding Research Laboratory, Toulouse Centre: J. Ouhayoun, T. Gidenne, J.-M. Perez, F. Hulot, L. Fortun, D. Delmas*
- *Rabbit Pathology Laboratory, Tours Centre: D. Licois, F. Viard*
- *Magneraud Pluridisciplinary Unit, Poitou-Charentes Centre: P. Mercier*
- *Animal Physiology Station, Jouy-en-Josas Centre: B. Moret*
- *INRA Special Committee on Rabbits, Poitou-Charentes Centre: J.-L. Vrillon*

*The authors also wish to thank Mr Kpodekon, Rabbit Research and Data Centre, Cotonou University, Benin, for his contribution to this book.*





## Chapter 1

# Introduction and background

### WORLD PRODUCTION AND TRADE

Best known for being prolific, rabbits are also herbivores which efficiently convert fodder to food. The whole point of meat production is to convert plant proteins of little or no use to people as food into high-value animal protein.

In efficient production systems, rabbits can turn 20 percent of the proteins they eat into edible meat. Comparable figures for other species are 22 to 23 percent for broiler chickens, 16 to 18 percent for pigs and 8 to 12 percent for beef.

A similar calculation for the energy cost of these proteins is even more unfavourable to ruminants, as shown in Table 1. When cattle or sheep are raised for meat production, most of the energy consumed by the herd or flock is used to maintain breeding females which have a low prolificacy: a maximum of 0.8 to 1.4 young per year against 40 for female rabbits. Even with the theoretical lower energy cost when cattle are raised for both milk and beef, rabbit meat is still more economical in terms of feed energy than beef. Rabbit meat production is therefore an attractive proposition, especially when the aim is to produce quality animal protein.

Rabbits can also easily convert the available proteins in cellulose-rich plants, whereas it is not economical to feed these to chickens and turkeys – the only animals with higher energy and protein efficiency. The traditional grain and soycakes fed to these domestic poultry put them in direct competition with humans for food. For countries with no cereal surpluses, rabbit meat production is thus especially interesting.

### HISTORICAL BACKGROUND

#### A little history

The domestication of the major livestock species (cattle, sheep, pigs) and the small species (poultry) is lost in the dawn of prehistory. But rabbit domestication dates back no further than the present millennium.

Indeed, the wild rabbit *Oryctolagus cuniculus* of southern Europe and North Africa is thought to have been discovered by Phoenicians when they reached the shores of Spain about 1000 BC. In Roman times the rabbit was still emblematic of Spain. The Romans apparently spread the rabbit throughout the Roman Empire as a game animal. Like the Spaniards of that time, they ate foetuses or newborn rabbits, which they called *laurices*.

Rabbits had still not been domesticated, but Varron (116 to 27 BC) suggested that rabbits be kept in *leporaria*, stone-walled pens or parks, with hares and other wild species for hunting. These *leporaria* were the origin of the warrens or game parks that subsequently developed in the Middle Ages. It is known that monks were in the habit of eating *laurices* during Lent as they were considered “an aquatic dish” (*sic*). In France, it became the sole right of the lord of the manor to keep warrens. Rabbits were hunted little, and were captured with snares, nooses or nets.

Several breeds of rabbit were known in the sixteenth century and this is the first indication of controlled breeding. Domestication can therefore be traced to the late Middle Ages. This was probably mainly the work of monks, since it provided them with a more delectable dish than the tougher wild rabbit.

TABLE 1

**Average performance of different animal species and energy cost of proteins they produce**

	No. of young per breeding female per year	Live weight of breeding female (kg)	Live weight at slaughter (kg)	Slaughter yield (%)	Daily weight increase		Fat content of carcass (%)	Food kcal per g of usable protein (kcal/g)
					(g)	g/khW <sup>0.75</sup>		
Broilers	100	3.0	2.0	63	31	30.5	13.0	80
Turkeys	60	10	10.1	79	65	19.2	13.0	87
Rabbits	40	4.5	3.2	60	32	22.3	6.8	105
Pigs	12	170	100	73	540	28.4	32.0	151
Sheep	1.4	70	50	50	220	18.2	36.0	427
Beef cattle	0.8	500	475	61	950	14.8	32.0	442
Dairy cattle*	0.8	500	475	61	950	14.8	32.0	184

**Note:** Performance levels noted by Dickerson for each species are not peaks, but fall within the easy range of most breeders.  
\* Theoretical calculation for beef production of a dairy cattle breed, arbitrarily assigning total reproduction and maintenance costs of adult animals to milk production, retaining only feed portion consumed by slaughter animal, i.e. 43.6 percent of total energy expenditure.

Source: Dickerson, 1978.

During the sixteenth century breeding seems to have spread across France, Italy, Flanders and England. In 1595, Agricola mentioned the existence of grey-brown (wild), white, black, piebald (black and white) and ash-grey rabbits. In 1606, Olivier de Serres classified three types of rabbit: the wild rabbit, the semi-wild or "warren" rabbit raised inside walls or ditches, and the domesticated or hutch-bred rabbit. The meat of the last is described as insipid and that of the wild or semi-wild type as delicate.

At the beginning of the nineteenth century, after the abolition of seigneurial privileges, rabbit rearing in hutches sprang up all over rural western Europe and also in city suburbs. European colonial expansion saw the introduction of the rabbit in many countries where it was unknown, such as Australia and New Zealand.

In Europe, breeders usually had a few does and a stock of fattening animals, from which they took according to their needs, as from a larder. The animals were fed mainly on green forage picked daily. In winter the breeders supplemented forage

with hay, beetroots and even grains, often from stocks intended for large livestock. Rabbits were kept in the backyard, with the poultry. Reproduction was extensive (two or three litters a year).

From that time on there is frequent mention of the fur as a by-product (the breed now called Argenté de Champagne was described as "rich"), and the already long-existing Angora mutant was recorded.

#### From backyard to rational production

Beginning in the late nineteenth century and picking up speed in the twentieth, hutch rearing led to a rabbit population explosion made possible by the selection, protection and multiplication of breeds and mutants unadapted to the wild. Breeders formed associations. Breeding techniques were rationalized and hutch hygiene improved.

Breeding standards were laid down: each adult breeding animal was raised in a separate hutch because rabbits kept in a confined space became aggressive. Young rabbits for fattening were left together, but in this case the males were castrated. Feeding

was the same as in the previous century, green fodder and grains, but the first feeding trials produced certain guidelines. The Second World War saw the extensive development of rabbit production throughout Europe and Japan to cope with meat shortages. Under these demanding conditions, rabbits demonstrated their highly efficient feed-conversion capacity.

In the 1950s, production slumped in Japan and the northern European countries as other meats with more flavour became available, such as frozen beef from the Southern Hemisphere. But in the Latin countries of Europe where people know how to cook rabbit, particularly in France, rabbits were still produced. In the late 1950s, New Zealand rabbits, wire-mesh cages and balanced pelleted feeds were all introduced into France and Italy from the United States. At the same time, diseases hitherto unknown and apparently linked with the new production techniques (mucoid enteritis and respiratory ailments) appeared and others disappeared (cenuriasis) or tapered off (coccidiosis).

These new techniques, originally better adapted to the climate of California than to that of northern Italy or France, demanded many modifications in production which were often discovered by trial and error. The hutches especially, which had always been kept outside, were put in closed buildings. Ventilation and lighting problems had to be solved.

The time spent on cleaning cages and collecting food was reduced abruptly. This freed breeders to spend more time on the animals themselves. In the late 1960s and early 1970s, the work of authors such as Prud'hon *et al.* (1969) led to a sharp drop in weaning age, from eight to four weeks. Postkindling matings replaced postweaning matings. Breeders were able to put into practice Hammond and Marshall's early observations (1925) about postkindling fertilization of does because feeds were so much im-

proved as to obviate the danger of abortion in lactating pregnant does through malnutrition.

At the same time came the explosion of the New Zealand White rabbit and its offshoot, the Californian rabbit. The traditional European breeds (Fauve de Bourgogne, Argenté de Champagne, French Belier) underwent a regression. As adults it is difficult for these breeds to live on the mesh floors of the cages – the pads of their paws not being adapted like those of the New Zealand White and Californian rabbits.

French and Italian breeders worked to improve substantially the first New Zealand White and Californian rabbits imported from the United States. In France, the two breeds were combined to produce specialized hybrid strains according to the design conceived by the French National Institute for Agricultural Research (INRA). In the late 1970s, these strains crossed the French border to Italy, Spain, Belgium and the Federal Republic of Germany where, in large commercial production units, they tended to supplant the traditional breeds. Other hybrid strains were produced at the same time, especially in Hungary and the United Kingdom, but in almost every case the new strains were bred from these original two breeds.

Traditional varicoloured rabbits have been gradually replaced by white rabbits. This is having a considerable impact on the market for skins. Before the 1970s, furriers tended to favour the easy-to-dye white skins. Today the reverse is true – white skins are too common. At the same time, improved production techniques have lowered the slaughter age of rabbits in Europe which has reduced the value of the fur. The hair of the skins is "loose" because the animals are too young.

Production trends in France since the 1950s are given in Table 2. Industrial rabbit production (specialists prefer the word

TABLE 2  
Production trends in France from 1950 to 1990 in the most productive rabbitries

Criteria	1950	1960	1970	1980	1990
Rabbits produced (sold) per breeding doe	20-25	30	45	60	65
Average interval between litters (days)	90-100	70	54	42	40
Concentrate feed necessary to produce 1 kg live rabbit (kg)	(*)	6	4.5	3.6	3.3
Type of rabbit	Common, of no specific breed	Pure breeds	Pure-bred does crossed with improver buck	Specialized hybrid strains	Specialized hybrid strains
Working hours per doe per year (hours)	16	16	10	7.5	6.0
Labour used to produce 1 kg carcass (minutes)	27	22	9.5	6.2	4.3
Number of breeding does in breeding units	80-100	100-150	200-250	350-400 up to 1 000	600-4 000
Percentage of investment in retail price of rabbit (%)	<3	5-8	12-15	18-20	18-20

\* Rabbits were not fed concentrates at this date.

“rational” to industrial, as the breeder’s expertise is still very important) in Europe today is typically in units of 200 to 1 000 hybrid does reared in buildings with artificial or controlled ventilation. The breeding females are under artificial lighting for 15 to 16 hours a day and produce all through the year. All animals are reared in one- to four-storey mesh cages (flat-deck and battery). Male and female breeding animals are raised in cages in groups of five to ten (France and Spain) or one to three (Italy). Young males are not castrated because they are sold for slaughter before or just at puberty. All the animals are fed exclusively with balanced pelleted feed. Drinking water is automatically distributed to every cage.

At the same time there is a sizeable increase in private (sophisticated buildings and breeding installations) and producer-group investments (technical advisers).

Typically, rational production consists of a very quick succession of all phases of the reproduction cycle. This demands extremely close and time-consuming supervision by the breeder. The technical adviser, not being directly involved in these day-to-day tasks, is of great assistance in the medium- and long-term running of a unit. His/her salary and ancillary costs amount to a sizeable investment for a group of producers (1 to 3 percent of the sale price of a rabbit).

In many countries of Eastern and Western Europe (e.g. Poland, Hungary, France, Italy and Belgium), a more traditional production system, very similar to that of the first 40 or 50 years of this century, still contributes a considerable part of the national output: over 90 percent in Hungary and nearly 40 percent in France. These traditional units are usually very small, with two to 12 breeding females.

### WORLD PRODUCTION

National statistics do not generally include rabbit production, but a few available basic statistics allowed Lebas and Colin (1992) to estimate a world output of roughly 1.2 million carcasses. A more recent estimate (1994) by the same authors, including almost all countries in the world, suggests a possible 1.5 million tonnes. This would mean a per caput annual consumption of roughly 280 g of rabbit meat; a theoretical figure in that most inhabitants in a great many countries consume no rabbit meat whatsoever against the 10 kg/year consumed by French farmers and 15 kg/year per caput in Naples, Italy. Europe is indeed the centre of world rabbit production (Figure 1). The foremost world producers, far surpassing all other countries, are Italy, the Commonwealth of Independent States (CIS) countries (particularly Russia and the

Ukraine), France, China and Spain (Table 3). In all, Europe accounts for 75 percent of world production. China is second, specifically certain central Chinese provinces such as Szechuan. Production areas are also found in some regions of Africa, Central America and Southeast Asia, particularly Indonesia. Rabbits are not reared in most countries of the Near East. Table 4 gives some indication of per caput consumption.

### European trends, 1960 to 1980

Rabbit production in Italy was still traditional in the early 1970s. However, faced with as strong a demand for the product in the industrialized north as in the more traditional south, production units mushroomed between 1975 and 1990. The greatest concentration and largest rabbitries are found in the Venice area, but production is also substantial throughout the country.

TABLE 3  
Major rabbit-producing countries in 1990\*

Country	Estimated production (carcass weight)	Country	Estimated production (carcass weight)
	<i>Thousands of tonnes</i>		<i>Thousands of tonnes</i>
Italy	300	Portugal	20
CIS (former USSR)	250	Morocco	20
France	150	Thailand	18
China	120	Viet Nam	18
Spain	100	Philippines	18
Indonesia	50	Romania	16
Nigeria	50	Mexico	15
United States	35	Egypt	15
Germany	30	Brazil	12
Czechoslovakia (former)	30		
Poland	25	<b>Total 22 major producers</b>	<b>1 311</b>
Belgium	24	Other countries	205
Hungary	23	<b>Total estimated world production</b>	<b>1 516</b>

\* Countries producing more than 10 000 tonnes.  
Sources: Lebas and Colin, 1992; Colin and Lebas, 1994.

**FIGURE 1**  
 Estimate of annual production of rabbit carcasses in different countries  
 (dead weight in thousands of tonnes)

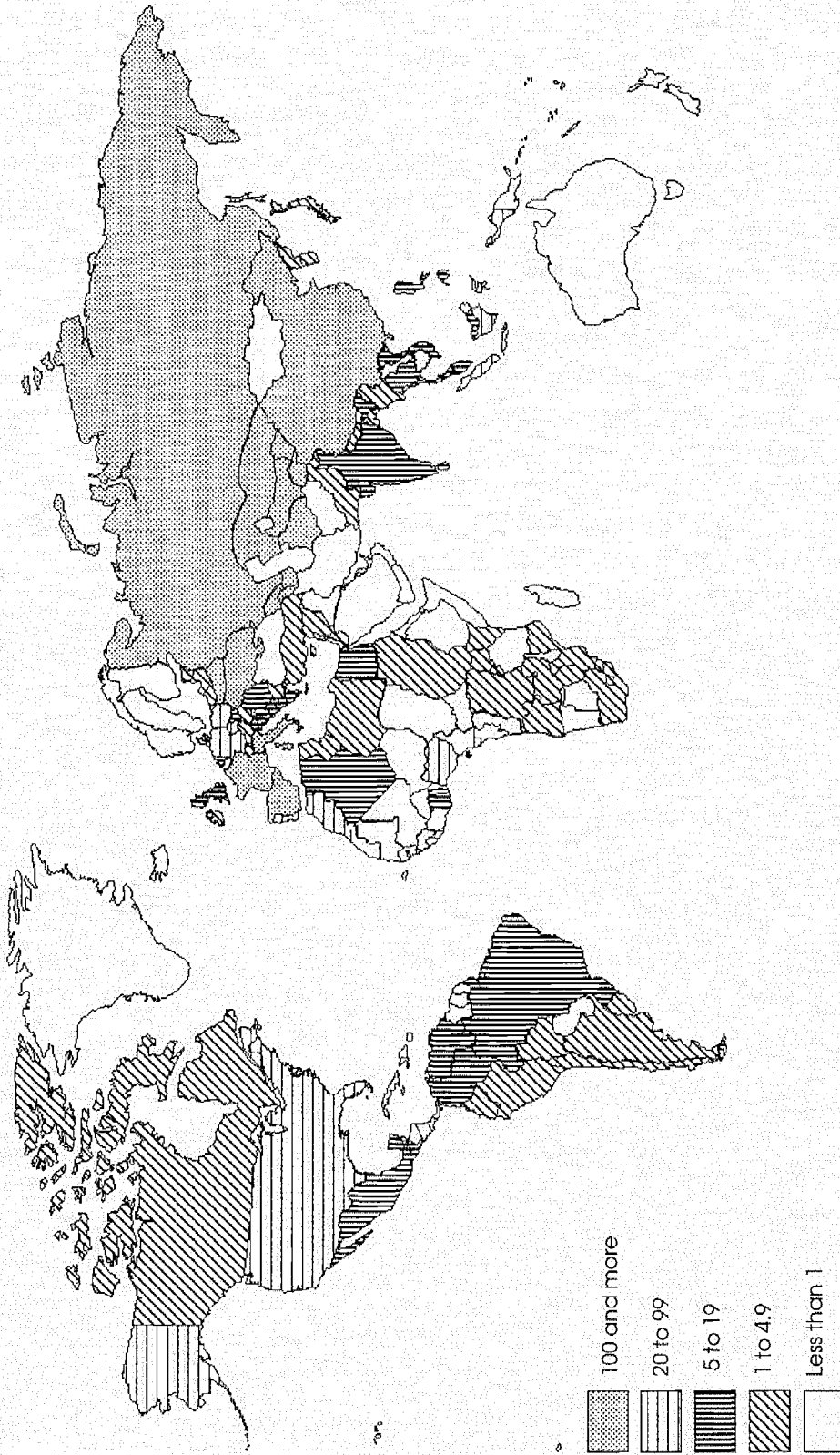

Source: INRA-FAO survey, 1991; Colin and Lebas, 1994.

## Database

**Countries producing 100 000 tonnes or more**

China  
 CIS (former USSR)  
 France  
 Italy  
 Spain

**Countries producing 20 000 to 99 000 tonnes**

Belgium  
 Czech Republic  
 Germany  
 Hungary  
 Indonesia  
 Morocco  
 Nigeria  
 Poland  
 Portugal  
 United States of America

**Countries producing 5 000 to 19 000 tonnes**

Algeria  
 Brazil  
 Colombia  
 Denmark  
 Egypt  
 Ghana  
 Greece  
 India  
 Malaysia  
 Mexico  
 Netherlands  
 Philippines  
 Romania  
 Slovakia  
 Sri Lanka  
 Thailand  
 United Kingdom  
 Venezuela  
 Viet Nam  
 Yugoslavia (former)

**Countries producing 1 000 to 4 900 tonnes**

Albania  
 Angola  
 Argentina  
 Bangladesh  
 Bolivia  
 Bulgaria  
 Burundi  
 Canada  
 Chile  
 Côte d'Ivoire  
 Democratic People's Republic of Korea  
 Democratic Republic of the Congo  
 (former Zaire)  
 Ecuador  
 Estonia  
 Ireland  
 Japan  
 Jordan  
 Kenya  
 Latvia  
 Libyan Arab Jamahiriya  
 Lithuania  
 Malta  
 Mozambique  
 Myanmar  
 Nepal  
 Pakistan  
 Peru  
 Puerto Rico  
 Republic of Korea  
 Rwanda  
 South Africa  
 Sudan  
 Switzerland  
 Syrian Arab Republic  
 Tunisia  
 Turkey  
 Uruguay  
 Zambia  
 Zimbabwe

**Countries producing less than 1 000 tonnes**

All other countries

TABLE 4  
**Estimated annual consumption of rabbit meat by country**  
 (in kg per inhabitant)

Country	Weight	Country	Weight
Malta	8.89	Venezuela	0.30
Italy	5.71	Philippines	0.29
Cyprus	4.37	Egypt	0.27
France	2.76	Indonesia	0.27
Belgium	2.73	Algeria	0.27
Spain	2.61	Viet Nam	0.27
Portugal	1.94	Syrian Arab Republic	0.25
Czechoslovakia (former)	1.72	Colombia	0.24
CIS (former USSR)	0.75	Canada	0.23
Morocco	0.78	Jamaica	0.20
Slovenia	0.77	Mexico	0.18
Greece	0.70	United States	0.14
Romania	0.64	Argentina	0.12
Netherlands	0.63	South Africa	0.11
Malaysia	0.50	Hungary	0.10
Poland	0.50	Brazil	0.08
Tunisia	0.48	China	0.07
Nigeria	0.45	Benin	0.04
Germany	0.44	Democratic Republic of the Congo (former Zaire)	0.04
Bulgaria	0.39	Japan	0.03
Ghana	0.32		
Thailand	0.31		

Source: Lebas and Colin, 1992; Colin and Lebas, 1994.

Global production rose from roughly 120 000 tonnes in about 1975 to nearly 300 000 tonnes in 1990.

The situation in France is somewhat different. Output stabilized at about 275 000 tonnes a year from 1965 to 1972, then slumped abruptly and now stands at roughly 150 000 tonnes. This situation is in line with the rapid drop in the number of very small producers who consumed much of their own production but who, because there were so many of

them, supplied an appreciable share of the rabbits marketed. During the same period many newly established rational units of 50 to 500 did not only close the small-scale producer gap, but also managed to increase slightly the tonnage of rabbits marketed, which rose from 80 000 to 90 000 tonnes in the years 1960 to 1965 to 100 000-110 000 tonnes at present. A considerable research effort aimed at improving production techniques was responsible for this increase.



The traditional production sector in Spain produced little during the 1960s. The many rational units that were opened from 1970 onwards led to a spectacular leap in the output and marketing of rabbit meat. The present total is 100 000 tonnes. Production models were transposed directly from France.

Lagging about 15 years behind Spain, Portugal developed rational production incorporating the progress made in French, Italian and Spanish rabbitries. Portugal, with an annual per caput carcass output of 2 kg, is on a par with Belgium for volume of production: 24 000 tonnes per year.

Rabbit meat production and consumption in other Western European countries are still low. However, there seems to be a slight upturn in Germany, where breeders are being encouraged to increase their output. There is a large number of fancy breeders in Germany who raise a few pedigree animals as a hobby and also eat a small proportion of the rabbits produced for this purpose. Production and consumption in Sweden and Norway are very low. Rabbit breeding is still a tradition in Denmark, although the national output, once mostly exported to Germany, has now dropped.

Hungary stands out among Eastern European countries. This predominantly agricultural country encourages family-scale rabbit production with five to 20 does. At the same time, the large production complexes with 10 000 to 15 000 breeding females established in the 1970s and 1980s have been abandoned because of management problems. They have been downsized and serve primarily to supply selected breeders for small-scale operations. The young fattened animals produced on family farms are collected and almost all exported to Italy. In the early 1970s exports to Italy consisted mainly of live animals. The rabbits were slaughtered in the Milan area. Most rabbits from Hungary are now exported as fresh carcasses. In Poland, small

family rabbitries (five to 20 breeding females) are still the rule. The rabbits produced are expected to provide good-quality meat as well as fur for marketing. Therefore they are usually slaughtered late (four to six months) for better skin quality. Some animals are collected as in Hungary, but exported as frozen carcasses (generally heavy). The sizeable Czechoslovakian production is mainly for national consumption but, as in Germany, there are many (80 000-90 000) fancy breeders raising a few pedigree rabbits as a hobby.

#### North and South America

Rabbit production and consumption in the United States are concentrated primarily in the three Pacific States and in the southern States of Missouri and Arkansas. A frequent estimate of national output is 15 000 to 17 000 tonnes, but an updated review by Colin (1993) suggests the figure may be as high as 35 000 tonnes. Young rabbits of approximately 1.8 kg live weight are eaten as "fryers". On the east coast there is virtually no market and the only rabbits are pets.

Rabbit production in Canada is modest, mainly concentrated in the provinces of Quebec and Ontario, where it is subsidized by the provincial governments. The slaughtered carcasses are a little heavier than in the United States.

In Mexico, the promotion of backyard rabbitries in rural and peri-urban areas has led to a total annual output of 10 000 tonnes, from these small units, producing mainly for home consumption, and commercial units combined. The latter are small (20 to 100 does) and use balanced concentrate feeds almost exclusively. The family units rely on forage (alfalfa, maize or sorghum stems) and kitchen wastes. This rabbitry, unfortunately decimated by viral haemorrhagic disease (VHD) in 1990, is now being rehabilitated.

In the Caribbean area, rabbit production is basically family style and forage-based.

The rabbits are often small local breeds descended from animals imported some tens or hundreds of years ago. However, notable efforts have been made in Cuba to develop improved breeds and use more intensive production methods. In Guadeloupe and Martinique in the French Antilles, intensive commercial production in small units of 25 to 100 does has grown side by side with traditional production in the last decade. This development is based on animals and concentrate feeds imported from France or produced locally. Performance is good: does produce 30 to 40 young a year and these are sold at 2.2 to 2.4 kg at about 80 days.

In South America the biggest producers are Brazil and Uruguay, in large commercial units with thousands of breeding females. The animals, generally raised extensively, are fed locally manufactured balanced concentrate feeds.

#### Asia

Rabbit production does not seem to have truly developed in Asia except in Indonesia and, particularly, China. The Philippines, Malaysia, Thailand, Viet Nam and the Republic of Korea also produce a small amount of rabbits. No official statistics are published in China on the production and consumption of rabbit meat and it is difficult to approach the question of production in a country of a thousand million inhabitants without official statistics. However, it does appear that rabbits for export (mainly to Europe) come from the nearly 20 million Angora rabbits produced. They are usually slaughtered very young, after the second or third clipping at most. Production is mixed: angora wool plus meat. Thus, financially, meat appears to be the by-product and angora wool the main product, fetching 55 to 70 percent of the return for each animal. The animals are fed forage and a little grain and grain by-products. Production units do not appear

to be spread throughout China, but rather concentrated in certain villages. This enables better support facilities and facilitates the marketing of a product which remains, in principle, traditional. In other Chinese provinces, such as Szechuan, there is substantial production of meat rabbits intended primarily for local consumption. Part is, in any case, collected for export to hard-currency countries.

#### Africa

There is a tradition of rabbit production in the five Mediterranean countries of Africa. Per caput production varies from Egypt's 0.27 kg to Morocco's nearly 0.78 kg. The traditional production systems in the southern parts of these regions feature an original habitat where rabbits are group-reared in burrows dug into the earth.

In sub-Saharan Africa, the two main producers are Nigeria and Ghana and to a lesser extent the Democratic Republic of the Congo, Cameroon, Côte d'Ivoire and Benin.

There is commercial production in these countries, but most rabbitries are family-owned, with part of the output for market. The national rabbit production development programme in Ghana, for example, proposes a system where small family units keep only three to six breeding animals, so they can be fed on local products – forage, cassava, etc. – and produce surplus animals for sale.

#### INTERNATIONAL TRADE

##### The rabbit meat market

Few countries are involved in the international trade: the annual trade figure is over 1 000 tonnes of carcass equivalent. Only nine countries are exporters, only six are importers and eight are both.

The actual volume of international trade is quite small: 6 or 7 percent of world output, according to the data source in Table 5. A total of 23 countries account for 95 per-

TABLE 5  
**Major rabbit meat importing and exporting countries**  
(in millions of tonnes of carcass equivalent per year)

Country	Exports	Imports	Balance
Austria	0	1.0	- 1.0
Belgium	10.3	13.0	- 2.7
Canada	1.0	3.0	- 3.0
China	40.0	0	+ 40.0
Croatia	1.0	0	+ 1.0
Czechoslovakia (former)	3.0	0	+ 3.0
France	5.0	11.0	- 6.0
Germany	0	5.0	- 5.0
Hungary	22.7	0.7	+ 22.0
Italy	0.65	30.0	- 29.35
Japan	0	3.0	- 3.0
Mexico	0	3.0	- 3.0
Netherlands	3.75	3.70	+ 0.05
Poland	6.0	0	+ 6.0
Republic of Korea	0	1.2	- 1.2
Romania	1.0	0	+ 1.0
Serbia	1.5	0	+ 1.5
Singapore	0	1.0	- 1.0
Spain	0.5	2.5	- 2.0
Sri Lanka	0	1.0	- 1.0
Switzerland	0	5.0	- 5.0
United Kingdom	0.2	9.0	- 8.8
United States	2.0	3.0	- 1.0
<b>Total</b>	<b>94.1</b>	<b>97.6</b>	
<b>Total world trade</b>	<b>100</b>	<b>100</b>	

Source: Colin and Lebas, 1994.

cent of the international trade (imports and exports alike), implying that rabbit meat production is generally for domestic consumption.

The two biggest exporting countries are China (40 000 tonnes) and Hungary (23 700

tonnes). It is difficult to get a clear idea of Chinese exports for two reasons. First of all, interannual fluctuations in the volume of trade are great: Chinese exports to France in 1989 were 9 400 tonnes, but only 2 500 in 1991. This is partly because of true produc-

tion fluctuations in China, e.g. resulting from the VHD epidemic, and partly because of storage potential and carryover, as Chinese rabbit meat is almost exclusively sold frozen. The second reason is that China sometimes exports directly to developing countries, making it very difficult to gather data.

In Hungary, all output is aimed at the export market: less than 5 percent is for domestic consumption. Hungary is an exception here: only Croatia is near with 50 percent of the national output exported.

The main buyers in order of importance are Italy, Belgium, France and a few other Western European countries: the United Kingdom, Germany, the Netherlands and Switzerland. Other Eastern European countries also supply the above: the Czech Republic and Slovakia with 3 000 tonnes, Poland with 6 000 tonnes, Romania with 1 000 tonnes, and the former Yugoslavian countries of Croatia and Serbia.

The biggest importer in absolute terms is Italy, also apparently the prime consumer. The major Italian suppliers are Hungary, China, former Yugoslavia and sometimes Romania and Poland. Belgium is second, but with very strong export flows. France is the third importer in terms of quantity, importing from 4 000 to 12 000 tonnes depending on the year, mainly from the same suppliers as Italy, but with China in first place.

Imports for national consumption are largest in Switzerland with about 60 percent, which is partially explained by the very strict legislation on the conditions for production, resulting from the influence of the "eco-lobby". France is Switzerland's main supplier, followed by Hungary and China.

Some countries such as Belgium and France are both importers and exporters, with export prices generally topping import costs. France thus buys rabbits cheaply from China and sells rabbits at a much higher price to Switzerland. Likewise, Belgium, the Netherlands and even the United

Kingdom import from China and the Eastern European countries, while exporting part of their own output to France. In a similar vein, the United States imports from China and exports to Canada. China exports all rabbit meat in frozen form, whereas the Eastern European countries export mainly fresh meat. Some live rabbits are also exported from the Netherlands to France or from the former Yugoslavian countries of Slovenia and Croatia to Italy.

#### **The market for rabbit skins**

Data on skin marketing are much scantier than for rabbit meat. France appears to be the main producer of raw skins, but the practice of reimportation after partial treatment rather complicates the figures. France uses 56 percent of the skins it produces, about 70 million.

About 60 percent of these are poor-quality skins from which only the hair is recovered (12 to 20 percent of dry pelt weight). The best-quality skins are used after tanning for garments (5 to 8 percent) and linings, gloves and so on.

Most other producers also market rabbit skins but the CIS and Poland, for example, apparently make domestic use of all the skins they produce. Australia must be considered a producer, as it exports the skins of wild rabbits killed in extermination campaigns (small skins).

The main importers of raw skins are developing countries such as the Republic of Korea and the Philippines, with the low-cost labour to do the dressing. After fairly complete processing, these skins are re-exported to developed countries such as the United States, Japan, Germany and Italy.

#### **Angora wool**

Used mainly in textiles, the wool of the Angora rabbit forms a special sector of the international wool trade. World production is modest but the value per unit of weight is high: 40 to 50 times that of greasy wool.

Europe's share of the ever-growing world output, now estimated at 8 000 to 10 000 tonnes, is at present about 250 to 300 tonnes a year. Production is mainly concentrated in the Czech Republic and Slovakia (80 to 120 tonnes a year), France (100 tonnes), Hungary (50 to 80 tonnes) and, to a lesser extent, Germany (30 to 40 tonnes). But tonnages have again fallen in recent years as a result of marketing problems. A small amount is also produced in the United Kingdom, Spain, Switzerland, Poland and Belgium. Elsewhere in the world, Chinese production is by far the highest in the world at 8 000 to 9 000 tonnes a year. Japan also has a small output of 50 to 60 tonnes. Small quantities are also produced in Argentina, the Democratic People's Republic of Korea, the Republic of Korea and India.

There is brisk trading in both raw angora wool and the spun yarn. The main end-users are Japan, the United States, Germany and, particularly, Italy. The trade is characterized by regular four-year cycles due not to production, which is in fact regular, but to fluctuations in demand dictated by fashion. Since

1985, however, world prices have remained at rock-bottom levels.

### RABBIT MEAT QUALITY

#### Carcass composition

Carcasses are presented in different ways in different countries. Traditionally in certain African countries rabbits for the market are simply bled and gutted (only abdominal white offals). This was also true of Italy only a few years ago.

In France until recently the carcasses were sold skinned, with the thoracic viscera, liver and kidneys, and the head and paws still covered with fur. This changed in 1980 and now the paws must be removed.

In Canada and the United Kingdom the carcasses are dressed much as beef carcasses: no head, no viscera and, of course, no paws. So slaughter yields can vary greatly from one country to another. Yields also vary among breeds (Table 6) and according to age (Table 7) and diet (Tables 8 and 9). Slaughter yield improves with age: for a given carcass weight, animals with a high growth rate, receiving more balanced feed, generally have

TABLE 6  
Slaughter yields of different rabbit breeds and crosses  
at 10 to 12 weeks, in Belgium

Breeds and crosses	Live weight (kg)	Carcass yield		Proportion of rump (legs, back) to front portion	Dissectable fat (g)	Edible offals (liver, heart, kidneys) (g)
		Old French presentation (%)	Ready to cook (%)			
Blanc de Termonde (BT)	2.29	65.0	57.7	1.51/1	75	95
New Zealand White (NZ)	2.49	64.6	57.2	1.54/1	47	87
Californian (Calif.)	2.13	65.6	58.4	1.54/1	55	73
Bleu de Beveren (BB)	2.05	61.1	54.7	1.50/1	55	95
BT x NZ	2.33	62.7	55.9	1.62/1	90	87
BT x hybrid	2.26	63.2	55.7	1.56/1	43	95
Commercial hybrid	2.81	66.0	59.4	1.56/1	85	110
Calif. x BB	2.14	62.8	56.1	1.52/1	100	100

Source: Reyntens *et al.*, 1970.

TABLE 7  
Slaughter yield of New Zealand Whites, by age<sup>1</sup>

	Age in weeks			
	9	11	13	15
Live weight at slaughter <sup>2</sup> (kg)	1.70	2.12	2.47	2.67
Carcass weight (kg)	1.18	1.48	1.76	1.93
Slaughter yield (%)	69.2	69.8	71.6	72.1

<sup>1</sup> Italian presentation with skin.

<sup>2</sup> After 24-hour fast.

Source: Di Lella and Zicarelli, 1969.

TABLE 8  
Effect of feed type on slaughter yield: role of supplementary bulk feed

	Low-bulk feed		High-bulk feed	
	alone	+ straw	alone	+ straw
Straw content (%)		0		20
Crude fibre content (%)		4		12
Percentage of straw in free choice (% DM)	–	15.9	–	6.1
Live weight at 70 days (kg)	1.52	1.72	1.96	1.88
Carcass weight (kg)	0.94	1.0	1.20	1.14
Slaughter yield (%)	61.4	57.7	61.3	60.6

Source: Reyne and Salcedo-Miliani, 1981.

TABLE 9  
Impact of balanced feed on slaughter yield of Fauve de Bourgogne rabbits<sup>1</sup>

	Balanced feed	Alfalfa + maize <sup>2</sup>	Dehydrated alfalfa only
Age at 2.2 kg (days)	78	88	96
Conversion rate (DM)	3.92	4.80	6.90
Slaughter yield (%)	63.7	59.7	56.8
Fattening cost for 1 kg carcass (index)	100	89.8	123.9

<sup>1</sup> Average live weight at slaughter 2.2 kg.

<sup>2</sup> The ratio chosen by the animals was 36 percent maize and 64 percent dehydrated alfalfa.

Source: Lebas, 1969.

a better carcass yield. Too much roughage in the diet tends to overdevelop the digestive tract and thereby lower yield. A fibre-rich feed that did not lower the speed of growth would not modify slaughter yield, however.

#### Meat composition

Compared with the meat of other species, rabbit meat is richer in proteins and certain vitamins and minerals. However, it has less fat, as shown in Table 10.

TABLE 10  
Meat composition of different animal species  
Values given per 100 g of meat

	Energy (kcal)	Water (g)	Crude pro- teins (g)	Crude fats (g)	Crude ash (g)	Cal- cium (mg)	Phos- phorus (mg)	Potas- sium (mg)	So- dium (mg)	Iron (mg)	Vitamins					
											A (UI)	B <sub>1</sub> (mg)	B <sub>2</sub> (mg)	B <sub>5</sub> (mg)	Nico- tinic acid (mg)	Cal- cium panto- thenate (mg)
<b>Beef</b>																
Lean meat	195	66.5	20	12	1	12	195	350	65	3	40	0.10	0.20	1.5	5	0.45
Fatty meat	380	49	15.5	35	0.7	8	140	350	65	2.5	90	0.05	0.15	1.5	4	0.45
<b>Mutton</b>																
Lean meat	210	66	18	14.5	1.4	10	165	350	75	1.5	40	0.15	0.20	0.3	5	0.55
Fatty meat	345	53	15	31	1	10	130	350	75	1	80	0.15	0.20	0.3	4.5	0.55
<b>Pork</b>																
Lean meat	260	61	17	21	0.8	10	195	350	70	2.5	traces	0.85	0.20	0.3	4.5	0.50
Fatty meat	330	54.5	15	29.5	0.6	9	170	350	70	2.2	traces	0.70	0.15	0.3	4	0.50
<b>Chicken</b>	200	67	19.5	12	1	10	240	300	70	1.5	200	0.05	0.10	0.45	8	0.90
<b>Rabbit</b>	160	70	21	8	1	20	350	300	40	1.5	-	0.10	0.05	0.45	13	0.80

Source: Adrian, Legrand and Frangne, 1981.

TABLE 11  
Proportion of the principal fatty acids in fat deposits of different animal species

Fatty acids	C14:0	C16:0	C16:1	C18:0	C18:1	C18:2	C18:3
Tallow (ruminants)	4	27	2	24	42	2.5	-
Fat (pigs)	1	27	3	12.5	45	8	0.5
Fat (poultry)	0.1	26	7	7	40	20	-
Fat (rabbits)	3.1	29	6	6.1	28	17.9	6.5

Source: Adrian, Legrand and Frangne, 1981; Ouhayoun *et al.*, 1981.

Rabbit fat contains less stearic and oleic acids than other species and higher proportions of the essential polyunsaturated linolenic and linoleic fatty acids (Table 11).

The anatomical composition of the rabbit carcass varies with age. The proportion of

muscle mass to body weight remains constant: over 2 kg live weight for a strain weighing 4 kg (adult animal). But the proportion of fatty tissue tends to increase. This ratio shows up in meat composition, as Table 12 shows.

TABLE 12  
Changes in hindleg muscle tissue composition in New Zealand Whites, according to age

	Age		
	30 days	70 days	182 days
Degree of maturity (% of adult weight)	17	55	100
Water	77.7	74.9	72.7
Proteins (N x 6.25)	18.2	20.2	21.3
Fats	2.8	3.7	4.8
Mineral salts	1.2	1.2	1.2

Source: Ouhayoun, 1974.

TABLE 13  
Water losses from grilling rabbit meat, according to age and fat content

	Age of rabbits		
	86 days	96 days	105 days
Carcass weight (kg)	1.40	1.54	1.63
Kidney fat (% carcass)	1.5	2.2	3.4
Loss from cooking hindleg (%)	30.9	27.6	27.3
Loss from cooking back (%)	34.1	30.9	30.8
Fat content			
Leg (%)	4.8	4.9	6.0
Back (%)	1.5	1.7	1.6

Source: Fischer and Rudolph, 1979.

The proportion of oleic acid in the fat also increases with age and palmitic acid decreases.

#### Organoleptic properties

The organoleptic properties of rabbit meat, like those of other species, are tenderness, juiciness and flavour. Rabbit meat does not have a very strong flavour. It is comparable to, but not identical to, chicken.

Tenderness varies with muscle age and depends on changes in the proportion and type of conjunctive tissue supporting the muscle fibres. The younger the rabbits are slaughtered, the more tender the meat will be. On the other hand, flavour tends to develop with age. Although little research

has been done on this, it is known that flavour improves with the quantity of internal fat in the muscle. In the same way, juiciness depends largely on the fat content of the carcass. The fatter the carcass the lower its water content, but the better it retains what juice it does have (Table 13).

Slaughter conditions, especially the onset of rigor mortis, can modify the tenderness and juiciness of rabbit carcasses.

Selection for growth rate combined with confined rearing favour the anaerobic metabolism of rabbit muscle tissue. Animals raised in rational rabbitries therefore have a higher portion of white muscle fibre, which gives the meat a lighter colour.



### Customer appeal

In Latin countries, which are traditional rabbit consumers, customer appeal is no problem. Rabbit meat is even classified as "sought after" and is eaten on special occasions. However, it is less frequently served when a guest is invited to join the family at table. In Anglo-Saxon countries, rabbit meat is not a traditional food. It is thought of as wartime fare, conjuring up memories of food shortages. A century ago, however, tens of thousands of rabbits were imported every week from the Netherlands for the London market.

In other countries the situation varies greatly. Although the Koran in no way prohibits rabbit meat, production and consumption are virtually nil in most Arab countries. Yet rabbits are a traditional food in certain Maghreb countries such as Egypt and the Sudan.

In Mexico, people were not in the habit of eating rabbit meat until an advertising campaign boosted consumption. A reverse example is offered by Greece. A rational development programme of large-scale commercial production was implemented in mainland Greece in the late 1960s with relative success in technical terms. But marketing made no real headway as Greeks were not in the habit of eating this meat. There had been no advertising campaign to promote it so consumers did not buy it. Paradoxically, on the island of Crete, consumption is 10 kg per person per year.

The only religious bans concern the Hebrew religion (consumption in Israel outside the Arab population is nil) and certain Hindu sects (general ban on eating meat). Formerly, there was also a religious ban in force in Japan which forbade the eating of meat from four-legged animals. When rabbits were introduced into Japan in about 1350 by a Dutchman, the meat was sold as chicken. In modern Japan rabbit meat is eaten, although the total amount is still modest (1 000 tonnes from domestic pro-

duction plus 3 000 tonnes imported from China).

In the 1981 INRA-FAO survey of 64 developing countries reporting on the development potential for rabbit production in their countries, 70 percent thought it feasible and 22 percent considered that social customs would not favour it. The remaining 8 percent were against it for religious or other reasons.

Rabbit meat consumption is much easier to develop where people are already used to eating widely different kinds of meat, as from hunting. This would be generally true of sub-Saharan Africa. People with monotonous diets will find it harder to accept this new product. However, the example of Mexico, with its traditional diet of maize and kidney beans, shows that a well-planned development campaign can do much to promote the necessary change in eating habits.



## Chapter 2

# Nutrition and feeding

### ANATOMY AND PHYSIOLOGY

In an adult (4 to 4.5 kg) or semi-adult (2.5 to 3 kg) rabbit the total length of the alimentary canal is 4.5 to 5 m. After a short oesophagus there is a simple stomach which stores about 90 to 100 g of a rather pasty mixture of feedstuffs.

The adjoining small intestine is about 3 m long and 0.8 to 1 cm in diameter. The contents are liquid, especially in the upper part. Normally there are small tracts, about 10 cm long, which are empty. The small intestine ends at the base of the caecum. This second storage area is about 40 to 45 cm long with an average diameter of 3 or 4 cm. It contains 100 to 120 g of a uniform pasty mix with a dry matter content of about 22 percent. The caecal appendix (of 10 to 12 cm) has a much smaller diameter at the end. Its walls are composed of lymph tissues.

Very near the end of the small intestine, at the entrance to the caecum, begins the exit to the colon. The caecum thus appears to be a blind pouch branching off from the small intestine-colon axis (Figure 2). Physiological studies show that this blind pouch-reservoir forms part of the digestive tract: the contents circulate from the base to the tip passing through the centre of the caecum, then return towards the base, along the wall. The caecum is followed by a 1.5 m colon: this is creased and dented for about 50 cm (proximal colon) and smooth in the terminal section (distal colon).

These various organs are shown in Figure 2, which also presents data on the size and features of their contents.

The alimentary canal, which develops rapidly in the young rabbit, is nearly full

size in an animal of 2.5 kg, when it has reached only 60 to 70 percent of adult weight.

Two major glands secrete into the small intestine: the liver and the pancreas. Bile from the liver contains bile salts and many organic substances which aid digestion, but has no enzymes. The reverse is true of pancreatic juice which contains a sizeable quantity of digestive enzymes allowing the breakdown of proteins (trypsin, chymotrypsin), starch (amylase) and fats (lipase).

Generally speaking, the length of the small intestine (3 to 3.5 m) and its relatively small capacity contrast with that of the storage area (the stomach and caecum), which hold 70 to 80 percent of the total dry matter content of the digestive tract. The water content can vary markedly from one segment to the next owing to bodily secretions and water absorption.

### Digestive tract and caecotrophy

Feed eaten by the rabbit quickly reaches the stomach. There it finds an acid environment. It remains in the stomach for a few hours (three to six), undergoing little chemical change. The contents of the stomach are gradually "injected" into the small intestine in short bursts, by strong stomach contractions. As the contents enter the small intestine they are diluted by the flow of bile, the first intestinal secretions and finally the pancreatic juice.

After enzymatic action from these last two secretions the elements that can easily be broken down are freed and pass through the intestinal wall to be carried by the blood to the cells. The particles that are not broken down after a total stay of about one and

FIGURE 2

The digestive system of the rabbit

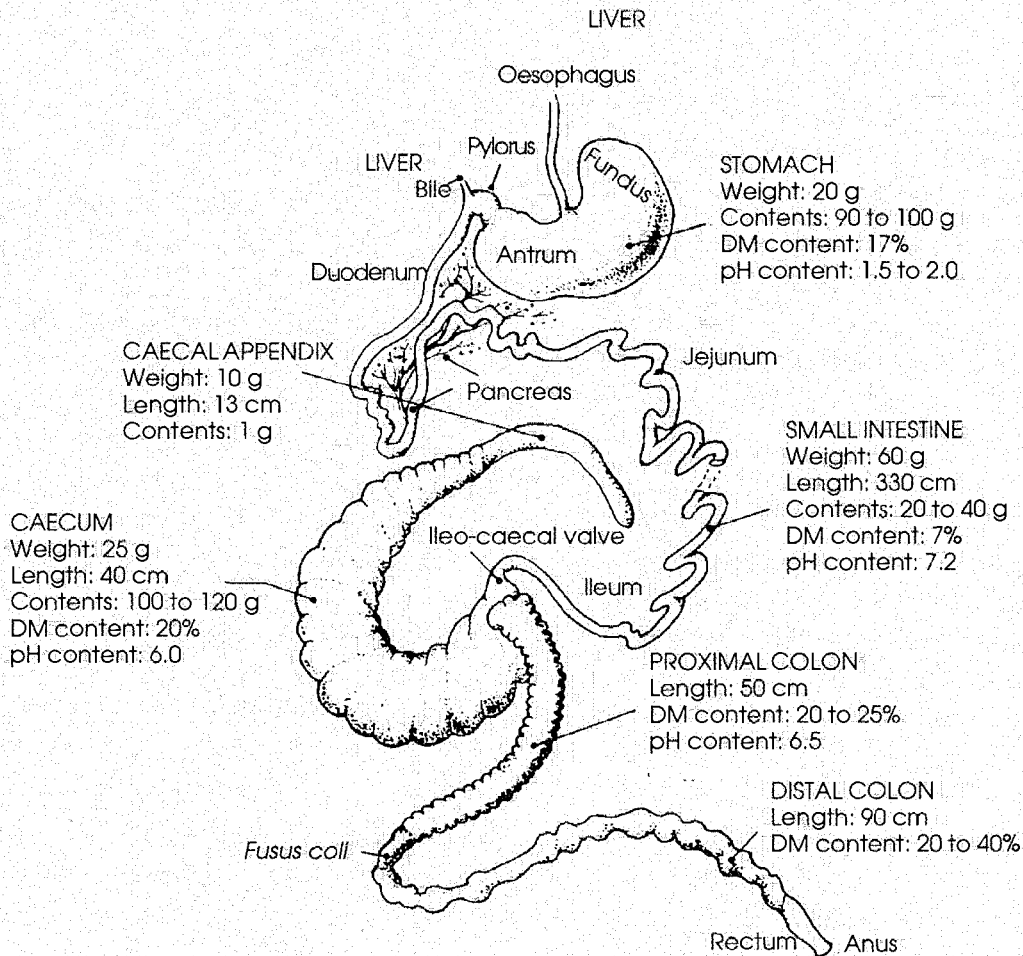

Note: Numerical values are those observed in the New Zealand White breed, aged 12 weeks, fed a complete balanced pelleted feed.

a half hours in the small intestine enter the caecum. There they have to stay for a certain time, from two to 12 hours, while they are attacked by bacterial enzymes. Elements which can be broken down by this new attack (mainly volatile fatty acids) are freed and in turn pass through the wall of the digestive tract and into the bloodstream.

The contents of the caecum are then evacuated into the colon. Approximately half consists of both large and small food particles not already broken down, while the other half consists of bacteria that have developed in the caecum, fed on matter from the small intestine.

So far, the functioning of the rabbit's digestive tract is virtually the same as that

of other monogastric animals. Its uniqueness lies in the dual function of the proximal colon. If the caecum contents enter the colon in the early part of the morning they undergo few biochemical changes. The colon wall secretes a mucus which gradually envelops the pellets formed by the wall contractions. These pellets gather in elongated clusters and are called soft or night pellets (more scientifically, caecotrophes). If the caecal contents enter the colon at another time of day the reaction of the proximal colon is entirely different.

Successive waves of contractions in alternating directions begin to act; the first to evacuate the contents normally and the second to push them back into the caecum.

Under the varying pressure and rhythm of these contractions the contents are squeezed like a sponge. Most of the liquid part, containing soluble products and small particles of less than 0.1 mm, is forced back into the caecum. The solid part, containing mainly large particles over 0.3 mm long, forms hard pellets which are then expelled. In fact, as a result of this dual action, the colon produces two types of excrement: hard and soft. Table 14 shows the chemical composition of these pellets.

The hard pellets are expelled, but the soft pellets are recovered by the rabbit directly upon being expelled from the anus. To do this the rabbit twists itself round, sucks in the soft faeces as they emerge from the anus, then swallows without chewing them. The rabbit can retrieve the soft pellets easily, even from a mesh floor. By the end of the morning there are large numbers of these pellets inside the stomach, where they may comprise three quarters of the total contents.

From then on the soft pellets follow the same digestive process as normal feed. Considering the fact that some parts of the intake may be recycled once, twice and even three or four times, and depending on the type of feed, the rabbit's digestive process lasts from 18 to 30 hours in all, averaging 20 hours.

The soft pellets consist half of imperfectly broken-down food residues and what is left of the gastric secretions and half of bacteria. The latter contain an appreciable amount of high-value proteins and water-soluble vitamins. The practice of caecotrophy therefore has a certain nutritional value.

The composition of the soft pellets and the quantity expelled daily are relatively independent of the type of feed ingested, since the bacteria remain constant. In particular, the amount of dry matter recycled daily through caecotrophy is independent of the fibre content of the feed (Table 15). The higher the crude content of the feed

and/or the coarser the particles, the sooner it passes through the digestive tract.

On the other hand, this particular function requires roughage. If the feed contains few large particles and/or it is highly digestible, most of the caecal contents are pushed back to the caecum and lose elements which nourish the "normal" bacteria living in the caecum. This would appear to increase the risk of undesirable bacteria developing in this impoverished environment, some of which might be harmful.

It is thus advisable to include a minimum of roughage in the feed, enabling the rabbit's digestive process to be completed fairly rapidly. In theory, roughage is provided by the crude-fibre content of the feed, as this is normally rather hard to digest. However, certain fibre sources (beetroot pulp, fruit pulp in general) are highly digestible (digestibility of crude fibre varies from 60 to 80 percent). Recommendations now made on quantities of indigestible crude fibre to be fed are therefore given below. Table 16 gives the chemical composition of various raw materials which can be fed to rabbits.

Caecotrophy regulation depends on the integrity of the digestive flora and is governed by intake rate. Experiments have shown that caecotrophy starts eight to 12 hours after the feeding of rationed animals, or after the intake peak of animals fed ad lib. In the latter case, the intake rate and hence the function of caecotrophy are governed by the light regime to which the animals are subjected.

Caecotrophy also depends on internal regulatory processes as yet not understood. In particular, the removal of the adrenals halts caecotrophy. Cortisone injections of animals without adrenals causes the resumption of normal behaviour. The digestive process of the rabbit appears to be highly dependent on adrenalin secretions. Hypersecretion associated with stress slows down digestive activity and entails a high risk of digestive ailments.

TABLE 14  
Composition of hard and soft faeces: averages and range for ten different feeds

Components	Hard pellets		Soft pellets	
	Average	Range	Average	Range
	(Percentage)			
Moisture	41.7	34-52	72.9	63-82
Dry matter	58.3	48-66	27.1	18-37
	(Percentage of dry matter)			
Proteins	13.1	9-25	29.5	21-37
Crude fibre	37.8	22-54	22.0	14-33
Fats	2.6	1.3-5.3	2.4	1.0-4.6
Minerals	8.9	3.1-14.4	10.8	6.4-10.8
Nitrogen-free extract	37.7	28-49	35.1	29-43

Note: Balanced concentrate feeds, green and dry forages.

Source: Proto, 1980.

TABLE 15  
Intake and excretion of dry matter by growing rabbits eating isonitrogenous feeds containing two levels of straw in place of maize starch

	Experimental feeds	
	Low fibre content	High fibre content
Straw content (%)	5	20
Crude-fibre content (%)	10.8	16.8
Daily dry-matter intake (g)	60 ± 28	67 ± 28
Dry matter excreted each day in:		
hard pellets (g)	20 ± 5	33 ± 8
soft pellets (g)	10 ± 4	10 ± 5

Note: Average ± 1 standard deviation from the mean.

Source: C. Dehalle, personal communication, 1979.

Caecotrophy first starts to function in young rabbits (domesticated or wild) at the age of about three weeks, when they start eating solid feed in addition to mother's milk.

#### FEEDING BEHAVIOUR

Feeding behaviour studies have basically involved rabbits receiving balanced concentrates or fed ad lib on dry feed (cereals, straw, dry forage).

The feeding pattern of newborn rabbits is imposed by the dam. A doe feeds her young only once every 24 hours (although some does will nurse their young twice). Suckling lasts only two or three minutes. If there is not enough milk the young try to feed every time the doe enters the nestbox, but she will hold back her milk. This behaviour signals insufficient milk production in the doe.

TABLE 16  
Chemical composition of different raw materials suitable for feeding rabbits

	DM	F	CF	ICF	TN	Lys	SAA	Mx	Ca	P	DE
Oats	86	5.3	10.2	9.8	10.0	0.40	0.50	2.70	0.08	0.34	2 800
Wheat	86	1.9	2.3	1.0	11.3	0.32	0.47	1.65	0.06	0.33	3 100
Maize	86	4.2	2.2	0.6	9.0	0.25	0.39	1.35	0.01	0.27	3 200
Barley	86	2.0	4.0	3.8	10.0	0.37	0.42	2.30	0.05	0.35	3 000
Sorghum	86	3.0	2.5	1.0	10.0	0.23	0.33	1.45	0.03	0.30	3 150
Paddy rice	87	2.1	8.6	6.5	8.0	0.28	0.35	4.53	0.05	0.26	2 850
Fine wheat bran	87	4.0	9.6	6.8	15.0	0.56	0.50	5.60	0.13	1.20	2 300
Second-quality wheat flour	88	2.7	1.4	0.1	14.9	0.50	0.46	2.00	0.07	0.45	3 200
Brewery draff	91	7.6	15.3	3.5	25.2	0.70	0.61	4.07	0.28	0.50	2 800
Maize bran	89	6.3	9.0	3.8	10.1	0.27	0.36	2.69	0.03	0.23	2 750
Soya cake 44	88	1.8	7.4	6.8	42.5	2.70	1.27	6.00	0.30	0.62	3 260
Soya cake 48	88	2.0	5.6	4.8	45.8	2.91	1.37	6.30	0.30	0.69	3 310
Sunflower cake	90	1.8	26.5	18.6	29.5	1.07	1.26	6.22	0.35	0.90	2 770
Rapeseed cake	89	1.8	11.7	7.4	35.2	1.93	1.73	7.00	0.75	1.10	2 800
Cottonseed cake	91	1.4	13.0	9.0	41.0	1.72	0.59	6.46	0.20	1.00	2 790
Horse bean	87	1.3	7.5	5.0	26.4	1.66	0.53	3.38	0.11	0.61	2 800
Field pea	86	1.6	5.5	4.0	22.0	1.60	0.59	3.40	0.08	0.45	2 800
Extruded soya	89	18.0	6.0	4.2	37.0	2.35	1.15	4.45	0.25	0.57	4 400
Grass meal	91	3.7	21.0	14.3	17.1	0.75	0.44	12.7	0.70	0.42	1 730
Dehydrated alfalfa A	90	3.0	27.0	22.0	15.5	0.68	0.42	9.00	1.40	0.25	1 800
Dehydrated alfalfa B	90	2.9	25.0	20.5	16.6	0.73	0.45	9.45	1.50	0.25	1 850
Soybean husks	92	2.0	34.0	32.0	12.7	0.70	0.35	5.69	0.40	0.17	1 800
Cocoa husks	90	4.5	18.6	14.0	16.5	0.90	0.38	7.62	0.30	0.35	2 190
Wheat straw	88	1.3	42.0	39.0	4.0	0.20	0.12	8.30	0.47	0.09	700
Sugar-beet pulp	90	1.0	18.0	5.0	8.8	0.54	0.13	5.42	0.90	0.11	2 700
Citrus pulp	90	3.0	12.0	5.1	6.0	0.25	0.06	5.45	2.10	0.12	3 000
Gluten feed	90	3.0	8.3	4.6	21.0	0.69	0.97	7.10	0.28	0.70	2 770
Cassava	85	0.17	4.6	2.0	2.6	0.09	0.06	5.22	0.30	0.19	2 850
Carob bean	86	2.4	7.8	7.0	5.0	0.18	0.16	3.43	0.65	0.10	2 390
Sugar-beet molasses	77	0.3	0.0	0.0	7.7	0.04	0.10	8.93	0.25	0.02	2 600
Animal fat	99.5	99.5	0.0	0.0	0.0	0.0	0.0	0.0	0.0	0.0	8 000
Soybean oil	99.5	99.5	0.0	0.0	0.0	0.0	0.0	0.0	0.0	0.0	8 500
Meatmeal A	92	7.5	0.0	0.0	59.0	3.46	1.39	22.7	7.05	3.35	3 180
Meatmeal B	95	14.5	0.0	0.0	58.2	3.40	1.34	19.3	6.55	3.10	3 680
Fishmeal	91	8.3	0.0	0.0	67.8	5.00	2.50	15.0	3.90	2.55	4 160

Note: Dry matter (DM); fat (F); crude fibre (CF), indigestible crude fibre (ICF); total nitrogen (TN); Lysine (Lys); Sulphurous amino acids (SAA); total minerals (Mx); Calcium (Ca) and phosphorus (P) as percentage of feed. Digestible energy (DE) in kcal/kg of feed.

Sources: INRA, 1989; Maertens *et al.*, 1990.

From the third week of life the young rabbits begin to move about, taking a few grams of mother's milk and a little drinking water if available. In a few days the intake of solid feed and water will exceed the milk intake. During this period the changes in feeding behaviour are remarkable: the young rabbit goes from a single milk feed a day to a large number of alternating solid and liquid feeds distributed irregularly throughout the day: 25 to 30 solid or liquid meals every 24 hours.

Table 17 gives an example of changing feeding behaviour in New Zealand White rabbits, aged from six to 18 weeks.

The number of solid meals, stable up to 12 weeks, tends to decrease slightly thereafter. The total feeding time in a 24-hour period exceeds three hours at age six weeks. It then drops off rapidly, to less than two hours. At any age, feed containing over 70 percent water, such as green forage, will provide rabbits with ample water at temperatures below 20°C.

The consumption of solid and liquid intake fluctuates over a 24-hour period, as shown in Figure 3. Much more liquid and solid feed is consumed in the dark than in the light.

Intake in experimental hutches is very high just before the lights are switched off. As the rabbit grows older the nocturnal nature of its feeding habits becomes more pronounced. The number of feeds during light periods drops and the morning "feeding rest" tends to lengthen. The feeding habits of wild rabbits are even more nocturnal than those of domesticated rabbits.

The intake of feed and water depends on the kind of feed and also on the type of rabbit and its age and stage of production. Taking as a reference animal an adult fed ad lib (140 to 150 g of dry matter per day, for example, for a 4 kg New Zealand White): at four weeks a young rabbit eats a quarter of the amount an adult eats but its live weight is only 14 percent of the adult's. At eight weeks the relative proportions are 62 and 42 percent; at 16 weeks they are 100 to 110 and 87 percent.

A doe's ad lib feeding during the reproduction cycle varies greatly (see Figure 4). The intake during the final days of pregnancy drops off markedly. Some does refuse solid food just before kindling. Water intake, however, never stops completely. After kindling, the feed intake increases very rapidly and can exceed 100 g dry

TABLE 17  
Changing feed habits of nine New Zealand White male rabbits aged from 6 to 18 weeks, given water and balanced feed ad lib in a room kept at 20±1°C

	Age in weeks		
	6	12	18
<b>Solid feeds (89% DM)</b>			
Total quantity (g/day)	98	194	160
No. of meals per day	39	40	34
Average quantity per meal (g)	2.6	4.9	4.9
<b>Drinking water</b>			
Total quantity (g/day)	153	320	297
No. of drinks per day	31	28.5	36
Average weight of one drink (g)	5.1	11.5	9.1
Water/feed ratio (DM)	1.75	1.85	2.09
Water content calculated for whole of solid feed and drink intake	65.3	66.4	68.8

Source: Prud'hon, 1975.



FIGURE 3

Hourly distribution of daily intake of water and balanced pelleted feed of a 12-week-old rabbit over a period of 24 hours

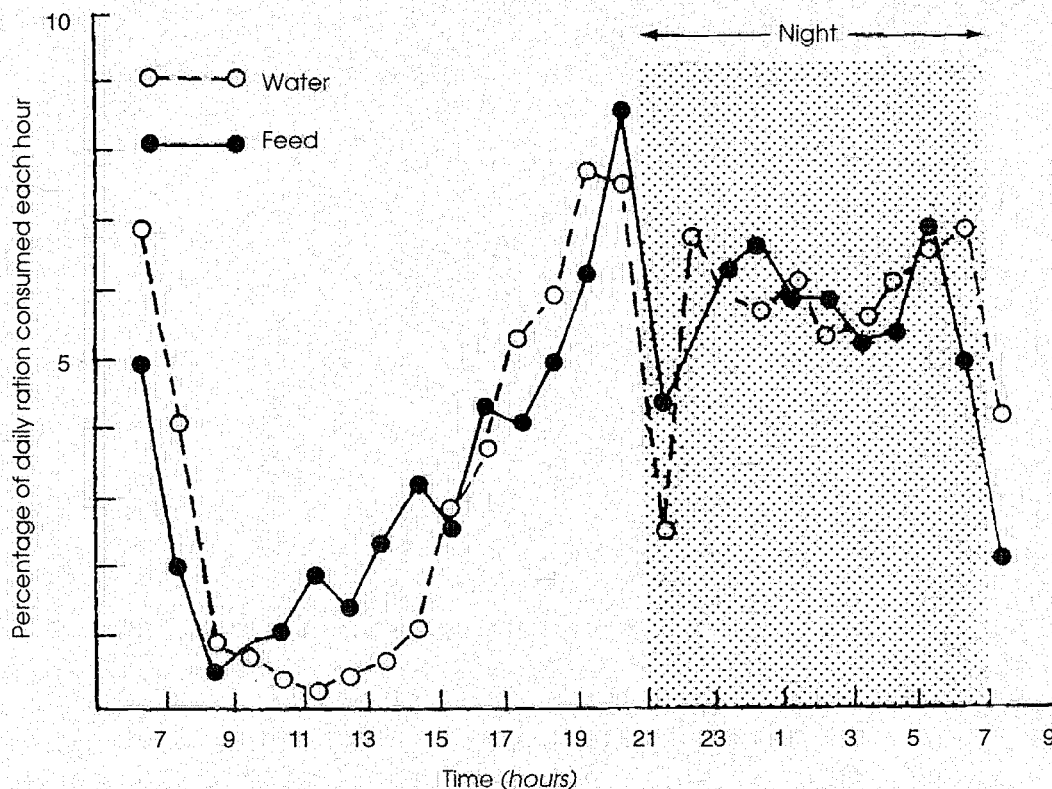

Source: Prud'hon, 1975.

matter/kg live weight a day. Water intake is also high at that time: from 200 to 250 g a day per kg of live weight. A doe that is both pregnant and lactating will eat the same amount as a doe that is lactating only.

#### Feeding and environment

The rabbit's energy expenditure depends on ambient temperature. Feed intake to cope with energy needs is therefore linked to temperature.

Laboratory tests on growing rabbits have shown that at temperatures between 5°C and 30°C intake of pelleted feed dropped from 180 to 120 g a day and water intake rose from 330 to 390 g (Table 18).

A closer analysis of feeding behaviour shows that as temperature rises the number of solid and liquid meals eaten in 24

hours drops. From 37 solid feeds at 10°C the number drops to only 27 at 30°C (young New Zealand White rabbits). The amount eaten at each meal drops with high temperatures (5.7 g from 10°C to 20°C down to 4.4 g at 30°C) but the water intake goes up, from 11.4 to 16.2 g between 10°C and 30°C.

A recent study by Finzi, Valentini and Fillipi Balestra (1992) shows a marked increase in the water/food intake rate at higher temperatures (20°C, 26°C and 32°C), which was already known, but the various ingestion and excretion ratios are also modified (Table 19). The authors propose that these ratios, the easiest to measure locally, be used to identify thermal stress in rabbits.

If drinking water is not provided and the only feed available is dry with a moisture content of less than 14 percent, dry matter

FIGURE 4

Changing intake of balanced concentrate feed (89 percent DM) in a doe during gestation and lactation

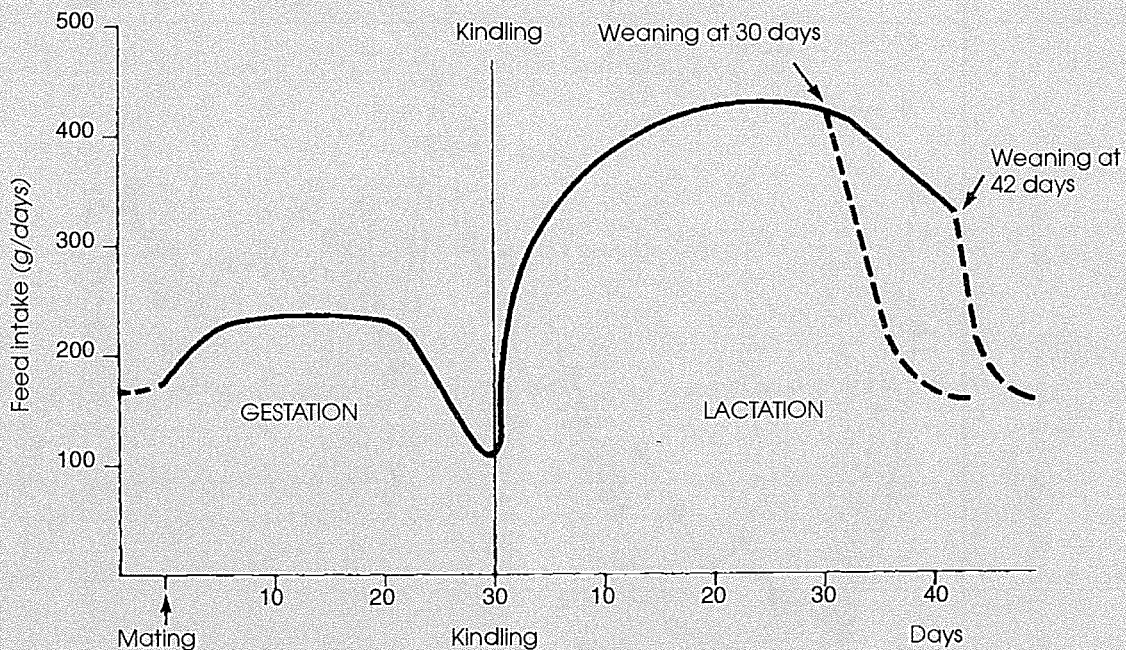

Source: Lebas, 1975.

intake drops to nil within 24 hours. With no water at all, depending on temperature and humidity, an adult rabbit can survive from four to eight days without any irreversible damage, although its weight may drop 20 to 30 percent in less than a week.

Rabbits with access to drinking water but no solid feed can survive for three or four weeks. Within a few days they will drink four to six times as much water as normal. Sodium chloride in the water (0.45 percent) reduces this high intake, but potassium chloride has no effect (sodium loss through urination). The rabbit is therefore very resistant to hunger and relatively resistant to thirst; but any reduction in the water supply, in terms of water requirements, causes a proportional reduction in dry matter intake, with a consequent drop in performance.

The growth performance of rabbits is

significantly reduced if they are given salted drinking water with a sodium content higher than 1 percent.

Work in Egypt by Ayyat, Habeeb and Bassuny (1991) showed a 12 to 16 percent slowing of growth speed at sodium contents of over 1.5 percent (Table 20). Solid granulated feed ingestion remained unchanged by water salinity whereas water intake increased slightly with salinity: 14 to 16 percent in the trial by Ayyat and colleagues. However, even at sodium contents exceeding 2 to 4 g (6 g of Rashid salt), no mortality was reported from this eight-week trial, and the rabbits still grew at a rate of 23 g/day: 77 percent compared with the control.

#### Feeding preferences

Given a choice of several feeds rabbits are often unpredictable. When dehydrated al-

TABLE 18  
Changing feed and water intakes of growing rabbits in changing temperatures

	5°C	18°C	30°C
Ambient temperature	5°C	18°C	30°C
Relative humidity	80	70	60
Pelleted feed eaten* (g/day)	182	158	123
Water drunk (g/day)	328	271	386
Water/feed ratio	1.80	1.71	3.14
Average weight gain (g/day)	35.1	37.4	25.4

\* Balanced pelleted feed containing 20 percent crude protein and 11 percent crude fibre, rich in protein and energy.  
Source: Eberhart, 1980.

TABLE 19  
Impact of ambient temperature on intake and excretion ratios in adult rabbits

Ratios	20°C	26°C		32°C	
	Average A	Average B	B/A (%)	Average C	C/A (%)
Water/feed	1.7	3.5	206	8.3	489
Urine/feed	1.0	1.6	167	4.0	413
Water/faeces	1.9	5.5	287	11.2	583
Urine/faeces	1.1	2.5	234	5.3	493

Source: Finzi, Valentini and Fillipi Balestra, 1992.

TABLE 20  
Impact of drinking-water salinity on rabbit growth performance

Salt added to water (g/litre)	0	1.5	3.0	4.5
Water content (ppm)				
Ca	11	99	187	275
Mg	11	21	31	41
K	8	143	278	413
Na	399	901	1 403	1 905
Cl	107	753	1 399	2 045
Bicarbonates	320	395	470	545
Total minerals	906	2 409	3 912	5 415
Live-weight gain (g/day)	29.7 ±1.4	28.9 ±0.9	24.3 ±1.0	22.6 ±1.1
Feed intake (g/day)	125	139	126	124

Source: Ayyat, Habeeb and Bassuny, 1991.

falfa and dry grain maize are offered the ratio chosen is 65 percent alfalfa to 35 percent maize. With alfalfa and oats the ratio is 60 to 40. But if the maize grains are rather

moist, say with a 14 to 15 percent moisture content which could cause storage problems, the proportion of maize rises to 45 to 50 percent. When rabbits are offered ra-

tions containing dehydrated alfalfa with a variable saponin content, which gives the feeds varying degrees of bitterness, they choose the relatively bitter feeds. Such feeds are ignored by rats and pigs, as shown by Cheeke, Kinzell and Pedersen's (1977) tests in the United States.

Feeding rabbits forage plus supplementary concentrate feed raises problems when the forage is not very palatable. The experimental findings in Table 21 demonstrate that in ad lib feeding of both high-bulk (straw, in this trial) and high-energy pelleted feeds rabbits are unable to adjust intake for maximum growth. A breeder faced by such a situation should limit the daily dose of concentrate feed or, generally speaking, the proportion of the more palatable feed. The problem sometimes arises with certain low-value green forages.

The situation changes if the rabbit is faced with two high-energy foods, as in Gidenne's (1986) trial with ad lib feeding of balanced pelleted feed and green banana. In this example, the ad lib trial rabbits grew as much as the control group and their digestible energy intake was identical. However, between weaning at five weeks and the close of the 12-week trial, the banana intake

dropped from 40 percent to 28 percent of the daily dry matter intake.

Growing rabbits receiving a pelleted feed lacking in sulphur amino acids or lysine, with access to pure water as well as those missing amino acids in solution, choose the amino acid solution over pure water. Thus they grow as well as control rabbits receiving balanced feed.

#### NUTRITIONAL NEEDS

Various research experiments carried out in many countries (especially France) in the last 20 years or so have resulted in reliable recommendations for the manufacture of rabbit feeds for meat and milk production in temperate European conditions.

The experimental technique consists of manufacturing feeds in exact but varied mixes, feeding them to rabbits and assessing production by weight gain or number and weight of young in a litter. The best feeds are thus established and the best mixes selected, allowing nutrition experts to draw up recommendations for several categories. The most common feed categories in intensive European rabbitries are for breeding females (lactating does, pregnant

TABLE 21

**Feed intake and growth of New Zealand White rabbits aged between five and nine weeks, receiving ad lib a concentrated feed rich or poor in fibre, with and without wheat-straw pellets 5 mm in diameter**

	Fibre-rich feed		Fibre-poor feed	
	Alone	+ straw	Alone	+ straw
<b>Feed composition (%)</b>				
Straw		20		0
Protein		16.1		15.6
Crude fibre		11.7		4.1
<b>Method of administration</b>				
<b>Intake (g/day)</b>				
Feed (F)	94.7	88.3	63.4	63.3
Wheat straw (S)	—	7.4	—	12.2
Total F and S	94.7	95.7	63.4	75.5
<b>Gain in live weight (g/day)</b>				
	31.7	31.0	22.4	26.6

Source: Reyne and Salcedo-Miliani, 1981.

or not), young rabbits of weaning age (post-weaning or peri-weaning feeds, the latter also consumed by the mother) and rabbits for fattening. Also included in the range supplied by livestock feed manufacturers is a mixed feed that can acceptably cover the nutritional needs of all rabbit categories providing the breeder's objective is not maximum productivity.

These standards have been established for environmental conditions in Europe and are also based on the relative costs of nutrients in European countries. They are reference standards, but can be varied slightly for better economic performance according to locally available cheap feed resources. The upper and lower limits (which should not be exceeded) are listed at the end of this chapter.

Lactating does need the richest, most concentrated feed. They produce a milk three times richer than cow's milk, at the rate of 100 to 300 g per day, and have few reserves in relation to the demand made on them. The next category is growing rabbits (far more research work has been done on this than any other category). Young rabbits are followed by pregnant non-lactating does. Their feed can be slightly less rich than that of young growing rabbits. The last category is bucks, which do not need a rich diet.

Table 22 details the chemical composition of theoretically ideal feeds for each rabbit category. There are four broad classes of standards. First, standards on proteins and protein composition (distribution of amino acids). Proteins must supply the elements to build or rebuild rabbit bodies. The proportion of indigestible fibre serves to provide the slight congestion essential for the proper functioning of the digestive tract. The corresponding proportion of fibre can also be estimated by the acid detergent fibre (ADF) content as per Van Soest or, preferably, indigestible ADF. Energy is needed to regulate body temperature as well as for the general functioning

of the body. Minerals and vitamins are building blocks for certain parts of the animal (skeleton, etc.) and for the enzymes which use energy to build and rebuild the body proteins continually. Table 22 also includes a column showing the chemical composition of a mixed feed suitable for all animals in a production unit. Its composition represents a compromise between the requirements of growing rabbits and those of lactating does. The other categories can, in fact, eat a richer feed without suffering any major drawbacks. Further on in the text it will be explained under what circumstances it is desirable to use mixed or more specialized feeds. But, first, the various feed requirements are explored in greater depth.

**Nitrogen.** The rabbit's response to the quality of the proteins in its diet, long a controversial issue, has now been established beyond doubt. Researchers have found that growing rabbits need feed that contains certain amounts of ten of the 21 amino acids that made up the proteins. These are called the basic or essential amino acids. With two additional amino acids which can partially replace two of the essential amino acids, this is the full list for rabbits: arginine, histidine, leucine, isoleucine, lysine, phenylalanine plus tyrosine, methionine plus cystine, threonine, tryptophane and valine.

Studies on the quantities needed have been virtually confined to arginine, lysine and the sulphur amino acids (methionine and cystine). Expressed as a percentage of the ration, the lysine requirements for growing rabbits are 0.6 and, for sulphur amino acids, 0.7 percent. The lysine intake of breeding does should be considerably higher under intensive milk production to feed nine to 12 young. The arginine intake should be at least 0.8 percent, and a little more for growing rabbits. The toxicity thresholds of lysine and arginine are well above the recommended intake levels. For the sulphur

TABLE 22  
Recommended chemical composition of feeds for intensively reared rabbits of  
different categories

Components of feed, assumed to contain 89 percent dry matter	Young rabbit (4 to 12 weeks)	Lactating doe	Peri- weaning	Mixed (maternity + fattening)
Crude proteins (%)	16	18	15	17
Digestible proteins (%)	11.5	13.3	10.8	12.4
<b>Amino acids</b>				
Methionine + cystine (%)	0.60	0.60	0.55	0.60
Lysine (%)	0.70	0.90	0.65	0.70
Arginine (%)	0.90	0.80	0.80	0.90
Threonine (%)	0.55	0.70	0.55	0.60
Tryptophane (%)	0.13	0.20	0.12	0.13
Histidine (5)	0.35	0.43	0.35	0.40
Isoleucine (%)	0.60	0.70	0.67	0.65
Phenylalanine + tyrosine (%)	1.20	1.40	1.10	1.25
Valine (%)	0.70	0.85	0.68	0.80
Leucine (%)	1.05	1.25	1.00	1.20
<b>Energy and bulk</b>				
Digestible energy (kcal/kg)	2 500	2 650	2 400	2 550
Metabolizable energy (kcal/kg)	2 380	2 520	2 280	2 420
Fats (%)	3-5	4-5	3	3-4
Crude fibre (%)				
Indigestible crude fibre (%)	12	10	14	12
ADF (%)	18	14	20	18
Ratio digestible proteins/digestible energy (g/1 000 kcal)	45	51	46	48
<b>Minerals</b>				
Calcium (%)	0.40	1.20	1.00	1.10
Phosphorus (%)	0.30	0.50	0.50	0.60
Potassium (%)	0.60	0.90	0.60	0.90
Sodium (%)	0.30	0.30	0.30	0.30
Chlorine (%)	0.30	0.30	0.30	0.30
Magnesium (%)	0.25	0.25	0.25	0.25
<b>Vitamins</b>				
Vitamin A (IU/kg)	6 000	10 000	10 000	10 000
Vitamin D (IU/kg)	1 000	1 000	1 000	1 000
Vitamin E (ppm)	50	50	50	50
Vitamin K (ppm)	0	2	2	2
Vitamin C (ppm)	0	0	0	0
Vitamin B <sub>1</sub> (ppm)	2	-	2	2
Vitamin B <sub>2</sub> (ppm)	6	-	6	4
Vitamin B <sub>6</sub> (ppm)	2	-	2	2
Vitamin B <sub>12</sub> (ppm)	0.01	0	0.01	0.01
Folic acid (ppm)	5	-	5	5
Pantothenic acid (ppm)	20	-	20	20
Niacin (ppm)	50	-	50	50
Biotin (ppm)	0.2	-	0.2	0.2

Source: Lebas, 1989.

amino acids, however, there is a slender margin between the amount the rabbit needs and an excess dose that would diminish its performance.

The recommended amounts of other essential amino acids have been estimated simply on the basis of regular satisfactory

diets. Where these essential amino acids are supplied by protein in the diet, 15 to 16 percent crude proteins should be enough for fattening rabbits. Rabbits will always eat more of a balanced feed containing essential amino acids than the same feed without amino acids.

Amino acid balance can easily be achieved with plant protein alone as in almost all balanced European feeds. Proteins of animal origin can be used by rabbits but are absolutely unnecessary: all that counts is the amino acid intake, not the substratum.

The optimum dose of crude protein for the breeding doe seems to be roughly 17 to 18 percent. An increase of protein content to 21 percent leads to higher milk production but slightly reduces the number of young rabbits weaned in a given period.

Lastly, various attempts to replace true proteins by non-protein nitrogen (urea and ammonium salts) have almost all been economic failures, because these sources of nitrogen either degrade or are absorbed too early for the micro-organisms in the caecum to take them up. For a highly nitrogen-deficient ration (30-50 percent below requirements), however, or for a non-protein source which breaks down at average speeds in the intestine (such as biuret), there is a certain amount of uptake. In any case, it is highly recommended that rabbits receive their nitrogen ration in the form of true proteins with balanced amino acids.

**Energy and crude fibre.** The energy needed for organic synthesizing is usually supplied by carbohydrates and to a lesser extent by fats. Where there is an excess of proteins these also help to supply energy after deamination.

The growing rabbit, like the breeding doe, adjusts its feed intake according to the energy concentration of the feeds offered to it where the proteins and other dietary components are balanced. For a growing New Zealand White or Californian rabbit the daily intake is around 220 to 240 kcal of digestible energy (DE) per kg of metabolic weight ( $W^{0.75}$ ). For the lactating doe the average amount is 300 kcal DE/kg  $W^{0.75}$  and tops 360 kcal during maximum milk production (15th to 20th day of lactation).

So it is hard to set a strict energy requirement, but it has been shown that intake is only correctly regulated between 2 200 and 3 200 kcal DE/kg of feed.

Because of this, concentrated energy feed must also contain all the other required nutrients in concentrated form so that a smaller volume of feed will supply the rabbit's needs.

Energy intake regulation functions well in temperate climates so long as variations in energy content are linked to the presence of fairly digestible carbohydrates (e.g. starch/fibre substitution). At high temperatures (28° to 32°C), however, and/or where more than 10 percent of the digestible energy is provided by fat, regulation may suffer and the animals may easily consume more of the fattier feed owing to the absence of extra heat from the consumption of lipids.

The rabbit is known to have a specific need for essential fatty acids (linoleic acid), but a conventional diet containing 3 to 4 percent fats generally supplies this. The only reason for including more fat in the diet would be to raise the energy concentration, as fats provide approximately twice as much energy as carbohydrates for the same weight. Depending on the kind of basic diet (basic energy level, protein content and quality), such an input of fats might or might not be nutritionally useful. The feed energy for breeding does or growing/fattening rabbits can be supplied in the form of starch. A young rabbit less than 40 days old, however, digests starch poorly as the digestive apparatus has not yet attained functional maturity. For this reason, post- and particularly peri-weaning feeds used for 20- to 40-day rabbits should not contain over 12 to 13 percent starch to avoid digestive problems.

In European feed rations, the poor digestibility of the fibrous parts of raw materials such as alfalfa and straw (digestibility 10 to 30 percent) makes them secondary to

starch, for example, in covering energy needs. However, the fibrous components from tender, usually young, plants are much more digestible (30 to 60 percent). They can then provide 10 to 30 percent of energy requirements in favourable conditions.

The fibrous parts have another function: as bulk. Content is generally evaluated on the basis of crude fibre, although this analytical technique is far from perfect. To get enough bulk for growing rabbits a 13 to 14 percent crude-fibre content seems satisfactory. For lactating does a slightly lower content is acceptable (10 to 11 percent). The more digestible the fibrous parts the higher the total input needed to supply at least 10 percent indigestible crude fibre.

**Minerals and vitamins.** Studies on the calcium and phosphorus requirements of growing rabbits have shown they need much less than lactating does. Does transfer large amounts of minerals into their milk: 7 to 8 g a day in full lactation, of which about one quarter is calcium.

Any sodium, potassium or chlorine imbalance in the diet can cause nephritis and birth accidents. The risk is particularly high when plants used in the feed have been fertilized with high rates of potassium.

Some authors mention improved growth performance with excess intake of copper sulphate: 200 ppm copper. As with pigs, this must be an effect of the growth-factor type.

Even so, the importance of copper sulphate as a growth factor is not universally conceded and some authors have noted negative consequences (higher mortality) with supplements of about 150 to 200 ppm.

Rabbits require water-soluble (B group and C) as well as fat-soluble vitamins (A, D, E, K). Micro-organisms in the digestive flora synthesize sizeable quantities of water-soluble vitamins which are utilized by the rabbit through caecotrophy. This

intake is sufficient to cover maintenance requirements and for average production as far as the B group vitamins and vitamin C are concerned. However, fast-growing animals respond favourably to the addition of 1 to 2 ppm of vitamins B<sub>1</sub> and B<sub>6</sub>, 6 ppm of vitamin B<sub>2</sub>, and 30 to 60 ppm of nicotinic acid (vitamin PP) in the diet. The addition of vitamin C will not influence growth, even at 1 percent of diet, for better or for worse, under temperate conditions.

For fat-soluble vitamins, research has focused more on deficit or excess than on the exact determination of requirements. The recommendations proposed thus comprise a certain safety margin. However, excessive intakes of Vitamin A (100 000 IU/kg of feed) or Vitamin D (3 000 IU/kg of feed) can entail serious disturbances, particularly in breeding females. It is therefore advisable not to feed megadoses of vitamins to rabbits.

#### **Deviating from standard recommendations**

Feeds formulated in accordance with the standards given in Table 22 are satisfactory for intensive production. Rabbits can also be reared on feeds only approximating these standards, but the absolute performance level will be lower, although not necessarily uneconomical. Certain indicative values are given in Table 23. Reducing the protein intake of lactating does to 12 to 13 percent of the diet will not affect prolificacy but will cause a regular reduction of milk production and a parallel drop in the weight of the young at weaning.

Additionally, it is better to consider the protein/energy ratio in relation to the intake of bulk fibre, rather than the protein rate in itself.

Some research indicates that rabbits need a certain minimum of fibre for regular digestion: 9 to 10 percent of indigestible crude fibre. Otherwise, there is increasing mortality from diarrhoea, although the low roughage/mortality association is not sys-



TABLE 23  
Decline in performance at levels of protein or selected essential amino acids in the feed below recommended values, and minimum acceptable levels

Reduction of proportion in ration	Decrease in weight gain		Increase in feed conversion rate		Minimum acceptable levels (%)
	Absolute value (g/day)	Percentage	Absolute value (g/day)	Percentage	
Proteins (1 point)	-3	-8.5	+0.1	+3	12
Methionine (0.1 point)	-2	-6	+0.1	+3	0.40
Lysine (0.1 point)	-5	-14	+0.1	+3	0.40
Arginine (0.1 point)	-1.5	-4.5	+0.1	+3	0.50

tematic and may affect experimental lots in random fashion.

A crude-fibre content of 13 to 14 percent appears sufficient for growing rabbits. It is not possible to establish a reliable relationship between the intake of fibrous parts and mortality in fattening rabbits at rates of 12 to 16 percent of crude fibre.

Finally, as indicated above, excessive fibre intake usually alters the digestible energy content of the feed below the intake regulation threshold.

If this is accompanied by a higher digestible protein/digestible energy ratio, rabbits will suffer energy deficit and protein surplus at the same time, favouring the excessive production of proteolytic digestive flora which produces ammonia and leads to increased digestive problems (Figure 5, curve A).

While an intake of more than 16 percent of fibrous parts is linked to a reduction in digestible proteins, entailing a static or reduced ratio of digestible protein to digestible energy, no harmful effect on the viability of fattening rabbits is observed (Figure 5, curve B). The only alteration is in growth performance due to the energy deficit.

Where a high intake of fibrous parts places the feed exactly at the minimum threshold for energy regulation (2 250 to 2 300 kcal

DE), and protein intake is excessive, there is a very high risk of blockage from constipation in growing rabbits. Similarly, mineral bulk can reduce energy concentration.

As for minerals, where calcium and phosphorus in the diet are insufficient, lactating does draw on their bodily reserves, principally those stored in the bones, but the total store is small compared with the amount exported. Under these conditions, intensive production of does is not feasible. As an indication, the minimum and maximum thresholds are given in Table 24 for various minerals, some vitamins and essential amino acids. It should be stressed that the optimum feed rate for some animals is close to the maximum tolerable rate. This is true of vitamin D and phosphorus in breeding does and for sulphur amino acids in growing rabbits. Where too much is supplied performance may drop, to the breeder's surprise, and the risk is particularly high if he or she uses supplements that are added to the feed or drinking-water. Toxicity symptoms can closely resemble the symptoms of deficit, as is true of vitamin A.

In the case of multiple deficiencies, it is difficult to predict the animals' reaction. Direct experiment for on-site measurement of the actual consequences of the proposed

FIGURE 5  
Role of fibre intake in the health of fattening rabbits

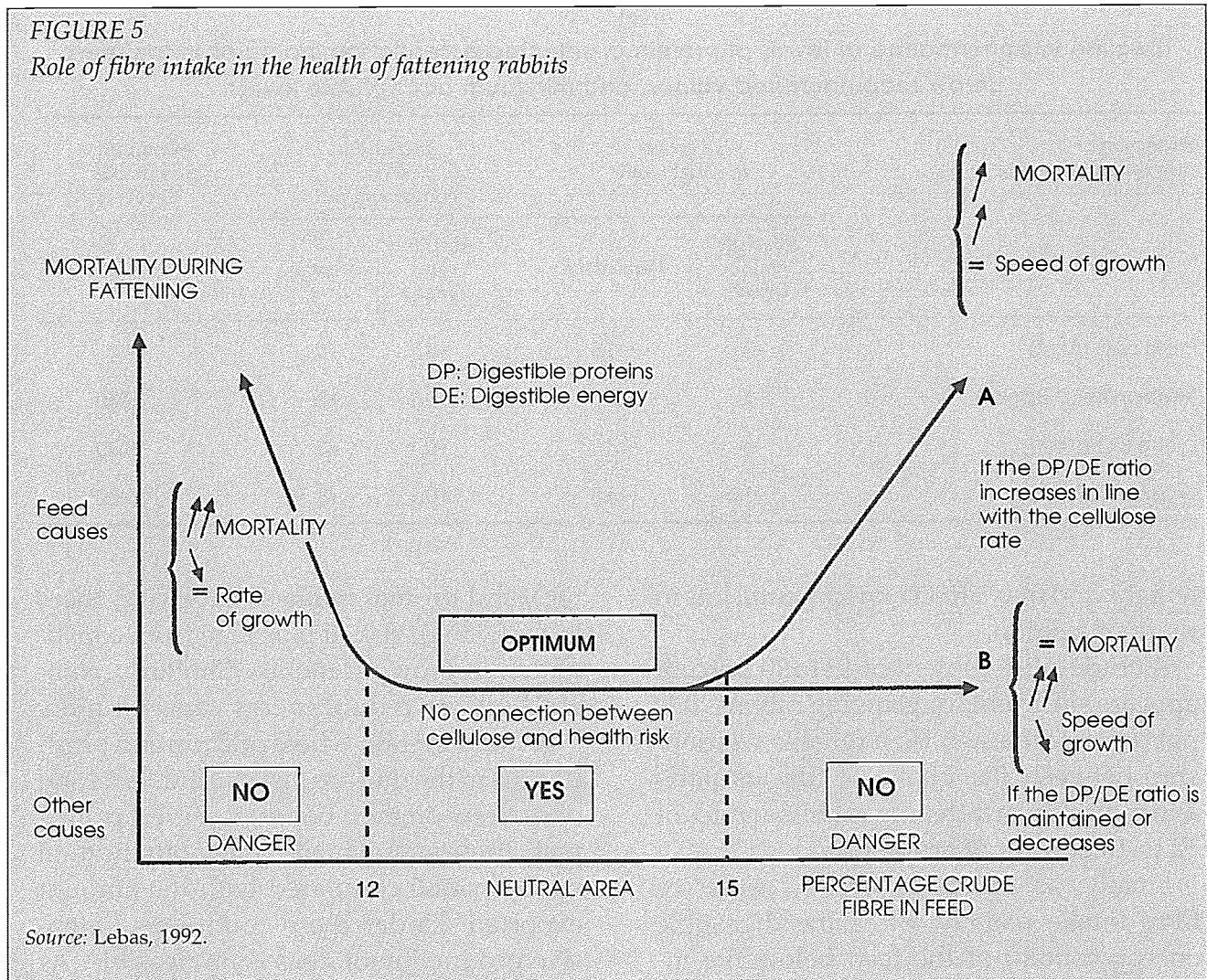

feed are recommended in this case. The norms proposed in Table 22 can be used as a reference method of using complementarities meeting the animals' needs.

#### Feed manufacture and storage

In Europe, rabbits are fed dry raw materials which complement one another to make a balanced feed. Once the best proportions have been established, the raw materials are weighed and put in a blender. They are usually first crushed into meal for a uniform feed mixture. If the mixture were intended for feeding chickens or pigs it could be given to the animals at this stage, but the rabbit has a very low tolerance for the dust inevitably present in meal. This problem is solved by compacting the mixture in a pelleting machine.

The ideal diameter for ordinary feeds is 3 to 4 mm, 5 mm being the maximum diameter to avoid waste (Table 25). The pellets should be no longer than 8 to 10 mm. The pelleting operation heats the product through friction, which improves nutritional value by some 5 to 7 percent compared with the meal mixture.

Using certain recipes rabbits can actually be fed feed in meal form (Table 26). What must be avoided at all costs is a very fine meal which would disturb the normal functioning of the rabbit's upper respiratory tract which, although a good filter for dust, clogs quickly. Meal must not be given as feed where rabbits drink from receptacles containing water. The water will soon get dirty and the rabbits will immediately stop drinking and eating. A valve-type auto-

TABLE 24  
Recommended limits for the incorporation of various minerals, vitamins and selected amino acids in rabbit feed

	Deficit	Observed minimum with no problems	Optimum	Observed maximum with no problems	Toxicity symptoms	Stage
<b>Minerals (ppm)</b>						
Calcium	700 3 000	3 000 8 000	4 000 12 000	25 000 19 000	40 000 25 000	Growth Reproduction
Phosphorus	1 200 4 000	2 600 4 500	3 000 6 000	8 000 8 000	- 10 000	Growth Reproduction
Sodium	-	2 000	3 000	6 000	7 000	Growth
Potassium	3 000 -	6 000 -	6 000 9 000	16 000 16 000	- 20 000	Growth Reproduction
Chlorine	1 700	2 500	3 200	4 200	-	Growth
Magnesium	200	-	2 500	3 500	4 200	Growth
Manganese	- 0.6	- -	8.5 13.0	- -	50 -	Growth Reproduction
Iodine	- -	- -	0.2 0.2	- -	10 000 100	Growth Gestation
Fluoride	-	-	0.5	-	400	Growth
Copper	2	3	5	150-200	200-300	Growth
Zinc	2	7	50	85	-	Growth
<b>Vitamins (/kg)</b>						
Vitamin A (IU)	-	3 000	10 000	20 000	75 000	Reproduction
Vitamin D (IU)	-	600	1 000	2 000	3 000	Reproduction
Vitamin E (mg)	17 17	- 25	50 50	- -	- -	Growth Reproduction
<b>Amino acids (g/16 gN)</b>						
Lysine	2.50	3.75	4.40	7.5	9.4	Growth
Sulphur AA	2.50	3.00	3.75	4.4	5.0	Growth
Arginine	3.00	3.75	5.60	12.5	-	Growth
Tryptophane	-	0.75	0.80	1.60	-	Growth

matic watering system is recommended where meal is fed. Feeding tests on mash (60 percent meal, 40 percent water) show it is feasible provided the feeding racks are kept scrupulously clean (Table 26).

In Europe, depending on local condi-

tions and the size of the production unit, feed is usually delivered in 25 to 50 kg bags or in bulk. Bags are stored in a shed providing shelter from high temperatures and rain, and located near the rabbits but out of their reach. They are stored in piles away

TABLE 25  
Influence of pellet diameter on growth<sup>1</sup> of Californian rabbits aged from 5 to 12 weeks

	Diameter of pellets (mm)		
	2.5 mm	5 mm	7 mm
Feed consumption (g/day)	117 <sup>a</sup>	122 <sup>a</sup>	131 <sup>b</sup>
Weight gain (g/day)	32.4 <sup>a</sup>	33.7 <sup>a</sup>	32.0 <sup>a</sup>
Feed conversion rate	3.7 <sup>a</sup>	3.7 <sup>a</sup>	4.1 <sup>b</sup>

<sup>1</sup> On the same line, two values having the same index letter do not differ from one another at the threshold  $P = 0.05$ .

Note: The apparent overconsumption of 7 mm diameter pellets is due to inevitable partial waste.

Source: Lebas, 1971b.

TABLE 26  
Effect of presentation of feed on growth of young rabbits, according to various authors

Author	Presentation	Feed intake (g DM/day)	Live-weight gain (g/day)	Feed conversion rate (in DM)
Lebas, 1973 <sup>1</sup>	{ Meal	82	29.7	2.78
	{ Pellets	94	36.0	2.62
King, 1974 <sup>2</sup>	{ Meal	79	20.7	3.80
	{ Pellets	85	22.9	3.70
Machin <i>et al.</i> , 1980 <sup>3</sup>	{ Meal	102	26.5	3.80
	{ Mash (40% water)	78	27.9	3.06
	{ Pellets	104	33.1	3.30

<sup>1</sup> Ration composed of 58.8 percent maize, 25 percent soycake, 15 percent barley straw, 0.2 percent dl-methionine, 4 percent minerals and vitamins.

<sup>2</sup> Ration composed of 10 percent fishmeal, 20 percent grass meal, 40 percent wheat bran, 12.5 percent oats, 17.5 percent middlings; in addition, 1.5 percent molasses was mixed with the pellets.

<sup>3</sup> Ration composed of 62 percent barley, 17.5 percent soycake, 12.8 percent barley straw, 5 percent molasses, 0.25 percent lysine, 0.05 percent methionine, 0.3 percent minerals. The test was run at 25°C.

from damp ground or walls. The usual solution is a false wooden floor.

The room or shed is designed to hold one and a half to two months' supply. Deliveries should actually be made monthly, so feed can be used within one and a half months of manufacture. At delivery, about 10 to 15 days' supply should be left over from the previous month.

For bulk delivery, feed is stored in silos that are filled from the top and emptied from the bottom. They should be completely emptied and disinfected for bacteria, fungi, etc. at least once a year.

Transport costs and, especially, a desirably fast turnover of feed stocks make mixed feed (see Table 22) appropriate for rabbitries with fewer than 200 breeding does. In

units with more than 300 does it is preferable to use two or three types of feed: one suitable for lactating and breeding does, one for the weaning period and the last for growing rabbits in all other categories (e.g. young growing rabbits).

## FEEDING SYSTEMS

### Balanced pelleted feeds

The traditional European diet for rabbits used to be cereals, bran and forage (green in summer and dried in winter). In winter, breeders also fed the animals fodder beets or carrots. This style of feeding is definitely on the way out, especially in the big producer countries such as France, Italy and Spain.

In modern production systems, which account for most of the output, the animals

are given balanced pelleted feeds conforming to the standards already described. A single feed type is generally used for all categories, corresponding to the mixed feed listed in Table 22. In intensive-reproduction rabbitries, all rabbits except bucks are fed ad lib. Under less intensive regimes, does receive the same feed ration from the weaning of one litter to the birth of the next. The ration is normally 3 to 35 g DM per kg of live weight per day.

Growing rabbits raised in a group are always fed ad lib. One watering point is sufficient for 10 to 15 animals. The watering system must be checked regularly to ensure the animals do not suffer from lack of water because of defective apparatus. One feeding rack is enough for six to ten rabbits, but at least two are needed as a safety measure in case the pellet flow should get blocked. Each feeding place along the rack should be 7 to 8 cm long.

Breeders calculate the quantities of feed for total daily consumption for all animals as follows:

- young fattening rabbits (four to 11 weeks): 110 to 130 g;
- lactating does with litters (weaning at four weeks): 350 to 380 g;
- adult (maintenance) rabbits: 120 g;
- for the rabbitry as a whole: 1 to 1.4 kg of feed per mother cage per day.

Well-run rabbitries, as in France or Italy, calculate 3.8 kg of pelleted feed consumed for each kg of live weight marketed. This calculation includes breeding rabbits. The best rabbitries use only 3.4 kg of feed to produce 1 kg live rabbit. This represents a feed expenditure of 5.9 to 6.7 kg per kg of carcass. Keeping in mind the protein content of the feed and the carcasses, this means a yield of 190 to 220 g of high-grade animal protein from 1 kg of plant protein, a return of 19 to 22 percent for the best production units.

#### **Forage utilization in developing countries**

Pilot trials in Germany have demonstrated

that growing rabbits enclosed or penned in a natural meadow receiving no fertilizer can produce 240 kg of protein per hectare (1.2 tonnes of meat) annually in the form of carcasses. This gives some idea of the forage utilization potential of rabbits, although in the trials the rabbits exhibited a modest growth rate (20 to 25 g a day compared with the 30 to 40 g of cage- or hutch-raised rabbits) and a relatively high feed intake.

Climate and soils in most developing countries, however, are very different from those found in Germany. Direct grazing also poses problems of fencing and risks from predators to the point where this technique cannot be recommended. For this reason the authors have reviewed the various wild or cultivable plants used in both tropical and non-tropical regions to feed rabbits reared in confinement. Cereals are intentionally left out as they are needed for human nutrition in most developing countries.

Before reviewing the various plants which rabbits can use, a reminder is needed of rabbits' extreme sensitivity to mould, particularly aflatoxin. The hygiene of the fodder and by-products used must be beyond reproach and it is particularly important to avoid uncontrolled fermentation.

*Wild and cultivated fodders suitable for rabbit feed.* The following information only concerns plants that have been positively tested in station and other trials for use as rabbit feed. They are listed under their Latin names in alphabetical order. The countries where they are used are indicated where possible.

A "high" nutrient value means the feed has a higher dry matter content than is required for rabbits. Unless otherwise indicated, nutrient content, where shown, is expressed as a percentage of dry matter. For detailed chemical compositions, readers should refer to the general documents in the bibliography, particularly Göhl's

work on tropical forages published by FAO (1982). Digestibility of the nutrients has not usually been determined for the rabbit specifically. Lacking these data, references should be made to forage digestibility for ruminants, but absolute values cannot be transposed, especially for the fibrous fraction.

*Alysicarpus vaginalis*. A one-leaf clover distributed ad lib to growing rabbits as a supplement to concentrates gave performances not significantly different from the control. This plant, grown in South America, is a good source of protein.

*Amaranthus* spp. This forage has a 20 percent protein content. It has been tried out in Malawi to supplement a concentrate containing 39.5 percent grain maize, 26 percent maize bran, 34 percent groundnut oilcake and 0.5 percent table salt. Reproduction and growth were satisfactory: 20 rabbits per doe per year; growth of 15 g per day from four to 16 weeks. *Amaranthus* is routinely fed to rabbits at the Bunda Agricultural College in Lilongwe, Malawi. Modern hybrid varieties conventionally grown for human food can also be used for feeding rabbits.

*Arachis hypogaea*. Groundnut oilcake is a high protein feed (50 percent). It can be used for feed when not overpolluted by aflatoxins. The whole groundnut can also be fed, but this puts the rabbit into direct competition with people for food so this solution should only be considered under exceptional circumstances. Groundnut tops provide green fodder and hay with a high protein content. This is the conventional use at the Bobo-Dioulasso centre in Burkina Faso. The tops can also be used after harvest, but their protein content is less: about 15 percent before the groundnuts are removed and less than 10 percent after threshing. The proteins in both the tops and the groundnut cake lack the essential sulphur amino acids.

*Azolla* spp. This family of aquatic ferns can fix atmospheric nitrogen. Trials in Italy

have shown that *Azolla caroliniana* can be incorporated into rabbit feed despite the poor digestibility of the proteins. Other Italian trials on *A. filiculoides* produced similar conclusions in a trial where this sun-dried fern fully replaced soy cake in the ration at 23 percent. However, the protein content of azolla (30 to 32 percent) is less lysine-rich than soy (4.5 as compared to 5.9 percent protein) and the lignin content is high, reducing digestibility. *A. microphylla* is comparable to *A. caroliniana* but *A. pinnata*, with a lower protein content of 9 percent, is not as palatable.

*Bauhinia variegata*. Angora rabbits are successfully fed the leaves of this tree as a supplement to concentrates in India. The protein content is 16 percent.

*Beta vulgaris*. Fodder and fodder sugar beets supply much of the winter feed in traditional European rabbit production. Where they can be grown, beets can supply a good percentage of the energy demand. The fibrous fraction is highly digestible (80 percent). Beet leaves are also good for rabbits. They contain 17 to 18 percent protein, but are very rich in minerals, especially potassium, which can cause digestive problems.

*Brachiaria mutica*. Fed to breeding does in the Philippines, para grass has proved far more satisfactory than elephant grass (*Pennisetum purpureum*) or guinea grass (*Panicum maximum*). However, its low protein content (10 to 13 percent) requires a nitrogen supplement (legumes, supplementary feed).

*Brachiaria ruziziensis*. In Burkina Faso this forage plant is part of the basic ration produced at the Bobo-Dioulasso centre for its rabbitry. Like all grasses, however, it has a low protein content (8 to 13 percent). For proper utilization it should be supplemented by high-protein feeds. The forage could be grown together with *Stylosanthes*, for example, for a more balanced feed than either plant can provide alone.

*Cajanus cajan*. Hay from this tree legume (called "guandu" in Brazil) can successfully be incorporated into balanced feed for growing rabbits as a substitute for alfalfa hay. Pigeon pea hay thus constitutes an interesting source of protein (15 to 25 percent depending on when it is harvested) and fibre (30 to 35 percent crude fibre).

*Celtis australis*. The leaves of this tree are used to feed Angora rabbits in India. Compared with the dry-matter content, the protein content is low at 12.4 percent as is crude fibre at 14.6 percent, but the fat content is fairly high at 5.7 percent and the 17.7 percent ash content is quite high.

*Chamaecrista aescynomene*. This tropical legume is commonly used to feed Creole rabbits in Guadeloupe and Martinique.

*Cocos nucifera*. Rabbits like the green coconut meat left after the milk has been drunk. In Guadeloupe and Martinique they are fed to rabbits as a bulk dietary supplement. A trial on growing rabbits in Sri Lanka showed that coconut could form 20 or even 30 percent of the diet.

*Cucurbita foetidissima*. Growing naturally in the semi-desert area of northern Mexico, this member of the gourd family has an enormous root that is 65 percent starch. The crushed root is sun-dried in two or three days and as much as 30 percent can be added to balanced concentrate in place of grain sorghum for breeding and fattening rabbits. Trials at the University of Chihuahua in Mexico demonstrated no toxic effect.

The tops and especially the fruit are rich in protein (12 to 30 percent), but utilization trials have not yet been run on rabbits. Their very bitter taste, which is unattractive to other animals, is not necessarily an obstacle for rabbits. More tests are needed on the possibilities of this interesting semi-desert plant.

*Daucus carota*. A traditional feed for European farm rabbits, carrots can be grown in many tropical countries. They are used

in Zambia, in particular, to feed rabbits. Both leaves and roots have a comparable protein content of 12 to 13 percent, but the leaves – like beet leaves – are very rich in minerals.

*Dendrocalamus hamiltonii*. The leaves of this tree have been successfully used to feed Angora rabbits in India as a supplement to commercial concentrates. The protein and crude-fibre contents of 15.6 and 23.2 as a percentage of dry matter are fairly low, but the 18.4 percent ash content is particularly high.

*Eichhornia crassipes*. Rabbits will eat the leaves and bulbs of water hyacinth, but only 24 percent of the energy provided by the green plant is digestible. Incorporating 25 percent water hyacinth meal in a balanced feed gives good results. Amounts of 50 percent or more are less satisfactory. The arsenic content of the rabbit meat (especially the liver and kidneys) in water hyacinth trials raised grave doubts about the plant's potential for feeding rabbits where it grows in polluted water.

In rabbitries located near the Congo River in the Democratic Republic of the Congo, breeders use a local water hyacinth of which the rabbits are very fond. In New Caledonia, a local hyacinth called water lily is also a traditional feed. The whole of the plant – stem, bulb and roots – is eaten.

*Erythrina glauca*. Rabbits find the leaves of this tree very palatable. A trial in Colombia showed that this (30 percent) protein source produced daily growth rates of 11.5 g as a simple supplement to sugar-cane juice. The proportion of *Erythrina* leaves actually rose from 50 percent of the daily DM consumption at the onset of the trial to 65 percent eight weeks later.

*Grewia optiva*. The leaves of this tree contain about 17 percent protein. An Indian ad lib feeding trial to supplement a concentrate produced an Angora wool output equivalent to that of the control fed the concentrate alone.

*Gynura cusimba*. The leaves of this forage plant, abundant in Nepal in the dry season, contain 27 percent protein. Rabbits like it but cattle, sheep and goats will not touch it. This difference in feed preferences is a reminder that observations valid for one species do not necessarily apply to another.

*Hibiscus rosa-sinensis*. The branches of these shrubs, which are used as living fences in the Caribbean, can be fed to rabbits, as is now the practice in Haiti. The young shoots contain some 15 percent protein and 16 percent crude fibre. However, a trial on ad lib distribution of hibiscus leaves and a balanced pelleted feed demonstrated very poor nutritional uptake of this fodder.

*Indigofera arrecta*. This legume grows wild in Mozambique, even during the dry season without irrigation. It is easy to grow from the seeds of the wild plant picked in season. Its high (25 percent) protein content makes it a valuable source of nitrogen for rabbits in Mozambique, especially during the dry season.

*Ipomoea batatas*. Sweet potatoes are a good source of energy (70 percent starch content) for human consumption and can easily be grown in a family garden. Surplus or specially grown crops could be used as an energy feed for rabbits. The tops when well developed are also a valuable feed because of their high protein content – 16 to 20 percent. Sweet potato is used as forage for rabbits in Mauritius, Guadeloupe and Martinique, mainly in backyard rabbitries. A trial in Mozambique produced good performance with sweet potato leaves as a dietary supplement. They are highly digestible, and trials in many tropical countries have confirmed the nutritional value of sweet potato tops.

*Ipomoea tiliacea*. This convolvulacea grows wild in Guadeloupe and Martinique and is the traditional basic feed for creole rabbits. It is not planted but simply picked from the hedges where it grows wild.

*Lathyrus sativus*. Vetch is often grown with oat in North Africa; the vetch/oat duo

is used as green fodder for livestock and rabbits like it very much. In ad lib feeding with concentrated feed, it produced acceptable growth or reproduction rates. Much of the food value is lost when the product is stored, however, and rabbits tend not to like it.

*Lespedeza* spp. These legumes, which provide a protein-rich green forage for rabbits, could also be dried and fed as hay.

*Leucaena leucocephala*. This is probably the legume most studied in station rabbit trials. Its attraction is its high protein content (28 percent) and the fact that it can be grown during the dry season. Sowing and tillage are no problem in soils where *Leucaena* grows naturally (e.g. Mauritius). In the absence of symbiotic bacteria, bacterial seeding can be used (Guadeloupe and Martinique).

The presence of the amino acid mimosine, which competes with tyrosine and phenylalanine, is to some authors a limiting factor for *Leucaena leucocephala*. They suggest that a prudent top ration of this acacia for rabbits would be 25 percent (Mozambique). But growth trials on the island of Mauritius show that *Leucaena* can replace 40 and even 60 percent of balanced feeds without adversely affecting animal growth or health (Figure 6). In these trials, even where this acacia was used alone, the authors noted no incidence of diarrhoea or symptoms attributable to mimosine.

Other trials in Malawi used *Leucaena* as a supplementary fodder for a concentrate feed (described in the paragraph on *Amaranthus*) with good results for both growth and reproduction. Also tested in Malawi as a maize bran supplement, *Leucaena* proved satisfactory for growth (60 g a week) and better than *Tridax procumbens* and, especially, *Pennisetum purpureum*. Used as a supplement to a broiler chicken feed, growth rates of 100 to 110 g a week were recorded.

Despite these encouraging results the problem of mimosine remains. Mimosine



FIGURE 6

Weight-gain trends in New Zealand White rabbits aged from 6 to 14 weeks in relation to intake of balanced feed\*

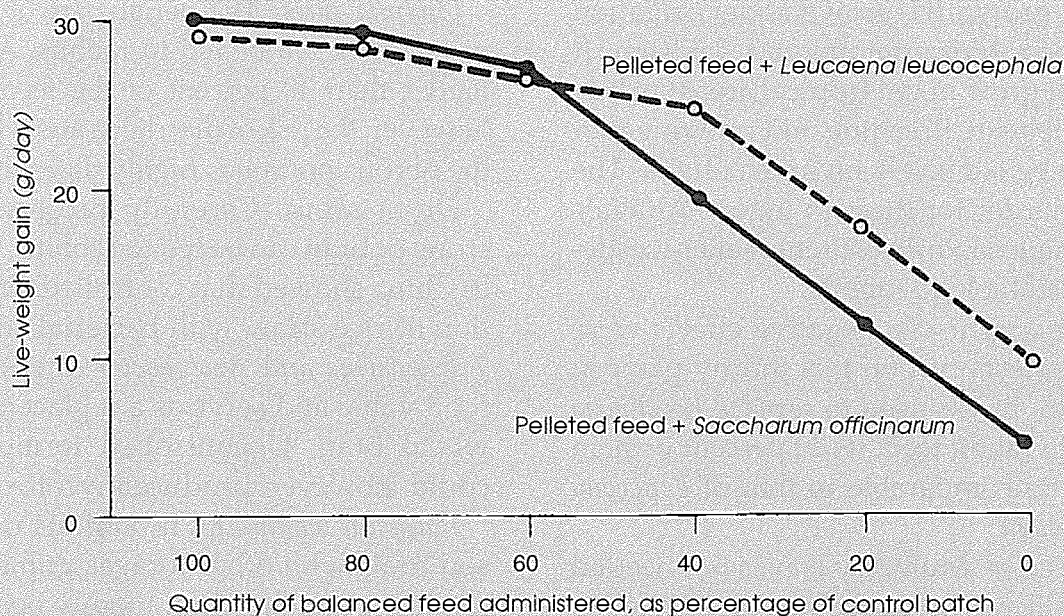

\* Limited quantities of control diet, supplemented by ad lib feeding of *Leucaena leucocephala* (○—○) or *Saccharum officinarum* (●—●).  
Source: Ramschurn, 1978.

toxicity is cumulative and perhaps did not show up in the growth trials, even though these covered the entire fattening period. Several continuous trials in Mauritius, Togo and Malawi, using *Leucaena* at levels of 10 and 20 percent, have not had any ill effects on growth or reproduction. As mimosine is an amino acid, drying the forage does not reduce its toxicity to animals, although no special rabbit trials have been run on this aspect. The addition of iron sulphate chelates mimosine and considerably reduces toxicity for rabbits as intestinal absorption of the chelated form of mimosine is significantly diminished. The iron sulphate supplement should exceed the mimosine content by a factor of four, comprising 2 to 3 percent of the diet.

*Manihot utilissima*. Ghana's rabbit development programme includes growing cassava for feed. The inclusion of from 15 to 45

percent cassava meal (87 percent starch and 2.5 to 3 percent protein) in balanced feeds, supplemented by 200 g green forage daily, has given growth and reproduction results comparable to those obtained with the balanced control feed without cassava. But cassava should not be used to feed rabbits except where the human population already has plenty of energy foods, as in Egypt, for example. Additionally, cassava meal requires a protein and crude-fibre supplement. However, cassava peels contain 6 percent protein and 10 percent crude fibre, and the leaves contain 24 to 28 percent protein, so the potential of these two cassava products for rabbit feed should be tested in comparative trials. Cassava does have a slight tendency to produce goitre, which has no practical impact on growing rabbits but is a potential concern for breeders if it comprises over 30 percent of the diet.

*Marremia tuberosa*. This protein-rich (24 percent) forage, used in Mozambique to feed rabbits, grows during the dry season.

*Medicago sativa*. Alfalfa is unquestionably the standard rabbit forage, wherever it can be grown. It is grown under irrigation in Mexico, Mozambique and Pakistan. It does not grow in hot tropical areas such as the Caribbean. Breeding and growing rabbits can be fed solely on green alfalfa. The hay is harder for them to ingest. Alfalfa's rather high saponin content makes it especially palatable to rabbits.

*Mimosa pigra*. No negative effects were noted in tests run on this thorny plant in Thailand. It was used to replace *Brachiaria mutica* in rabbit feed. Its 22 percent protein content is comparable to that of *Leucaena leucocephala*.

*Morus alba*. Mulberry leaves not needed to feed silkworms can be successfully fed to rabbits. Trials in India have even shown that a maintenance diet for adult rabbits can consist exclusively of mulberry leaves. They are used in India to supplement concentrates for Angora rabbits.

*Musa* spp. Rabbits can be fed on commercial banana rejects. Bananas are rich in energy and poor in protein (5 or 6 percent) and must be supplemented. Rabbit breeders use banana rejects in various African countries and in Guadeloupe and Martinique. The leaves can also be used as green forage (Cameroon, Zambia, Guadeloupe and Martinique). Their protein content is 10 to 11 percent of the dry matter. Data are available on the leaves as rabbit feed, but not on the stems. They contain only 1.5 to 2 percent protein and with a 70 percent nitrogen-free extract could make a useful energy feed. Banana peels can also be used to replace up to 35 percent of the concentrate for growing rabbits.

*Neotonia wightii*. A trial in Brazil showed that perennial soybean hay can fully replace alfalfa in a balanced ration containing 38 percent of this forage. There is even

a marked improvement in the growth rate (41.5 g/day compared with 37.1 g/day with control rabbits fed alfalfa). This legume can be an attractive source of protein and fibre for rabbits.

*Opuntia ficus*. The aerial part of prickly pear cactus can be fed to rabbits. At levels higher than 40 percent of the feed ration, however, the risk of diarrhoea arises because the fibrous portion is highly digestible.

*Oryza sativa*. Carefully preserved rice straw or bran can be fed to rabbits. A study in China showed that controlled fermentation of rice straw with bacterial strains of *Trichoderma* and *Azotobacter* can boost the food value and serve as a replacement for wheat bran. Uncontrolled fermentation could, however, produce mycotoxins.

*Panicum maximum*. In various comparison trials with other forages guinea grass made a poor showing, mainly because of its low protein content – 5 to 10 percent of the dry matter according to ripeness. Despite this, guinea grass is part of the basic feed ration for rabbits in Ghana, Guadeloupe and Martinique. Its function is mainly to provide crude fibre and a small amount of energy. There is another use for guinea grass: dried, the plant is sometimes used as straw litter for the nest box when breeding does are raised on a mesh floor.

*Pennisetum purpureum*. Feed trials with breeding and growing rabbits using elephant grass gave even poorer results than guinea grass, again because of low protein content (6 to 8 percent). A Malawi trial using elephant grass as a supplement for maize bran produced growth rates of only 15 g a week compared with 60 g with *Leucaena leucocephala*; but it can be used as a source of crude fibre for rabbits, as is done in Guadeloupe and Martinique. A mixed crop where elephant grass supports a climbing legume such as *Pueraria* is planned in the Democratic Republic of the Congo. The combination gives a much more balanced forage. The dried stems of *Pennisetum* can

be used as straw litter or bedding for the nest box.

*Pistia stratiotes*. Comprising 30 percent of the diet of growing rabbits, sun-dried water-lettuce meal was used in Nigeria to produce growth rates equal to those of the control.

*Populus* spp. Green poplar leaves can be used to replace sun-dried alfalfa leaves as a fodder resource for rabbits. The leaves of the older trees are less protein rich (15 percent of the DM) than the leaves of coppiced poplars (20 to 22 percent of the DM). Trials in the United States used up to 40 percent poplar leaves in the diet.

*Prosopis chiliensis*. The fruits of this drought-resistant South American native have been introduced in Chile as a supplement to balanced rabbit feed, replacing up to 60 percent of the protein in the basic diet. Growth remained unchanged even when the feed contained up to 29.4 percent of the dried *Prosopis* fruits.

*Psilotricum boivinianum*. This forage grows without irrigation in the dry season in Mozambique and has a high (20 to 21 percent) protein content, making it an attractive forage feed for rabbits.

*Pueraria* spp. The legumes of this genus, such as *P. phaseoloides* and *P. javanica*, are recommended as rabbit feed in different countries of Africa, especially Ghana. *P. javanica* is the basic feed of many farm rabbitries in the Democratic Republic of the Congo. Rabbits are very fond of it. Like *Stylosanthes*, *Pueraria* remain green even in the dry season.

*Robinia pseudoaccacia*. Various trials in the United States and India on growing or on Angora rabbits showed that *Robinia* leaves can easily replace alfalfa in the diet with only a slight drop in performance.

*Saccharum officinarum*. Sugar cane can be grown in countries with wet tropical climates and is a good rabbit feed, despite its low protein content (1 or 2 percent). In an early trial in Mauritius, coarsely chopped sugar cane was successfully used to re-

place one half the balanced concentrate feed ration with no consequent drop in performance. In a complementary trial, the same authors found that, fed ad lib, rabbits chose to replace up to 40 percent of their balanced concentrate feed with chopped sugar cane. In a similar ad lib feeding test, *Leucaena leucocephala* replaced up to 60 percent of the same balanced concentrate feed (see Figure 6). In a New Caledonia trial it was shown that rabbits prefer to eat first the dry leaves, then the green leaves and then the cane itself, chopped small.

*Setaria* spp. These species of forage are used in Mauritius to supplement concentrated feeds for rabbits. Like all grasses, *Setaria* are poor in proteins.

*Solanum tuberosum*. Cooked potatoes can very well be used to feed rabbits, but this puts the animals into competition with humans for food. Potato peelings are part of the kitchen waste in many countries and can be used in feed. However, apart from the fact that the peelings should be fed cooked, not raw, great care must be taken not to use the parings of potatoes which have turned green with exposure to light. Laboratory animals stopped growing when they were given 20 g of green potato peelings a day in addition to their normal feed ration.

*Sorghum vulgare*. Sorghum tops and grain are a good rabbit feed. They are used in Ghana and Mexico.

*Stylosanthes* spp. Legumes of this genus can be grown in all wet and dry tropical climates. In dry areas they virtually stop growing during the dry season, but remain green. Different species have been used for rabbits, including *S. gracilis* (Ghana, the Democratic Republic of the Congo, Burkina Faso) and *S. hamata* (Martinique).

*Taraxacum officinale*. The dandelion is among the wild plants conventionally fed to rabbits in traditional European rabbit production. The use of this composite plant as rabbit feed has also been reported in Togo.

*Tridax procumbens*. Considered a weed on the Malawi grasslands, the advantage of *Tridax* is that it grows during the dry season. Its 12 to 13 percent protein content also makes it a good rabbit feed. The plant proved satisfactory as a concentrate feed supplement in Malawi. Growth performance trials with *Tridax* as a maize bran supplement, however, were poorer than trials with *Leucaena leucocephala*, although more promising than *Pennisetum purpureum*, probably because of the differing protein content of the three plants.

*Trifolium alexandrinum*. This Egyptian clover (berseem), typical of the Mediterranean climate, is virtually the only rabbit feed used in the Sudan. Feeding trials in Egypt using the clover alone produced live weights of 1.23 kg at 16 weeks for cross-bred Baladi x Flanders Giant rabbits, with an average weekly gain of 67 g. Like all legumes this clover variety has a high protein content.

*Vicia* spp. Wild vetches, grown alone or interplanted with grasses, can supply a protein-rich forage attractive to rabbits. The plant grows so quickly, however, that the tendency is to use it as hay, unless planting can be staggered for a continuing crop.

*Vigna sinensis*. These wild peas of Guadeloupe and Martinique supply nitrogen-rich green forage and grain. Both *V. sinensis* and *V. unguiculata* are used as rabbit feed in these islands.

*Zeamays*. Although maize grain is needed as food for people in most developing countries, its use as fodder would be feasible in certain regions. The protein content of maize forage is low, so it requires a nitrogen supplement. Maize is used as forage in Burkina Faso, for instance.

This rather lengthy list of plants that have been tested as rabbit feed does not include every usable plant. There are grasses such as the various species of *Digitaria*, for example, although these are usually poor in protein. Where cabbage can be grown it should be added to the list. Cabbage is a traditional

rabbit feed in France. Its 17 to 20 percent protein content is fairly high. Trials in Cameroon suggest that cabbage can form up to 15 percent of the diet.

#### *Agricultural and industrial by-products.*

The various agricultural and industrial by-products will not be reviewed here, as lists of by-products and their composition are usually available for each region. Only a few need special mention. First come the various tropical oilcakes such as groundnut (already described), palm nut and coconut. Cottonseed cake should be used very cautiously, as rabbits are at least as sensitive as pigs to gossypol. However, cottonseed cakes containing up to 700 ppm of free gossypol have been fed to growing rabbits with no problems. In many countries where cottonseed feedcake is available, it is preferable to use it and to accept a drop in performance of 10 to 15 percent compared with a gossypol-free ration rather than attempt to introduce livestock-based meal as a protein source which may be expensive or of poor bacteriological quality. Then there are maize and rice by-products. Brewer's draff and citrus pulp are possible feed sources where the processing plants are not too far from the rabbitry. Rabbits can also be fed waste products from pineapple canneries, as in Côte d'Ivoire, but pineapples are poor in protein.

Brewer's draff from the manufacture of barley-based beer and dolo dregs from millet beer can produce good results. In a test conducted in Burkina Faso, dolo dregs were used as 80 percent of a concentrate feed with 10 percent groundnut cake, 6 percent blood meal and 4 percent bone meal. This was fed with a forage supplement of green *Brachiaria* or dried groundnut tops. Local rabbits grew faster with this feed (104 g a week with land race) than with an imported balanced feed (83 g). Sun-dried brewer's draff is often also incorporated as a protein source for rabbit rations in the urban peripheries of some African cities.

## Chapter 3 Reproduction

### ANATOMY OF THE GENITALS

In the male, the oval-shaped testes within the scrotum remain in communication with the abdominal cavity, where they were at birth. The rabbit is actually able to withdraw its testes when frightened or fighting with other males. The testicles descend at about two months. The short, back-slanting penis points forward when erect. Figure 7 shows the relative position of the various organs.

In the female, ovaries are oval-shaped and do not exceed 1 to 1.5 cm. Beneath the ovaries is the oviduct, made up of the duct, the ampulla and the isthmus. Although outwardly the uterine horns are joined at the back into a single organ, there are actually two independent uteri of about 7 cm, opening separately through two cervical ducts into the 6 to 10 cm vagina. The urethra opens midway along the vagina at the vaginal vestibule. The glands of Bartholin and the preputial glands can be identified. The whole is supported by the broad ligament attached at four main points under the vertebral column.

Figure 8 shows the relative position of the various organs.

### REPRODUCTION PHYSIOLOGY

#### The male

**Gonad development and puberty.** The gonads begin to differentiate on the 16th day after fertilization. After birth the testes develop less quickly than the rest of the body. From the age of five weeks they begin to grow very rapidly. Accessory glands undergo a similar development, but at a more even rate and are less precocious.

Spermatogenesis begins between days

40 and 50. The testicular tubes become active at about 84 days. The first spermatozoa are present in the ejaculate at about 110 days.

Sexual maturity, defined as the moment when daily sperm production ceases to increase, is reached at 32 weeks by New Zealand White rabbits in temperate climates. However, a young buck in these same conditions can be used for reproduction from the age of 20 weeks. Indeed the first manifestations of sexual behaviour appear at days 60 to 70 when the rabbit makes its first attempts at riding. Coitus may occur for the first time at about 100 days, but the viability of the sperm cells is very weak or nil in the first ejaculates. So first mating should be timed for age 135 to 140 days.

All these figures are to be considered approximate. The onset of puberty varies from breed to breed, but conditions in the rabbitry also play an essential role, particularly feeding, which is even more important than climate.

**Sperm production.** The volume of semen ejaculated is about 0.3 to 0.6 ml. Concentration is evaluated at 150 to 500 x 10<sup>6</sup> spermatozoa per ml, but both volume and concentration are liable to vary. False mountings, one or two minutes before copulation, increase the concentration of the ejaculate. In two successive servicings the first acts as a preparation for the second, which is less voluminous but more concentrated. During subsequent matings the volume of the ejaculate decreases, while concentration increases between the first and the second ejaculate and then diminishes. The total

FIGURE 7

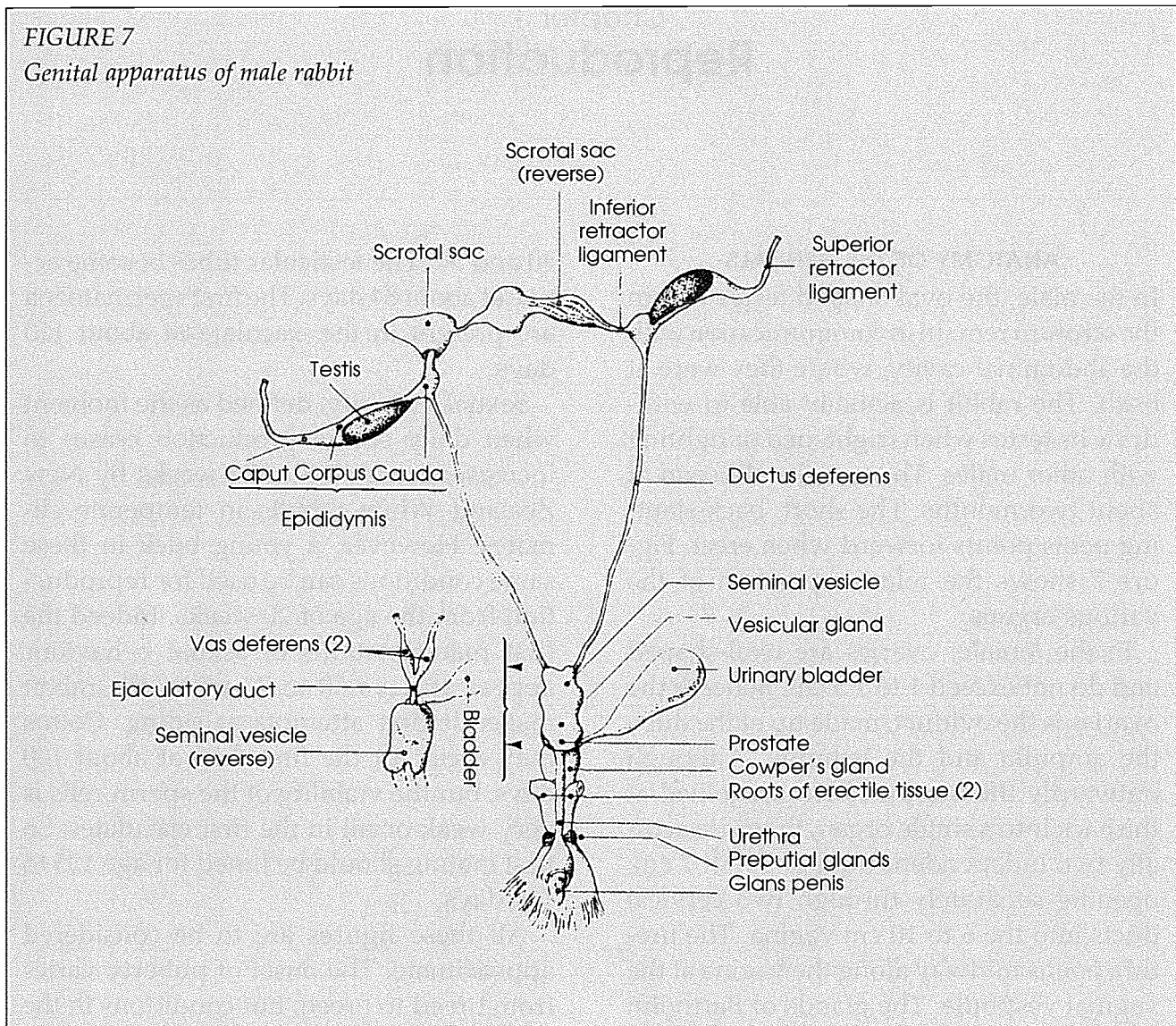
*Genital apparatus of male rabbit*

number of spermatozoa per ejaculate follows the same trend.

Maximum spermatozoa production is obtained by using the buck regularly once a day. If the buck is used regularly twice a day, each ejaculate has only one half the concentration of spermatozoa. On the other hand, if bucks service several times a day, one day a week, the three or four ejaculates may be concentrated enough to effect fertilization. Further ejaculates contain very few spermatozoa and cannot effect fertilization often enough to be worth while. Daily spermatozoa production is roughly 150 to 300 million, independent of the rate of ejaculation. The maximum epididymis reserve is only one to two billion spermato-

zoa, only partially mobilizable for repeated ejaculations.

#### The female

**Gonad development, puberty and sexual maturity.** As in the male foetus, sexual differentiation takes place on the 16th day after fertilization. Oogonial division begins on the 21st day of foetal life and continues until birth.

The first follicles appear on the 13th day after birth, and the first antrum follicles at about 65 to 70 days. Does are able to mate first at 10 to 12 weeks, but as a rule this will not produce ovulation. The onset of puberty varies greatly with:

- the breed: sexual precocity is more de-

veloped in small or medium breeds (four to six months) than in large breeds (five to eight months). In Europe does are now mated at 120 to 130 days and fertility performance is good;

- body development: precocity goes hand in hand with rapid growth. Does fed ad lib reach puberty three weeks earlier than other does of the same strain receiving only 75 percent of the same daily feed. The body development of the latter is also delayed by three weeks.

Does generally reach puberty when they have grown to 70 to 75 percent of their mature weight. However, it is usually preferable to wait until they reach 80 percent of their mature weight before breeding them. These relative weights should not be con-

sidered absolute thresholds for all rabbits, but rather limits applicable to the population as a whole. Sexual behaviour (acceptance of mating) appears long before the ability to ovulate and bear a litter. Such behaviour should not be regarded by the breeder as a sign of puberty, but as pre-puberty play.

**The oestrus cycle.** In most domestic mammals ovulation takes place at regular intervals when the female is in heat or oestrus. The interval between two periods of oestrus represents the length of the oestrus cycle (four days for rats, 17 for ewes, 21 for sows and cows).

The female rabbit, however, does not have an oestrus cycle with regular periods of heat during which ovulation will occur

FIGURE 8  
Genital apparatus of female rabbit

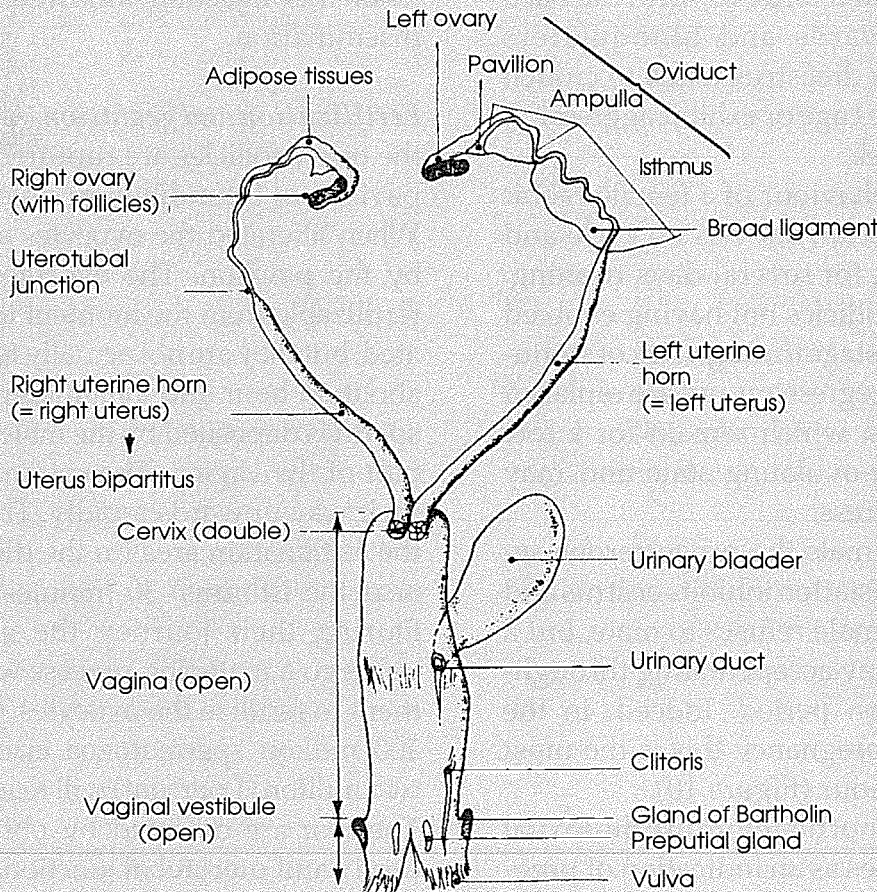

spontaneously. Does are considered to be in oestrus more or less permanently. Ovulation occurs only after mating. A female rabbit is therefore considered to be in heat when she accepts service and in dioestrus when she refuses.

There are many observations which denote the alternating periods of oestrus during which the doe accepts mating and dioestrus in which she refuses (Figure 9). But the present state of knowledge does not make it possible to predict either the respective lengths of oestrus and dioestrus or the environmental or hormonal factors determining them.

It has been noted, however, that 90 percent of the time when a doe has a red vulva she will accept mating and ovulate, whereas when the vulva is not red the doe will accept service and become fertilized only 10 percent of the time. A red vulva is therefore a strong indication, though not a proof, of oestrus. A doe in heat assumes a characteristic pose, called lordosis, with the back arched downwards and hindquarters raised. A doe in dioestrus tends to crouch in a corner of the cage or exhibit aggression towards the buck.

The sexual behaviour of a female rabbit is thus very special. She has no cycle and can stay in heat for several days running. On the ovary, follicles not having evolved to the ovulation stage through lack of stimulation undergo regression and are replaced by new follicles, which remain for a few days in the pre-ovulating state and may then in turn regress.

In most mammals the progesterone secreted during gestation inhibits oestrus and the pregnant female refuses to mate, but a pregnant doe may accept mating throughout the gestation period. Indeed, in the second half of pregnancy this is the most common behaviour (Figure 10).

A breeder cannot therefore use the sexual behaviour of does as an indication of pregnancy. Mating occurring during gestation

has no dire consequences for the embryos. Unlike the phenomenon observed in the female hare, superfoetation (two simultaneous pregnancies at two different stages of development) never occurs in rabbits.

**Ovulation.** Ovulation is normally induced by the stimuli associated with coitus and occurs ten to 12 hours after mating, as outlined in Figure 11.

Given this sort of pattern, ovulation can be induced artificially by various techniques. Mechanical stimulation of the vagina can cause ovulation, but the outcome is quite random. Injections of luteinizing hormones (LH) or LH releasing hormones (LHRH) can produce results, although repeated injections of the LH hormone lead to immunization and loss of effect beyond the fifth or sixth injection. Injections of LHRH repeated at 35 days for two years, however, have involved no loss of effect: 65 to 80 percent of the does became pregnant from this injection followed by artificial insemination.

**Fertilization and gestation.** At the moment the ovary follicles are ruptured the oviduct pavilion or infundibulum covers the ovary. When liberated the ovocytes are sucked in by the pavilion. The ovocytes are in fact fertilizable from the moment they are liberated, but they are not actually fertilized until about an hour and a half after release. The sperm is deposited by the male in the upper part of the vagina. The spermatozoa make their way upwards rapidly. They can reach the fertilization area (in the distal ampulla, near the isthmus) 30 minutes after coitus. During their journey the spermatozoa undergo a maturing process which enables them to fertilize the ovocytes. Of the 150 to 200 million spermatozoa ejaculated, only two million (1 percent) will reach the uterus. The rest are defeated by obstacles at the cervix and uterotubal junction.

The egg reaches the uterus 72 hours after



FIGURE 9

Sexual behaviour and duration of oestrus in five pubescent nulliparous does

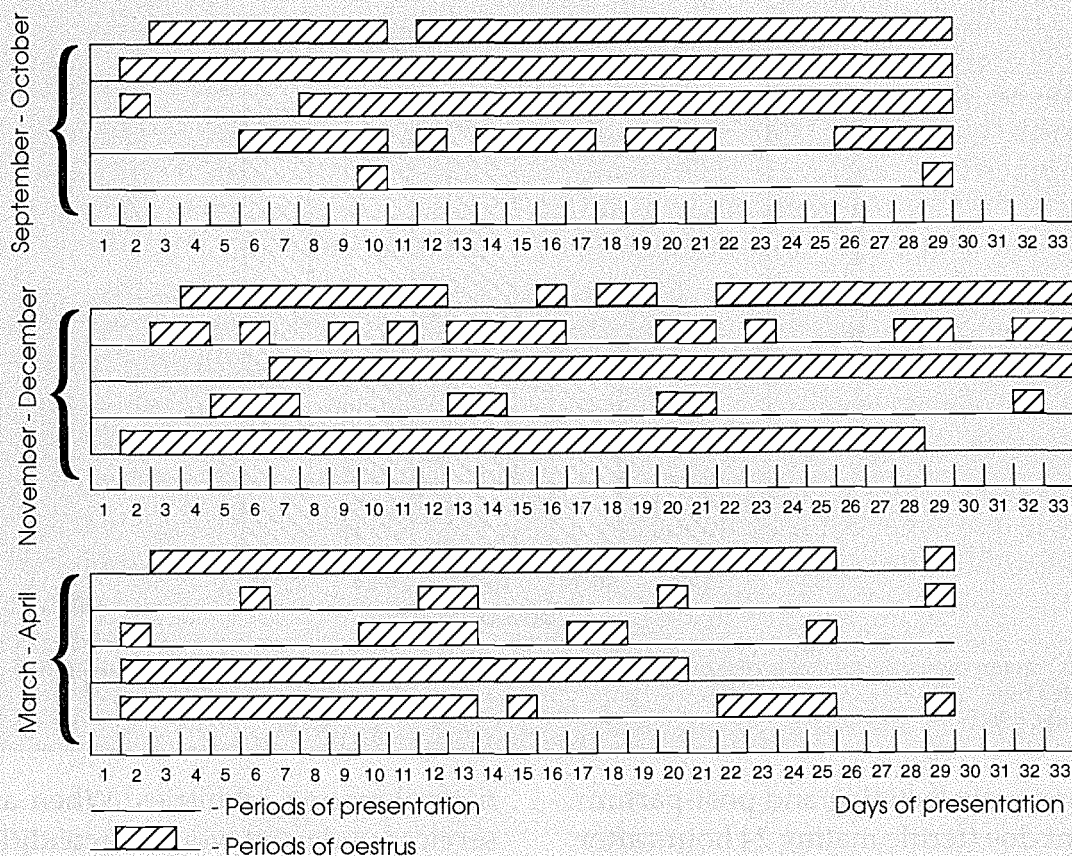

**Note:** For five does tested in three seasons sexual behaviour was checked daily for about a month by presentation to a buck. If the doe accepted mating she was said to be in heat that day (thick line on diagram), but fertilization was prevented to enable the test to be repeated the next day. If she refused, she was said to be not in heat (thin line on diagram) and the test was repeated the next day. It will be noted that the days of oestrus and of dioestrus vary greatly from one doe to another.

Source: Moret, 1980.

ovulation. On its way through the oviduct the egg divides. The uterine wall differentiates, but the uterine dentellus appears only five to eight days after coitus. It is the synchronization of these phenomena that makes possible the implantation of the egg. Implantation proper takes place seven days after mating, at the blastocyst stage. Distribution of the blastocysts is roughly equidistant in each horn, but the blastocysts never move from one uterine horn to the other. From the third to the 15th day after mating the progesterone rate continues to increase, then remains stationary and finally drops rapidly before parturition.

The maternal placenta develops along

with the foetus, reaching its maximum weight towards the 16th day of pregnancy. The foetal placenta is visible about the tenth day and becomes larger until birth (Figure 12).

Embryo losses, measured by comparing the numbers of corpus luteum and living embryos, are usually very extensive. Generally speaking only 60 to 70 percent of the eggs become live rabbits. Most embryo mortalities occur in the 15 days before birth. Mortality is partly due to the viability of the embryos and partly to their situation in the uterine horns. External factors also play a part: the season and the physiological condition of the doe (especially her age). For a

FIGURE 10

Mating acceptance trends in gestating does

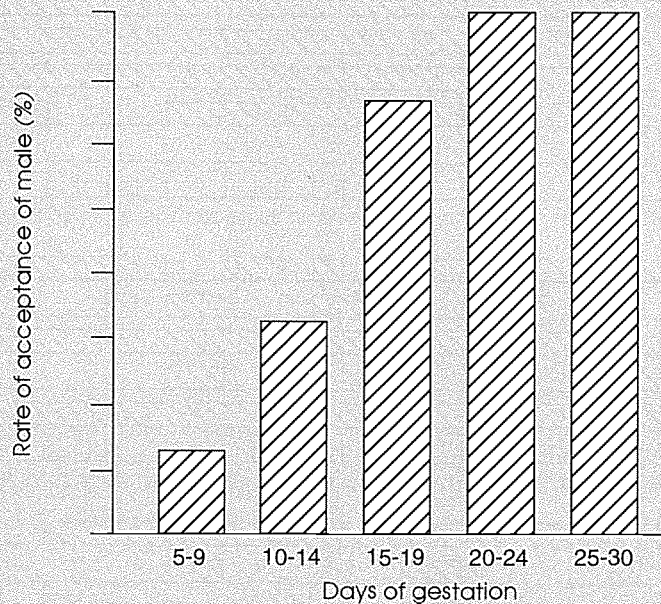

**Note:** Each column shows the total of acceptances for the five-day period. Does were not re-presented to the buck if they had accepted him.

*Source:* Moret, 1980.

simultaneously lactating and post-partum pregnant doe (fertile mating 24 hours after giving birth), late embryonic mortality is increased with respect to that observed in a simply pregnant doe under the same circumstances.

**Pseudopregnancy.** Liberated ova which are not fertilized may occasion a pseudopregnancy lasting 15 to 18 days. At first the corpus luteum and uterus develop as in an ordinary pregnancy, but they do not reach the size or the level of progesterone production of the corpus luteum in pregnancy. Towards the 12th day they regress and disappear under the action of a luteolytic factor secreted by the uterus, undoubtedly prostaglandin. The end of pseudopregnancy is marked by the maternal behaviour of the doe and nest-making, linked to the swift drop in blood progesterone. While such pseudopregnancy is much used in research laboratories on the physiology of reproduction, it is very uncommon in

natural-mating rabbitries. When a doe is serviced under unfavourable conditions she does not ovulate, and it is exceptional for ovulation to occur without fertilization (as in mating with a sterile but sexually active buck). Unfertilized ovulation can occur in 20 to 30 percent of artificially inseminated does injected with GnRH (see page 53). In this case, an injection of prostaglandin  $\text{PGF}_{2a}$  on the 10th or 11th day will halt the pseudopregnancy and the doe can be fertilized just 14 days after an earlier infertile insemination. Without prostaglandin treatment, the doe cannot be fertilized again until another week has gone by.

**Kindling.** The mechanism of parturition is not very well known. It seems that the secretion of corticosteroids by the suprarenals of the young plays a part, as in other animal species, in giving the signal for parturition.  $\text{PGF}_{2a}$  prostaglandins may also be instrumental in starting the process. At the end of gestation the doe makes a nest

FIGURE 11

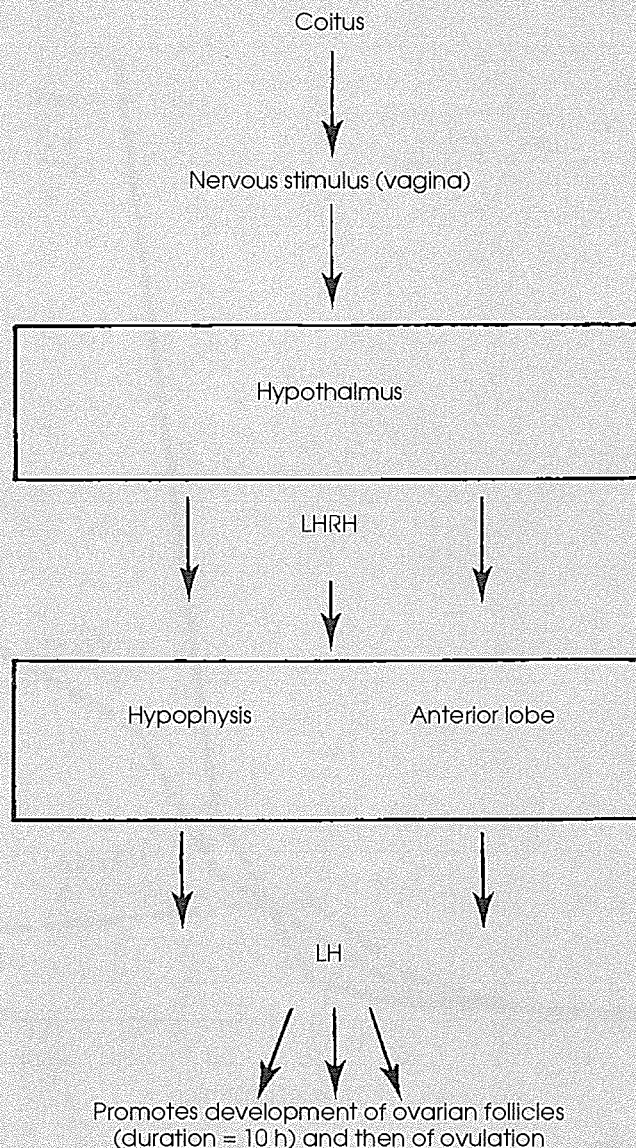
*Onset of ovulation following coitus*

Note: LH = luteinizing hormone; LHRH = LH releasing hormone.

for the litter with her own fur and materials she has available such as straw and shavings. This behaviour is linked with an increase in the oestrogen/progesterone ratio and with the secretion of prolactin. The doe does not always make a nest, or she may kindle outside the nesting box.

Kindling lasts from 15 to 30 minutes,

according to the size of the litter. Litter size varies as much as from one to 20 young. Most litters range between three and 12. In rabbit production units the average is seven to nine, but there are great variations.

After parturition the uterus retracts very quickly, losing more than half its weight in less than 48 hours.

FIGURE 12

Changing weights of foetus and embryonic membranes during gestation

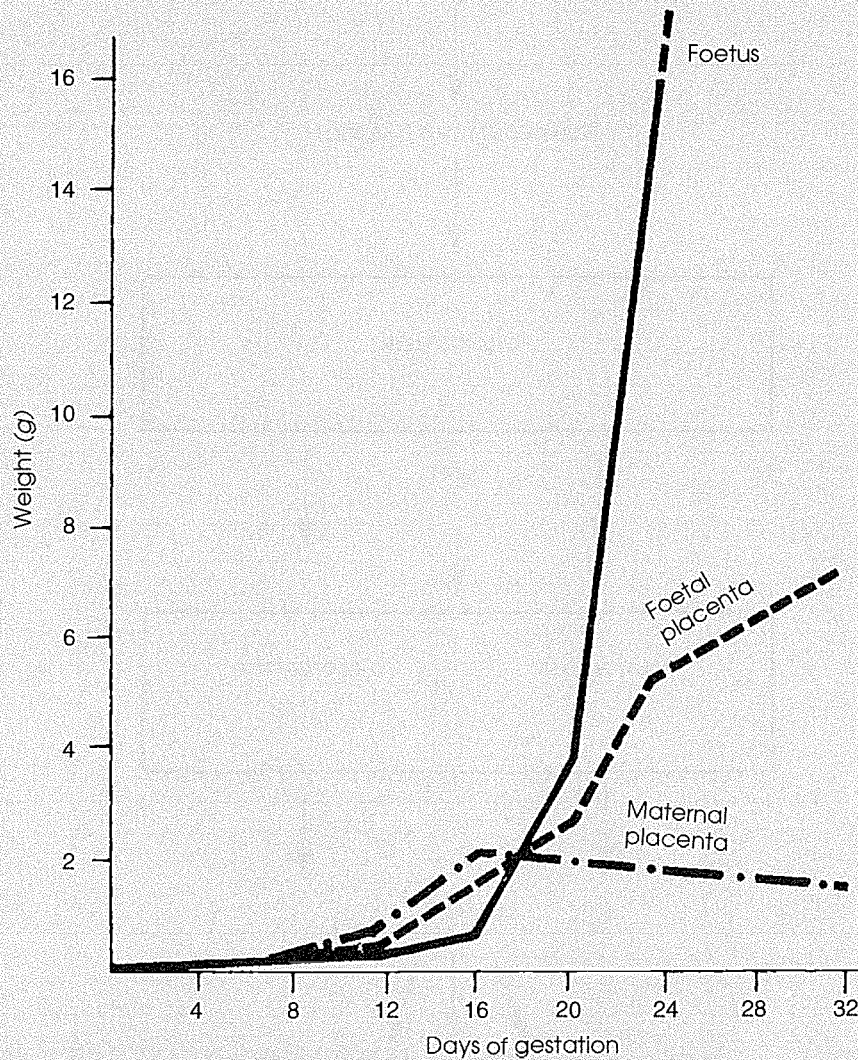

Source: Hammond and Marshall, 1925.

### Artificial insemination

Artificial insemination (AI) is a growing practice in European rabbitries, particularly in Italy and France. Currently, a little under 1 000 production units are involved, but the practice is growing primarily because of the opportunities for work organization involved: AI can impregnate a great many does on the same day without the need to maintain an excessive number of bucks. This paper, while not fully covering the topic of AI, will simply list the main advantages and drawbacks of the method.

**Semen collection and control.** A doe in heat is put into the buck's cage. The operator holds the artificial vagina with its collection tube between the rabbit's paws. The artificial vagina is kept at a temperature of about 40° to 42°C prior to use, so that it will be at 39°C, the normal vaginal temperature of a doe, at the moment of use. Ejaculation usually takes place immediately following the presentation of the doe.

A basic control of the biological quality of the semen is made for selection of the best ejaculates: no urine, sufficient motility

and concentration, etc. The semen is then diluted five to ten times, perhaps in physiological salt solution, within 30 minutes after semen collection, or, always the preferable choice, with a special diluent if it is to be applied within 12 hours. It is possible to freeze the semen, but the poor performance of frozen semen relegates this technique to research laboratory use where there is some interest in maintaining the semen of a specific buck for a long period.

The fact that a high percentage of the ejaculates has to be eliminated on the grounds of poor biological quality means that only a few males need to be retained for every 100 productive females, compared with natural mating.

It is clearly preferable to raise males on wire netting or grating than straw litter which considerably increases bacteriological contamination in the semen collected.

**Insemination.** The semen can be packaged in 0.5 ml pellets or presented in 20, 50 or 100 0.5 ml flacons for insertion with a glass cannula. Two techniques co-exist: an insemination gun covered with a single-use sheath, and the glass (or throwaway plastic) cannula. Both techniques have their partisans and their detractors and for both the diluted semen must be delicately inserted deep into the rabbit vagina.

As ovulation is not spontaneous in rabbits, intramuscular injection of an artificial analogue of GnRH (gonadoreline 20 µg, busereline 0.8 µg) is used to provoke ovulation at the moment of insemination. AI in rabbits involves a dual intervention: insemination and the injection of an ovulation-producing hormone.

**Successful artificial insemination.** Assuming that every operation involved in AI is strictly adhered to, practical success in this reproduction method is equivalent to that in natural mating for the same reproductive rate (percentage of gestation, litter size, etc.).

To ensure adherence, insemination centres are now springing up in Italy and France where male rabbits are maintained and their semen collected, controlled and packed by expert staff possessing the necessary techniques and resources. Like the bucks, these resources give full value for money as such centres can work every day of the week. The semen packaged ready for use is then shipped to specially equipped rabbit production units from the insemination centre. Once apprenticed, rabbit breeders can practise insemination themselves, which requires one or two operators, depending on the insemination technique chosen.

A number of breeders owning more than 30 to 40 breeding does do carry out all operations in their own establishment with good technical results. There have, however, been too many failures to suggest that a breeder should begin by practising every operation, from the preparation of artificial vaginas to insemination in the rabbit's genital tract, including the essential quality controls and disinfestation.

From the purely technical standpoint, does found not to be pregnant when palpated have ovulated after artificial insemination, thus developing a pseudopregnancy that made them temporarily infertile. It is therefore futile to reinseminate an empty doe less than 21 days after the preceding insemination, when the pseudopregnancy is over. In natural mating, however, a doe can successfully be represented to the male once it is realized she is not pregnant (10 to 12 days after mating). In this case the absence of pregnancy is almost always linked to an absence of ovulation, whereas after artificial insemination the absence of pregnancy is linked to early embryo mortality or the fact that the rabbit has not been fertilized. Treating pseudopregnant rabbits with prostaglandin may reduce the length of the infertile period and the rabbit can successfully be reinseminated after an unsuccessful AI, but

not enough is yet known about the specific modalities involved.

Overall, the highest fertilization rates with AI are obtained with receptive does, i.e. those which would have accepted natural mating. This is particularly true for lactating does and is why all (light, hormonal, etc.) treatments that increase doe receptivity also improve the performance of artificial insemination.

### Lactation

Milk synthesis depends on prolactin, a lactogenic hormone. During pregnancy prolactin is inhibited by the oestrogens and by progesterone. At parturition there is a rapid drop in the progesterone level. As oxytocin is freed the action of the prolactin is stimulated and permits the milk to mount in a predeveloped gland.

Milk is let down as follows: the doe comes into the nest box to nurse her litter. The stimulus of nursing provokes the secretion of oxytocin, inframammary pressure mounts, the milk is let down and the young suckle. The amount of oxytocin secreted is proportional to the number of young feeding. But the doe sets the number of feeds: just once in 24 hours. Suckling alone will not provoke the secretion of oxytocin; the mother must want to nurse.

*Aspects of milk production.* Doe's milk is much more concentrated than cow's milk except for the lactose component (see Table 27). After the third week of lactation the milk becomes markedly richer in proteins and especially fats (up to 20 to 22 percent). The already low lactose content tapers off to almost zero after the 30th day of lactation.

Daily milk production increases from 30 to 50 g in the first two days to 200 to 250 g towards the end of the third week of lactation. It then drops rapidly. The decrease is even swifter if the doe has been fertilized immediately after kindling (Figure 13). The lactation curve varies from doe to doe, es-

pecially with regard to duration. Measuring the young rabbits' weight at 21 days gives a fairly good estimate of total lactation, as milk production between days zero and 21 is closely correlated with total milk production ( $r + = 0.92$ ).

An important point is that the doe's milk output increases with litter size but the baby rabbits get less milk each than they would in a smaller litter. Depending on genetic type, milk production will not increase above eight to 12 baby rabbits.

## REPRODUCTION AND ENVIRONMENT

### Lighting

In males exposed to artificial lighting for only eight out of 24 hours significantly more spermatozoa are present in the gonads than in those exposed to light for 16 hours, although a slightly larger amount is usually collected in ejaculates from the latter.

Does, however, are far more opposed to mating with only eight hours of light than they are with 16. For both males and females 12 hours of light a day produce average results. The practice in rational European rabbit production units is to light breeding areas artificially for 15 to 16 hours a day. The males and females are together in the same room.

### Temperature

The impact of temperature on spermatogenesis has been studied by various authors, but usually for short periods ranging from just a few hours to a few weeks at most. In a prolonged five-week trial, Oloufa, Bogart and McKenzie (1951) noted actual falls in the volume and concentration of ejaculates at a high temperature (33°C). A high temperature also affects sperm motility even after such short periods of exposure as eight hours at 36°C, or medium periods such as 14 days at 30°C. Furthermore, and this seems to be the worst effect, temperatures in excess of 30°C reduce the bucks' sexual urge.

TABLE 27  
Average composition of cow's and rabbit's milk

Components	Rabbit's milk (days 4 to 21)	Cow's milk
	<i>Percentage</i>	
Dry matter	26.10-26.40	13
Proteins	13.20-13.70	3.50
Fats	9.20-9.70	4
Minerals	2.40-2.50	0.70
Lactose	0.86-0.87	5

Source: Lebas, 1971a.

However, these findings should not obscure the fact that rabbits do reproduce effectively in hot tropical or equatorial climates. Breeders should take the precaution of protecting their rabbits against extreme heat; they should avoid direct sunshine and protect the cages with an insulated roof, not just a corrugated metal sheet (which in fact transmits too much heat).

It should be noted that humidity does not seem to have been recorded in the various laboratory tests on the effects of temperature on spermatogenesis.

High temperatures also seem to affect female rabbits negatively. The lower prolificacy attributed to does reared in hot climates (30° to 31°C) would appear to be the result not so much of the temperature itself as a reduction in body weight caused by a lower feed intake in the heat (Figure 14). It would seem, however, that embryo mortality increases when the temperature exceeds 30° to 33°C, although here again decreased feed intake needs to be considered as a possible cause.

#### Season

In Europe the season is usually analysed in terms of the combined effects of light and temperature. In tropical climates the temperature effect seems to be dominant but an effect due to variations in the length of day-

light cannot be excluded. The reproduction cycles of the European wild rabbit are strongly influenced by the season. Does breed from the end of winter until early summer (Figure 15). The reproduction period can be longer or shorter, at either end, according to both temperature and availability of feed.

Exposing domestic does to light for 16 out of 24 hours in Europe considerably attenuates this seasonal variation; indeed it nearly suppresses it. Even so, reproduction problems sometimes appear at the end of summer with no direct relation to the temperature. In tropical climates a drop in the rate of reproduction is noted during the same period, the wet season, when temperatures are high and so is humidity.

#### RATES OF REPRODUCTION

The physiological features of the male and especially the female are such that the breeder has great latitude in choosing a reproduction method. But for successful rabbit production the choice of method must be preceded by careful study and planning. The goal is to increase doe productivity and reduce inputs.

Productivity, defined as the number of young per doe per unit of time, depends on: the interval between successive kindlings; litter size at birth; and the survival rate of the young.

FIGURE 13

Pattern of milk production in does

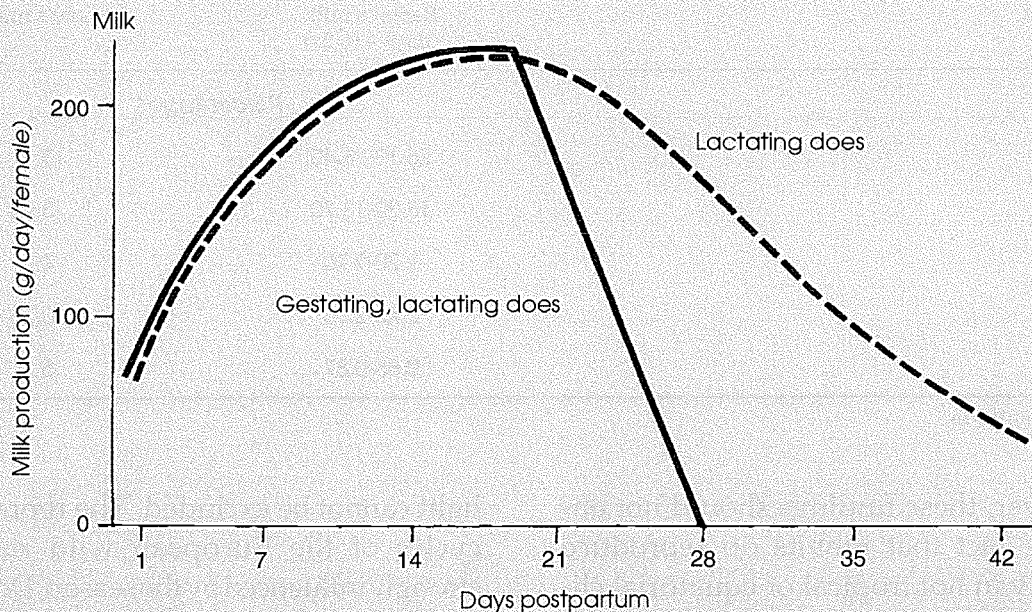

Source: Lebas, 1972.

These criteria can be improved by slow, methodical selection and careful management of the rabbitry environment. In practice the crucial factor in increasing productivity is shortening the kindling-to-mating interval. This means non-productive periods must be reduced to the minimum. Before such a strategy is adopted the breeder should consider:

- whether or not it will be exhausting for the does, perhaps leading to premature culling (this depends mainly on feeding conditions);
- whether or not it might cause a spontaneous reduction in doe fertility and prolificacy;
- whether it will lead to more work for the breeder.

The breeder's desire to improve working conditions and reduce labour costs must also be considered. The final objective criteria for selection must be the production of good rabbits for sale or for consumption per unit of time or per production unit labour cost per hour.

#### Age at first mating

Before discussing the rate of reproduction, the first factor to consider is the age at first mating. Shortening the unproductive period before the first litter would automatically increase productivity. Studies conducted in France on does receiving a balanced concentrated feed showed that female rabbits first serviced at five and a half months had lower annual productivity than females serviced three weeks earlier. The first group had virtually reached their adult weight and were too fat. The best plan is to have does serviced as soon as they reach 80 (or, at the most, 85) percent of the mature weight for their breed. Females can be serviced even earlier if their feed is extremely well balanced (see earlier section on female rabbit physiology).

#### The three basic reproduction rates

The second method of stepping up production, after earlier servicing, is to accelerate the rate of reproduction. This amounts to shortening the theoretical interval between



FIGURE 14

Changing live weights of young does aged from 37 to 112 days reared in different temperatures

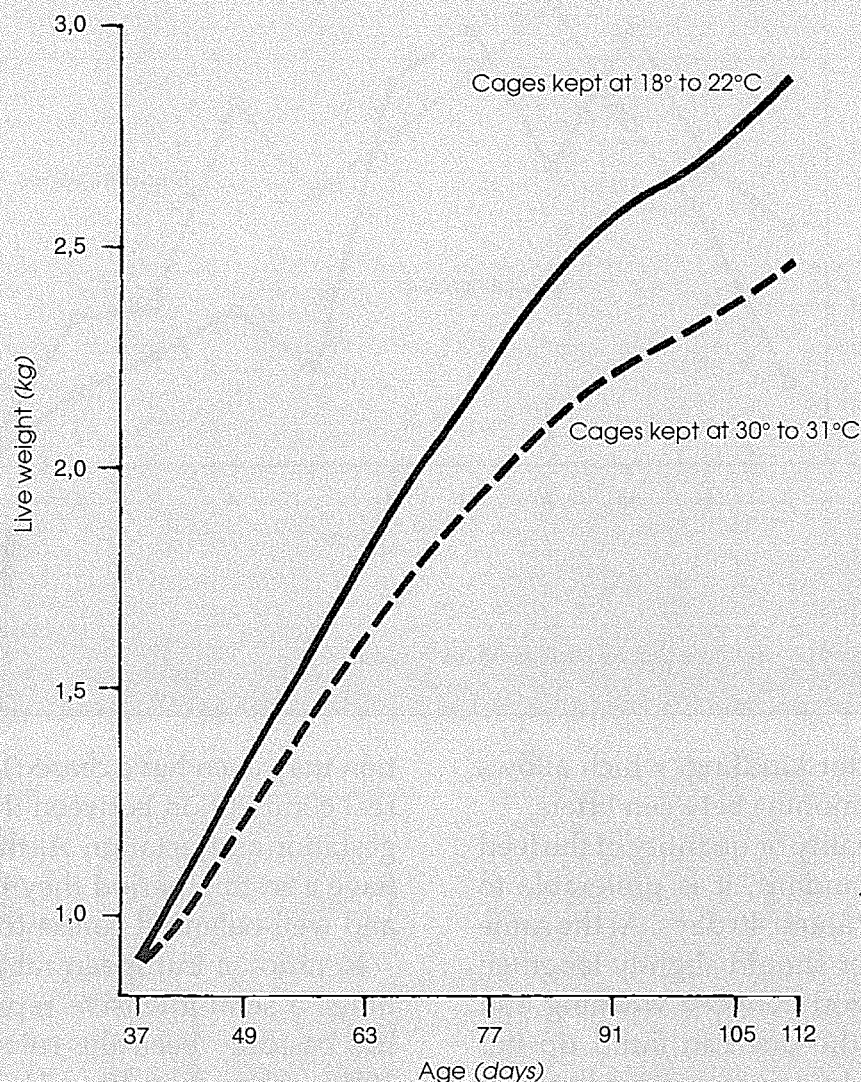

two successive litters. In fact, the true rate of reproduction is always slower than the theoretical rate because not all does immediately accept the buck and not all are fertilized when rebred. There are three basic rates of reproduction: extensive, semi-intensive and intensive, but all intervening stages are or have been used; the distinction is retained here for illustrative purposes.

**Extensive reproduction rate.** The breeder fully utilizes the does' maternal instincts

by allowing them to nurse their young for five to six weeks, rebreeding them soon after weaning. Does are therefore serviced once every two and a half months.

Later weaning is in no way advantageous except for fryer production – very young animals which can be sold at eight weeks and have not undergone weaning shock. In the United States and the United Kingdom fryers with a live weight of 1.7 to 1.8 kg are produced this way, using breeds such as the New Zealand White. The mother can be serviced before weaning, about five

FIGURE 15

Seasonal variation in percentage of gestating and/or lactating wild does in the United Kingdom

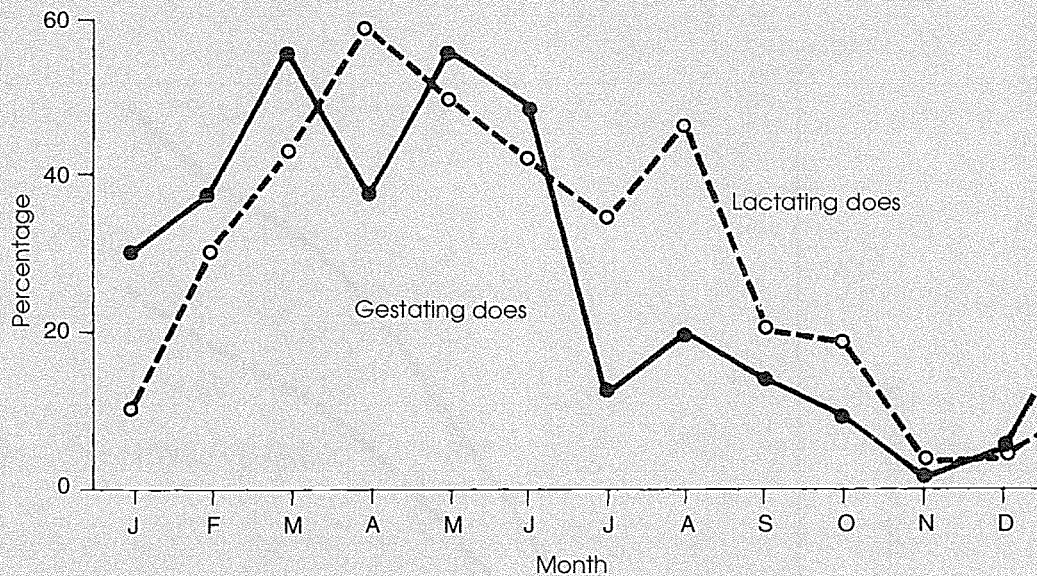

Note: Figures are based on wild does shot for each month of the year.  
Source: Stephen, 1952.

or six weeks after kindling, which allows two and a half months between litters.

Where the quality or quantity of the feed is not up to standard, it is preferable to wean rabbits at about 40 days. At the same time the breeder should slightly lengthen the resting period between weaning and rebreeding so the doe can build up her reserves again. In any case, weaning later than six weeks offers no particular nutritional advantage. The milk produced by the doe after this period provides at most 3 to 5 percent of the young rabbits' daily feed intake.

**Semi-intensive rate.** The breeder has does serviced 10 to 20 days after kindling and the young are weaned at four to five weeks. There is no real contrast between pregnancy and lactation for does. For 10 to 20 days the doe is newly pregnant while still nursing. The most important phase of embryo development takes place during the slump in milk production (milk produc-

tion may even have ceased), so there is no real competition between the demands of gestation and lactation. As these does never have a resting period they need sufficient and well-balanced concentrate feed.

In rational European rabbit production units, a semi-intensive reproduction rate has basically been the rule since the late 1980s: rebreeding 10 to 11 days after kindling; weaning at about 34 to 38 days. At this rate, the work can be programmed by the days of the week, as the plan involves an interval of 42 days (exactly six weeks) between matings: 30 to 31 days of pregnancy + 10 to 11 days following kindling.

**Intensive rate.** The breeder has the does reserviced just after kindling, taking advantage of the fact that they are then on heat. Weaning should take place at four weeks at the latest, usually at 26 to 28 days. There are three main techniques:

- servicing the same day or the day after kindling: the true postpartum rate;

- servicing scheduled for a specific day, generally three or four days after kindling. This corresponds to a constant interval of 35 days (five weeks) between litters; the results of this 35-day rate are economically disappointing because the rate of female acceptance of servicing three or four days after kindling is very low in most rabbit production units, although not all;
- ad lib mating. A buck left together with postpartum does will serve them several times during the 48 hours following kindling. This is the natural rhythm of wild rabbits.

To arrange ad lib mating, breeders have worked out two types of rabbit housing. The first is the corridor-collar type: the does live in individual cages. They have a broad collar around their necks to prevent them from leaving the cage through the calibrated opening leading into a communicating corridor. The buck, however, has free access (at least temporarily) to the does' cages and can mate whenever the doe is ready.

The second is the group system: a buck and perhaps ten does live together in the same cage. They can mate at the optimum times. However, special arrangements must be made to curb the natural tendency of females to kill the offspring of other does when they themselves are lactating or ready to kindle.

#### Choosing the reproduction rate

Considering the greater nutritional needs of the pregnant doe, especially one which is also lactating, semi-intensive and, especially, intensive reproduction systems are only suitable where does get the right quantity and quality of feed. If these conditions are not met, the does will usually accept the male but later abort.

Abortion extends the interval between litters to match the extensive breeding interval. Figure 16 shows the main periods in the reproduction cycle and how under in-

tensive reproduction the doe has no opportunity to build up reserves.

Numerous comparisons of intensive, semi-intensive and extensive reproduction have been made, principally in France. Twenty years ago the litters of does mated postpartum numbered one less than those of does remated ten or more days after kindling. This is virtually no longer true, mainly because of improved feeding and the selection of strains and lines suitable for intensive reproduction. The systematic use of the most intensive reproduction method, however, makes it difficult to keep female brood stock in good condition, particularly primiparous females. This means a more rapid turnover of stock and the risk of an unfavourable subclinical disease situation, making does more sensitive to any agent of disease or environmental perturbation. After extensive experimentation from 1970 to 1985, European breeders have in fact almost all abandoned the systematic use of postpartum servicing.

In many cases, breeders adopt a variable rate of reproduction, depending on the condition of the does. For instance, a good healthy doe which produces a litter of fewer than seven or eight is immediately remated. If she has given birth to ten or so young the breeder waits about 12 days before having her serviced. In autumn, when it is harder to get the rabbits to mate, breeders systematically take the does for servicing after parturition. This is to take advantage of the strong postpartum oestrus during which 95 to 99 percent accept servicing. Even so, breeders avoid postpartum remating of primiparous does. As has already been mentioned, breeders are increasingly adopting a semi-intensive 42-day rate organized on a weekly basis, as will be discussed in the chapter on rabbit management.

With careful use of a semi-intensive rate, a good breed and balanced feed, European breeders are obtaining 55 to 65 weaned

FIGURE 16

Distribution (as percentage of productive life) of gestation, lactation and resting periods in does used at different rates of reproduction

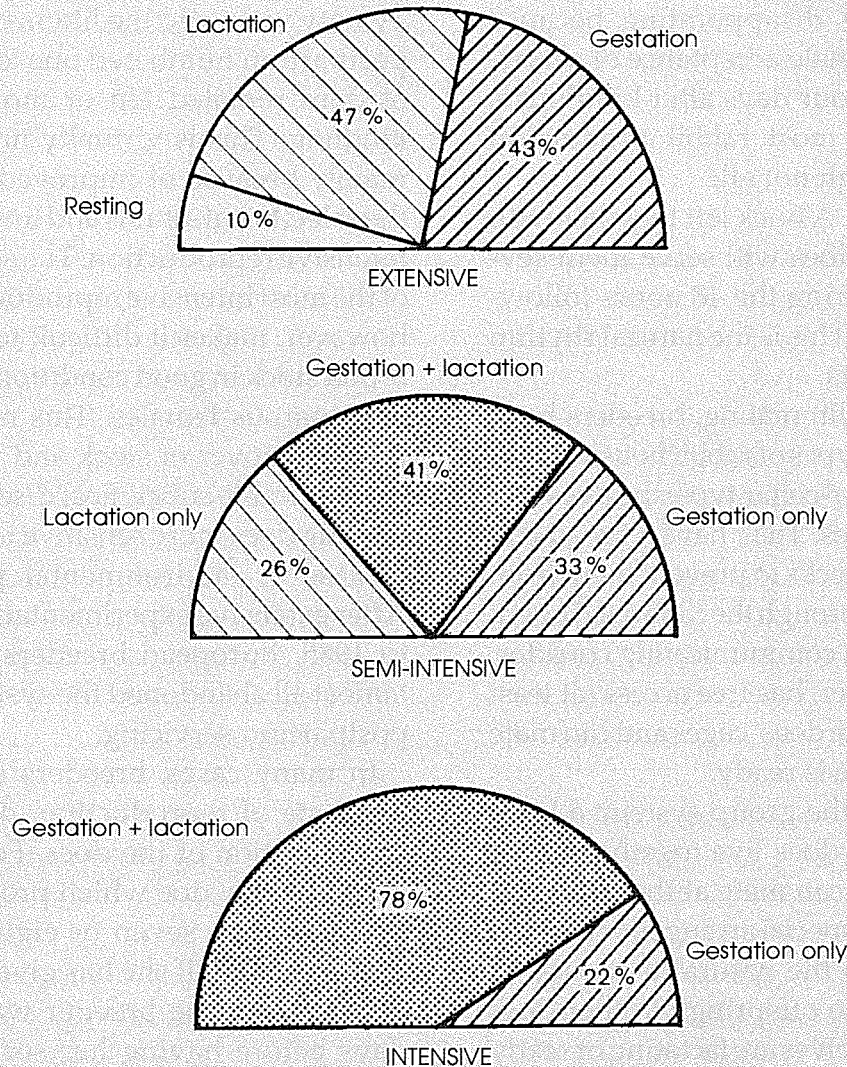

young annually per doe. In the tropics under identical production conditions of rate, breed and feeding, the number of young produced per doe is about 30 to 40.

Using the extensive rate the best breed-

ers obtain 30 to 35 weaned young per doe per year. In a tropical climate, depending on the region and especially on feeding, 15 to 30 weaned young can be produced under extensive reproduction.

## Chapter 4

# Genetics and selection

### INTRODUCTION

Domestic rabbits are the descendants of *Oryctolagus cuniculus*, a species native to the western Mediterranean basin (Spain and North Africa). Wild rabbits belong to other genera: *Sylvilagus*, *Coprolagus*, *Nesolagus* and *Brachylagus*. The rabbit was domesticated relatively recently: most breeds are created by humans and are no older than 200 or 300 years, which is why there are few locally adapted land races.

The rabbit has been used as an experimental animal in genetics and reproduction physiology since the beginning of the century, but it was not until 1950 that the first findings on quantitative genetics were published, in Venge's study of maternal influence on rabbit birth weight (Venge, 1950). This work paved the way for research on the genetic improvement of the rabbit for meat production. Scientists at the National Institute for Agricultural Research (INRA) in France initiated research and development in this area in 1961, followed by work in other research laboratories in many countries, such as that of the teams of the University of Zagazig in Egypt, of Gödöllő and Kaposvar in Hungary, of Iztnanagar in India, of Milan and Viterbo in Italy, of Valencia, Saragossa and Barcelona in Spain, the Normal team in the United States and the Chinese teams (particularly in Shanghai) and those working in Nitra in Slovakia and in Cracow in Poland. Robinson's excellent 1958 bibliography in *Genetic studies of the rabbit*, based on sound genetic and physiological data, is now outdated by this new research.

Work on rabbit genetics has been regularly updated at world rabbit congresses

(Rouvier, 1980; Matheron and Poujardieu, 1984; Rochambeau, 1988). However, experience gained under European production conditions cannot be transferred directly to developing countries. To upgrade their rabbits, breeders should use local animals, either native or from imported populations that have been locally adapted, and make use of the genetic variability that is available.

It does seem that priority should be given to research on rural and backyard rabbit production. These would be small, thrifty, autonomous units requiring little investment and using local resources. They would be reasonably productive.

### GENETICS OF RABBIT BREEDS AND POPULATIONS

Perhaps the best of the various definitions of *breed* is Quittet's: "A breed is a collection of individuals within a species which share a certain number of morphological and physiological characters which are passed on to their progeny as long as they breed among themselves."

One way of assessing the genetic uniqueness of different breeds is to study their origins. A breed is the outcome of the combined impact of artificial and natural selection (environmental adaptation). It is difficult to define exactly what is a breed and what is its background. Artificial selection may be based on a number of different criteria, not necessarily all to do with productivity. The breeding conditions may be either artificial or natural, the environment may gradually change and so on.

Rabbit breeds or populations can also be defined in terms of gene frequencies.

This is possible with genes identifiable through their visible or major effects on progeny. Coloration and hair structure are classified as visible effects. Thanks to advanced observation techniques the genes governing blood groups, biochemical and protein polymorphism and hereditary anomalies are now also known. (See Zaragoza *et al.*, 1990.)

For quantitative characters, such as litter size or weight at weaning, which are controlled by a great many non-identifiable genes, rabbit populations can also be defined by their performance. These genes are also assumed to have little effect on overall variability and to function independently, according to the standard assumptions of quantitative genetics. Such characters are also influenced by the environment. The environmental characteristics must be carefully described (number of breeders, the direction of selection, the origin of the population and its range) when describing a population.

The genes are carried by chromosomes organized into 22 pairs ( $2n=44$ ). About 60 markers have been described. These are genes of visible effect such as colour or coat or morphological anomalies, or genes coding for molecules of which the biological impact is being studied. These two approaches are hard to reconcile, for teams often use only one type of marker. Among the markers described, 37 have been placed on eight autosomes and on chromosome X; 23 markers constitute six linkage groups, and the locus of six markers has still not been found. All these markers are spread over a majority of 22 pairs of rabbit chromosomes. The links between the biological markers and the genes for colour or hair have rarely been tested, however.

Experience has shown that the rabbit can support a slow and gradual increase in inbreeding, but research suggests that mating programmes for small populations should minimize its extent and rate of

increase among the stock (Rochambeau, 1990).

Breeds created by selectors, particularly amateurs in the United States and Europe, now conform to official standards. The book of the *Fédération française de cuniculture* (FFC) on standards for rabbits describes more than 40 breeds. Each has been bred from animals of local and regional populations, or by crossing existing breeds, or by using mutants for changes in coat colour or structure. Mass selection for size and body morphology has separated these breeds into giant, medium, small and very small. It is interesting to study the origin of the breeds to learn whether they may correspond to original genetic ensembles and to attempt to determine their characteristics.

The characters by which an animal conforms to a breeding standard, such as body size, whether or not it is compact, coat colour and density and ear size, may be related to its resistance to variations in climate. In fact, such factors as coat, skin, body area and weight affect the animals' body temperature.

The currently known genetic determinants of variations in colour and structure are listed below. Coat colour has always been of great interest to breeders.

#### Coat colour and hair structure

In *The genetics of domestic rabbits*, published in 1930, Castle described six mutations in coat colour and two mutations in patterns; three mutations in hair structure; one mutation in the yellow colouring of the abdominal fat and two linkage groups. A convenient way to detect the effects of various mutations is to describe the rabbit's "wild" colouring. The coat consists of three types of hair: the longer, rectrix guard hairs, stiff at the base; the more numerous tectrix barbed hairs forming the major part of the coat, which share a hair follicle with the third type – the shorter hairs making up the undercoat.

The coat colour of the wild or "agouti" rabbit consists of grey dorsal fur with a much lighter or white ventral area. The long guard hairs are black but appear deeper black at the tips and bluer at the base. The barbed hairs have zones of colour: black at the tips, with a yellow band in the middle and bluish at the base. The fibres of the underfur are bluish at the base and fringed with yellow at the tips. Colouring is thus basically due to the distribution of black and yellow pigments (eumelanin and pheomelanin) in the hair, especially in the barbed hairs, and over the whole coat (sides and back in relation to belly fur). Mutations in different loci modify this colouring.

**Colouring.** There follows a list of the international notation of alleles. Arnold (1984) shows the correspondence with the German system.

- Locus *A*, agouti: the non-agouti mutation *a* produces animals without a yellow band in the hair and a lighter belly. Their colouring is uniform. *A* is dominant over *a*. A third allele has been described at this locus, *a'* (tan pattern), which is recessive to *A* and dominant over *a*.
- Locus *B*, black pigment: a recessive *b* allele produces a chocolate brown pigment instead of black in agouti hair.
- Locus *C*: the *C* gene is required for the development of pigments in the fur, skin and eyes and hence for the expression of colouring. The recessive *c* gene inhibits the expression of colouring, causing albinism in recessive *cc* homozygotes. There are several alleles at this locus, quoted below in dominant-to-recessive order:
  - C*: full expression of colouring.
  - c<sup>ch</sup>*: chinchilla, suppression of colour in the intermediate band of the coat.
  - c<sup>h</sup>*: Himalayan. Only the hairs at the body extremities are black. The expression of this gene depends on the ambient temperature.

*c*: albinism. The albinism locus is epistatic over the colour loci. The *cc* genotype covers the expression of colour genes situated at other loci.

- Dilution, *D*, *d*: the recessive mutant *d* allele affects the intensity of the pigmentation, causing a dilution of the pigment granules. The dominant *D* allele produces normal pigmentation density. The recessive *dd* homozygote is found in the genotypes of blue (black diluted to blue) or beige (yellow diluted to beige) rabbits.
- Normal extension of black *E* or yellow *e*: the *e* gene mutation causes increased yellow pigment in the hair, tending to replace the black (or brown) pigment. Grey, black or brown breeds have the *E* gene. Yellow and red breeds are recessive *ee* homozygotes.
- Vienna White locus: Vienna White rabbits have completely unpigmented fur but coloured eyes (blue). The original gene is called *V* and its mutated form *v*. Rabbits of the Vienna White breed are therefore recessive *vv* homozygotes. Crosses of this breed with albino rabbits produce coloured progeny.
- Mutations producing a mottled coat: these mutations involve the loci for English (*En*, *en*) and Dutch (*Du*, *du*). The Papillon rabbit is of the *En en* heterozygous genotype. The *En* gene is incompletely dominant. The *En En* homozygotes are whiter than the heterozygotes, while recessive homozygotes are blacker. The colour genotype of the Papillon rabbit (Giant Checker in English, Mariposa in Spanish) cannot be pinpointed. At the other locus the *du du* genotype produces the white belt characteristic of the Dutch rabbit.

**Hair structure mutations.** The three main ones are:

- Angora. This is a recessive autosomal mutation expressed as a lengthening of

the duration of hair growth at the same speed of growth which produces longer hair. The wild ( $L$  dominant) gene has mutated into a recessive  $l$  allele to produce the Angora. The mating of two Angora rabbits always produces Angora offspring. Two rabbits with normal hair can sometimes produce a fraction of Angora progeny if they are  $Ll$  heterozygotes.

- **Rex.** This is a recessive autosomal mutation that causes almost all of the guard hair to disappear. The coat looks different with shorter hair. The symbol for the Rex gene is  $r$ , and for the dominant wild allele  $R$ .
- **Hairlessness.** This is caused by several recessive mutations and is usually lethal.

The genotype of the coat colour and structure in rabbit breeds can be predicted when these loci are known. So far not much gene interaction visibly affecting body colour and breeding characters has been found, but there has been very little research in this area. The Angora and Rex genes are of course exploited to produce Angora wool and Rex fur.

#### Groups of breeds by adult size and origin

There are different kinds of breeds:

- primitive or primary, and geographic, from which all other breeds have come;
- breeds obtained through artificial selection from the above, such as Fauve de Bourgogne, New Zealand White and Red and Argenté de Champagne;
- synthetic breeds obtained by planned crosses of several breeds, such as Blanc du Bouscat and Californian;
- Mendelian breeds, obtained by the fixation of a new character of simple genetic determination, appear by mutation, such as Castorrex, Satin and Japanese.

Breeds are conveniently grouped by adult size, which is also related to production

characteristics such as precocity, prolificacy, growth rate and age at maturity. A major determinant of adult size is the origin of the breed.

**Heavy breeds.** Adult weight exceeds 5 kg. Fertility is generally low. The growth potential of the heavy breeds can be exploited, especially in cross-breeding. The Bouscat Giant White, (French) Belier, Flemish Giant and French Giant Papillon are examples. The fur of the (French) Belier varies greatly in colour and can be white, agouti, iron grey or black. Its body build would make it a good meat rabbit. However, it is bred for show and therefore found only in small units, at least in France. The breed is more important in other European countries such as Germany and Denmark.

The Bouscat Giant White is a synthetic albino breed. It is a large rabbit known for its prolificacy and fast growth rate in traditional French rabbitries. The Flemish Giant from Belgium comes in several colours. It is one of the largest rabbits (potential adult weight 7 kg) and is still farm-raised. This breed could furnish a gene pool for improving growth in other breeds; Flemish Giants could be pure-bred for this purpose.

**Average breeds.** Adult weight varies from 3.5 to 4.5 kg. These are the basic stock of breeds used for intensive rabbit production for meat in western Europe and are the most numerous. Only a few examples are described here.

Silver rabbits are found in several countries (English Silver, German Silver). These varieties differ from the Argenté de Champagne in adult size (English Silver is lighter) and colour. Like Fauve de Bourgogne, Argenté de Champagne is an example of a breed that has developed with selection over many years from a regional population (Champagne). The breed is known for both its fur, once much sought after, and its productivity: high fertility, quick growth,



good muscle development and good meat quality. Its adult weight is 4 to 4.5 kg. It is farm-bred in France, usually on straw litter. Research has begun on intensive breeding of Argenté de Champagne.

The Fauve de Bourgogne is also of regional origin. It has spread throughout France and elsewhere in Europe (Italy, Belgium, Switzerland). The Fauve de Bourgogne Rabbit Breeders' Association has established a stud book for this breed, ensuring pure-bred selection.

The New Zealand Red was first exploited in California with a selection system similar to that used in France on the Fauve de Bourgogne, with the difference that the New Zealand breed was raised on wire-mesh floors which were introduced much earlier in the United States than in France.

The Californian is a synthetic American breed. It was presented for the first time in 1928 in California by its breeder, whose objective was a meat animal with very good fur. The adult weight of the Californian is 3.6 to 4 kg.

The New Zealand White originated as a breed in the United States. It is the albino offspring of coloured rabbits. From the outset it was bred selectively in large meat-production units, especially in southern California (San Diego area), for its breeding qualities: prolificacy, maternal performance, fast growth rate and precocious body development which makes it ready for slaughter at 56 days, the objective being a light carcass. The New Zealand White adult weight (4 kg) slightly exceeds that of the Californian. The New Zealand White was used in the first studies on the rabbit at the Fontana Station in California. Since 1960 this breed has spread through Western Europe and other regions with the growing use of mesh floors for rabbit cages.

The Large Chinchilla rabbit raised in Europe is of German origin. Its adult weight averages 4.5 kg. It can be bred for meat and fur.

**Lightweight breeds.** These breeds have an adult weight of 2.5 to 3 kg. They include the Small Himalayan, the Small Chinchilla, the Dutch and the French Havana.

The Russian or Himalayan rabbit is white with black extremities. It is thought to have originated in China and spread from there to Russia and Poland. It carries the Himalayan  $C^h$  gene mutation.

The lightweight breeds usually develop very quickly and make excellent mothers. They eat less than the medium and large breeds and could be crossed or used pure in developing countries to produce a light, meaty carcass of 1 to 1.2 kg.

**Small breeds.** These breeds weigh about 1 kg at maturity. They are represented chiefly by the Polish rabbit, with its many variations of coat colour. Selection for small size has led to very low fertility and a marked decrease in growth rate. These breeds cannot be used for meat production. They are bred for show, for the laboratory and as pets.

#### Local populations and strains

Pure-bred animals are usually raised in small groups and their selection for breeding characters is in its infancy. These breeds could therefore constitute interesting potential gene pools for improving local populations.

Most rabbits raised for commercial meat production belong to populations which may resemble one breed or another (a question of appearance only, as they do not meet the criteria for that particular breed in terms of origin and standards) and sometimes resemble no breed at all. These are "common" rabbits, grey, spotted or white, the outcome of various unplanned crosses. They may belong to local populations. Some examples of local populations in developing countries are the Baladi rabbit of the Sudan (*baladi* means native or local in Arabic), the Maltese rabbit of Tunisia and the

Creole rabbit of Guadeloupe. Developing countries planning to develop rabbit production should first identify existing local populations and establish their biological and breeding traits and adaptability before designing selection programmes and improved production systems.

Many countries where rabbit production is recent, dating back only a few decades, have no clearly defined local populations. The populations are highly polymorphic and come from a great many unplanned crosses with imported pure-bred animals. Often these populations are of limited potential and not locally adapted. Even so, they should be studied before deciding to eliminate them.

Finally, there are rabbit strains. The strain is a genetically closed group, small in number, with no outbreeding for several generations. Characteristics of a strain are the number of breeding animals, the year and way the group was constituted, and possibly the mating programme (selection or no selection). These strains can be found in research laboratories which keep them to study their biological and breeding characteristics in order to make the best use of them in selection. The INRA centre in Toulouse conducts selection experiments on strains (Table 28).

Private breeders have fairly recently begun selecting rabbit strains, along the lines of the poultry selection that has been practised since 1930. But some breeders or small groups of breeders, at village level for instance, may also have created strains without realizing it.

Some research laboratories, such as the Jackson Laboratory at Bar Harbor, Maine, United States, keep inbred rabbit strains or lines for use solely as laboratory animals.

Breeders in traditional rabbit-breeding regions use local populations. The genetic patrimony of the population is shaped by the ecology of the region, the characteristic production system and breeders' interven-

tions. Slowly, the population evolves. Barring specific instances, the population is open to bordering populations. This slows the trend towards uniformity and offers new genetic variability for natural and/or artificial selection.

The next stage of evolution is the breed. Here the breeder is more important and defines a standard and looks for animals which conform to it. The ecology of the region and the characteristic production system is less influential than for populations and breeds are usually more homogenous. Selection for confirmation to a standard can lead to excesses. Breeders may be looking only for external characters, neglecting production characters. They may breed close relatives to increase the visual impression of homogeneity. The last evolutionary stage is the strain. There are fewer founders (a few dozen for each sex) and few genes are exchanged with neighbouring populations. A strain is usually artificially selected for a few traits. Strains are often more genetically homogenous than breeds.

#### Breeding characters

The expression of breeding characters depends on environment and the breeder. A comparison of results from several different environments and geographical locations can reveal general characteristics of the breeds or species. Fecundity, growth rate and tissue development in young rabbits are three sets of basic breeding characters.

**Fecundity.** Fecundity is defined as the product of fertility (number of kindlings per doe per unit of time) and prolificacy (number of young per kindling).

Prolificacy varies significantly according to several factors which may be inherent in the animal. Litter size increases by 10 to 20 percent from the first to the second litter and then again, but by less, from the

TABLE 28  
 Characteristics of selected INRA experimental strains

Strain and origin	Selection criteria	Selection methods	Population size	No. of generations
1077 New Zealand White	Litter size at weaning	Index	33 males 121 females	18
9077 Same origin as 1077	Field strain		22 males 44 females	12
2066 Californian and Large Himalayan	Litter size at birth	Index	24 males 64 females	18

second to the third, with no change from the third to the fourth. After the fourth the size may decrease. Inbreeding may reduce prolificacy.

Prolificacy also depends on the season and the reproductive rate imposed on the doe. In healthy does receiving normal feed and 12 to 14 hours of light, prolificacy seems to be linked to adult size.

Ovulation potential increases, on average, with size. The first factor affecting prolificacy is the ovulation rate (number of eggs) followed by the viability of blastocysts and embryos before birth.

In 1932, Gregory showed that litter size depends on the number of eggs produced after mating and this number depends on the body size of the breed: 3.97 for Polish does and 12.88 for Flemish Giant. The corresponding litter sizes at birth are 3.24 and 10.17. Small light breeds are generally less prolific than medium and large breeds. Elamin (1978) gives the following average figures from the Sudan for the Baladi, Californian and New Zealand White breeds:

	Baladi	Californian	New Zealand White
Total litter size	4.7	7.10	7.49
Live births per litter	3.5	6.67	6.94

Matheron and Dolet (1986) analyse the results from 682 females in ten rabbitries in Guadeloupe. Their first category is small-size Creole females. These are hard to find and so breeders buy them in France and cross-breed them many times. They then distinguish between New Zealand White and "other" females on which more specific data are lacking. In these complex crosses, breeders have used Argenté de Champagne, Fauve de Bourgogne, Bouscat White, Papillon, etc. in addition to the above two strains. Table 29 shows that New Zealand females are more fertile and more prolific. This is a confirmation of the high adaptability of this breed to local conditions of high temperatures and humidity. Birth-to-weaning mortality is still high, indicating a need for further progress. Creole females are less prolific but more viable than the "other" females. The difference of -0.78 at birth is only -0.12 at weaning. The poor birth-to-weaning viability of young from "other" females is surprising. The literature indicates that these half-breed females often benefit from the effect of heterosis and complementarity, but the performance here shows that this is not always the case. It is also possible that the choice of breeds and crosses was poor.

Paez Campos *et al.* (1980) give the breeding parameters of New Zealand White, Californian, Chinchilla and Rex breeds raised at the National Rabbit Breeding

TABLE 29  
Performance of females of three genetic types in Guadeloupe rabbitries

Litter size	Breeds				Mortality (%)			
	Number	Pregnancy rate (%)	Total births	Total live births	Weaned	Birth	Birth-to-weaning	Total
Others	2 159	75	7.33	6.72	4.54	8	32	38
Creole	78	71	6.55	6.21	4.42	5	29	32
New Zealand White	291	80	7.44	6.71	5.14	10	23	31
Total	2 528	76	7.32	6.70	4.60	8	31	37
Significance of the breed effect		**	NS	NS	*	NS	**	**
Standard deviation			2.78	2.86	3.00			

Source: Matheron and Dolet, 1986.

TABLE 30  
Average breeding parameters of four breeds raised at the Irapuato National Rabbit Breeding Centre, Mexico

Strains	Litter size	Live births per litter	Rabbits weaned per litter	Age at first mating (days)	Weight at first mating (kg)	Number of litters examined	Number of does
New Zealand	8.5	8.0	6.5	144	3.49	3 723	600
Californian	8.0	7.2	5.8	140	3.50	1 090	200
Chinchilla	8.7	8.1	6.0	132	3.39	562	140
Rex	6.8	6.3	5.1	153	3.02	554	120

TABLE 31  
Litter size observations in Cuba for four rabbit breeds

	Total births per litter	Total live births per litter
Semi-giant White	9.3	8.2
Californian	7.8	6.6
New Zealand White	7.0	6.2
Chinchilla	7.6	6.4

Source: Ponce de Léon, 1977.

Centre at Irapuato in Mexico, a tropical zone tempered by the 1 800 m altitude (Table 30).

Ponce de Léon (1977) obtained the results in Table 31 from four breeds researched in Cuba, in a wet tropical climate. The charac-

ters of these breeds and this rabbitry are defined in greater detail further on in the chapter. The high rate of stillbirths (11.6 percent) is explained by rearing conditions in the rabbitry.

The development of technical and economic management systems in France and Spain provides series of results describing performance trends in rabbit production units. For the sample regularly followed in France by the *Institut technique de l'aviculture*, litter size (number of live births) rose from 7.2 in 1974 to 7.8 in 1986, reaching 8.6 in 1992.

Table 32 summarizes other findings comparing breeds reared under rural or southern country conditions. The numerous European and United States comparisons of medium-sized breeds such as New Zealand White and Californian rabbits, for which Rochambeau's (1988) summary might be consulted, have been deliberately omitted. The table stresses the importance of studies in India and Egypt. Regrettably, there are few studies on local populations. The New Zealand White and Californian rabbits are used by many authors, but they are very different strains. Since most authors rarely specify the origin of their animals, it is difficult to compare them and these various populations of white rabbits may well have only the phenotype of colouring in common. This table also shows the importance of specific "giant" populations found in India and Egypt, but without knowing the adult size of these populations it is impossible to know whether they really belong to giant breeds. Other populations such as the Russian Chinchilla or the Sandy also deserve attention.

**Biological components of prolificacy.** The description of biological traits in local populations and breeds provides useful pointers for better utilization strategies. The procedure is to count the numbers of corpus luteum to estimate the rate of ovulation. The number of implantation sites and the number of living and dead embryos are then counted to determine embryo viability. Litter size at birth completes the estimation of foetal viability. Observing the female tractus after embryo implantation (seven days after kindling and before the

15th day of pregnancy), both the rate of ovulation and embryo viability can be estimated. The simplest method is laparotomy, to observe the ovaries and uterus. As this usually requires slaughter of the doe, the technique of choice today is the laparoscopy. The effect on the doe is considerably reduced by the use of an endoscope which allows a normal productive life after the operation, and several observations on the same female. Tables 33 and 34 show that strains differ. The way the strains are classified varies between ovulation and birth, i.e. strain 2066 is penalized by poor pre-implantation viability (Table 33).

**Weight gain and anatomical composition.** The growth rates of young rabbits are strongly correlated with adult size and weight where there has been no marked dietary deficiency. Table 35 gives average weights of young rabbits at successive ages, from 28 to 78 days, as well as carcass weights at 78 days, for the Small Himalayan and New Zealand White. The table clearly shows the growth rate of young Small Himalayan rabbits (adult weight 2.5 kg) to be slower than that of the New Zealand White breed (adult weight 4 kg). Moreover, at 78 days the New Zealand White is more mature than the Small Himalayan, when its live weight is 63 percent of adult weight against 59 percent for the Small Himalayan. The variation coefficients, the ratio of the standard phenotype deviation from the mean, are typical of the intrabreed variability of these characters for a given feeding system. Variability is greater in young New Zealand White rabbits than in Small Himalayan. Medium breeds slaughtered at the same age also vary in growth performance and carcass composition. Table 36 gives data for young Fauve de Bourgogne, Argenté de Champagne and Large Himalayan rabbits slaughtered at 84 days. Argenté de Champagne has excellent growth, muscle tissue and fat development for meat production. Fauve de Bourgogne is a close second.

TABLE 32  
**Summary of selected breed comparisons for individual weight at weaning, individual weight at x weeks, litter size at birth and at weaning**

Authors	Charac- ters	Giant Bouscat	Grey Baladi	Red Baladi	Yellow Baladi	Califor- nian	Chin- chilla	White Flemish Giant	Giant Chin- chilla	Grey Giant	White Giant	White Giza	Norfolk	New Zealand White	Sandy	Russian Chin- chilla
Damodar and Jatkar, 1985, India	10 IW								115					1.9*		
Khali <i>et al.</i> , 1985, Egypt	WIN	0.44*									98					
	12 IW	1.00*									102					
Kosba <i>et al.</i> , 1985, Egypt	9 IW	0.63*			67		111									
	12 IW	1.10*			78		97									
Nunez <i>et al.</i> , 1985, Brazil	8 IW					98							102	1.6*		
	12 IW					107							114	2.8*		
Kosba <i>et al.</i> , 1988, Egypt	12 IW		87					1.0*								
	39 IW		79					2.2*								
Affi and Amara, 1987, Egypt	BLS	5.7*		93				99				116		4.9*		
	WLS	3.7*		100				115				123		4.2*		
Damodar and Jatkar, 1985, India	BLS								116							
	WLS								61							
Gugushvili, 1981, USSR	BLS					83			95					8.0*		100
Khali <i>et al.</i> , 1987, Egypt	BLS	6.5*									98					
	WLS	4.9*									95					
Lahiri and Mahajan, 1983 and 1984, India	BLS								134	111				7.8*		102
	WLS								115	141				4.8*		111
Nunez <i>et al.</i> , 1985, Brazil	BLS					93							104	5.9*		
	WLS					107							95	3.6*		
Rahumathulla <i>et al.</i> , 1986, India	BLS													5.3*		94

**Note:** An asterisk after the figure indicates the reference value in numbers or kg; the other values are expressed in percentage with respect to reference value.  
 WIN = individual weight at weaning; xIW = individual weight at x weeks; BLS = litter size at birth; WLS = litter size at weaning.  
 Source: Rochambeau, 1988.

TABLE 33  
Litter size components in three experimental INRA strains

	Strain		
	2066	1077	9077
Ovulation rate	14.5	13.8	13.0
Number of embryos implanted	11.1	12.0	11.0
Number of live embryos at 15 days	9.8	10.4	9.7
Number of live + dead young at birth	8.0	8.2	8.4

Source: Bolet *et al.*, 1990.

TABLE 34  
Litter size components in a sample of 233 V-strain females at the University of Valencia

	Average	Standard deviation
Ovulation rate	15.0	2.1
Number of embryos implanted	12.9	2.6
Number of live embryos at 12 days	12.6	2.6
Number of live + dead young at birth	10.0	2.8

Source: Santagreu, 1992.

Weight gain and the growth rate of the main tissues depend on the breed's biological characteristics and on production factors such as feeding. So the criterion for describing a breed in a particular production environment should probably be maturity in terms of weight, defined as weight at a given age divided by adult weight.

The most interesting breeds from the production point of view are those with the best ratio of weight gain to adult weight, which arrive early at the proper live weight for market. Lightweight breeds could be utilized as pure-breds or, better, crossed with medium-weight breeds for a light carcass with good muscle development and quality meat (sufficient fat) where there is consumer demand.

#### GENETICS OF BREEDING CHARACTERS

The genetic improvement of breeding characters relevant to the production environment depends on the specific genetic vari-

ability expressed in that environment. This variability is expressed in animals of the same breed or local population as well as in different breeds and populations and in interpopulation crosses. Variability is an expression of genetic differences which selection and crossing try to exploit.

The question here is how genetic variability can be exploited in small-scale production, preferably using local resources. Upgrading the potential of a species depends on its biological characteristics, mastery of its reproduction and calculating the genetic parameters for selection.

#### Biological characters

**Controlled breeding.** One breeding operation requiring much care and time on the breeder's part is to get the first and successive litters from the doe. In cage breeding the doe should be serviced in the buck's cage. Once sexually mature the doe can theoretic-

TABLE 35  
**Variability in weights of young rabbits from 28 to 78 days, and carcass weights,  
 for two breeds**

	Small Himalayan		New Zealand White	
	x	v (%)	x	v (%)
Age (days)	Live weight (g)			
28	428	8	599	26
31	485	12	761	16
38	582	8	1 013	14
45	770	9	1 248	13
52	933	9	1 568	15
59	1 105	10	1 860	14
66	1 245	10	2 066	11
73	1 387	10	2 300	10
78	1 476	10	2 503	10
	Carcass weight (g)			
78	911	9	1 364	7

**Note:** Animals bred at INRA (Toulouse Centre). Rational production; weaning at 28 days. Carcasses with head and paws. x= average; v= variation coefficient.

TABLE 36  
**Average live weight at 84 days, carcass weight, muscle weight/bone weight ratio, weight of  
 fatty tissue in carcass, for three breeds**

	Fauve de Bourgogne	Argenté de Champagne	Large Himalayan
Live weight at 84 days (g)	2 143	2 460	2 055
Carcass weight (g)	1 305	1 588	1 287
Muscle weight/bone weight ratio (%)	4.3	4.5	4.0
Weight of fatty tissue in carcass (g)	86	107	73

Source: Rouvier, 1970.

cally be presented to the buck at any time except during gestation, but in practice she does not always accept the male. Acceptance of the male and subsequent mating produce litters only 70 percent of the time. This figure varies with physiological conditions, season, breed and environment. Figure 17 summarizes the respective genetic roles of the buck and the doe in litter size at weaning.

The breeder is dependent on the sexual urges of the buck and doe for the first essential step, mating. Little is known about the biological basis of rabbit sexuality. The urge drops with high temperatures (28° to 30°C). In the hot season the doe must be presented to the buck early in the morning, from 0600 onwards, when the sexual urge is greatest.

Fertility is affected by ovulation, which



FIGURE 17

Respective genetic roles of male and female rabbits in determining litter size at weaning

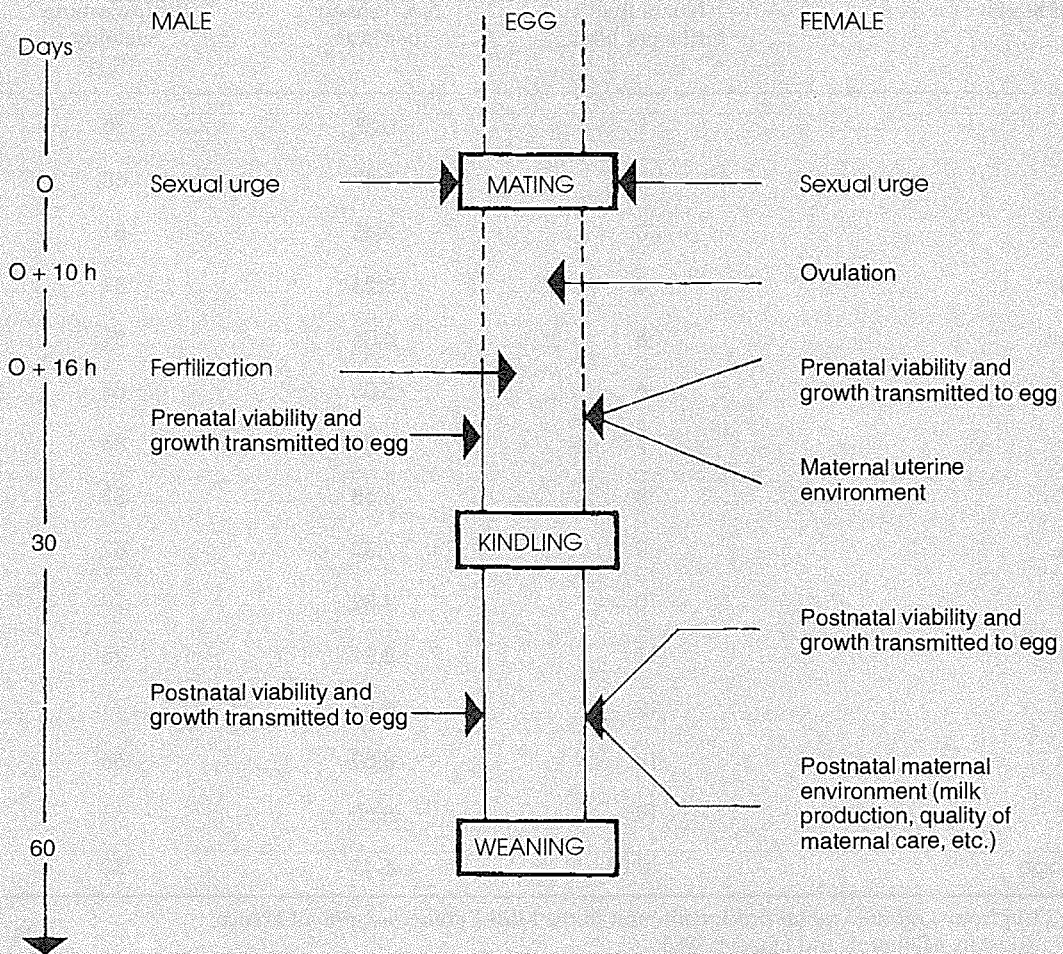

Source: Matheron and Mauléon, 1979.

depends on the doe and takes place ten hours after mating, and by fecundation of the egg, which depends on the buck and occurs 16 hours after mating. The genes of both the buck and the doe equally affect prenatal growth and the viability of the egg. Crossing can improve the viability of the egg, blastocyst and embryo. The doe has more influence in the uterine environment, notably on embryo nourishment. The buck therefore has an influence on litter size.

Doe prolificacy is a breed characteristic, but with substantial individual variations (one to 18 young per litter). Once the doe has kindled, the litter must be safely raised to weaning. The breeder affects litter size at

weaning by protecting the young and by the feed provided for the nursing doe. The viability of the baby rabbits, maternal behaviour and milk production are also important. Kindling-weaning viability in the litter depends on the number of live births, which varies from breed to breed, as shown in Table 37.

This viability remains fairly constant for the number of live births in litters of three to nine. Small litters (one or two live births) do not offer a favourable environment for the survival of the young. Live young at weaning peak at 8.60 for litters of 12 or more. This suggests practical rules for fostering to increase the total production of young rabbits

TABLE 37  
Birth-weaning viability of young rabbits by litter size at birth

No. of litters	No. of live births per litter	No. weaned per litter	Birth-weaning viability (%)
171	1	0.35	35
321	2	1.37	68
487	3	2.43	81
634	4	3.23	81
1 035	5	4.06	81
1 784	6	5.05	84
2 741	7	5.80	83
3 837	8	6.68	83
3 753	9	7.34	82
2 857	10	7.82	78
1 343	11	8.21	75
676	12	8.57	71
221	13	8.59	66
63	14	8.60	61
Average	8.01	6.41	80

Note: Data from a rational rabbit production unit in the Midi-Pyrénées region of France.  
Source: Roustan, Matheron and Duzert, 1980.

weaned. The fostered rabbits may come from small (one or two), or more commonly from large (over ten) litters. However, fostering implies both a sufficient number of does in the rabbitry and the breeder's familiarity with their maternal behaviour. After birth and once the young rabbit has suckled, it can be separated from the mother for 24 hours, allowing for easy travel and transfer to a foster mother.

The biological characteristics of the female rabbit—ovulation induced by mating, acceptance of the male from the day of kindling, no lactation anoestrus, no marked seasonal anoestrus—are such as to afford a wide range of theoretical reproduction rates. As an example, Table 38 compares three different rates of reproduction at a commercial rabbit breeding centre in Mexico.

Both does and bucks have a very high reproduction potential, as confirmed by the latest research. Potential reproduction per doe per year can be evaluated at 150 young. Achieving this, however, will require many more years of research as well as the mastery of environmental factors. For breeding in developing countries it is best at present to aim at using local populations and longer reproductive periods. The best technique is to start by upgrading traditional production techniques and (where they exist) local populations.

*Tissue growth.* As demonstrated by Cantier *et al.* (1969), bone tissue in rabbits develops first, followed by muscle and then fat. In a population of common rabbits of average adult weight (4 kg) the skeleton develops

TABLE 38  
Comparison of three reproduction rates

Breeding characteristics	Rates		
	1	2	3
Breeding does	75	75	75
Age at weaning ( <i>days</i> )	28	35	42
Presentation of doe to buck after kindling ( <i>days</i> )	3	10	17
Rate of acceptance of male (%)	85	84	87
Gestation rate (%)	61	84	87
Theoretical number of litters/doe/year	9.0	8.0	6.95
Estimate of litters/mother-cage/year	7.9	7.5	6.6
Number born per litter	7.6	7.6	7.7
Live births per litter	6.8	6.9	7.0
Number weaned per litter	5.7	5.9	5.8
Average weight at weaning ( <i>g</i> )	520	760	990

Source: Irapuato National Rabbit Breeding Centre, Mexico.

rapidly up to a live weight of 900 g. Growth then continues more slowly up to 4 kg. Muscle tissue gains very quickly in weight up to a live weight of 2.3 to 2.6 kg, when the curve falls abruptly. Adipose tissue develops at a fast rate after 2.1 kg. To allow for the differences in the speed of overall weight gain due to breed or feeding, rabbits should be slaughtered at 50 to 60 percent of the normal adult weight for their breed or population. This is the right stage for the best anatomical composition of the carcass and the most efficient utilization of feed.

Poor feed slows down overall weight gain and lowers conversion efficiency – the amount of feed necessary to produce a 1 kg weight gain. This might not be a drawback in a breeding system using local resources for feeding the growing rabbits, but the fastest growing animals in a population have the best carcass composition (muscle/bone ratio, fat percentage) at slaughter age or weight. Young rabbit meat is naturally lean; there is no excess fat. The best slaughter age and weight must be worked out in terms of

market demand, the production system and the type of feed used.

#### Genes and the environment

Most quantitative breeding characters – fertility, viability, growth, etc. – are polygenetically determined, but they are also subject to the effects of the environment. Phenotype is the outcome of the impact of genotype and environment on a character. The genotype is the outcome of the effects of genes at several loci. The environment is made up of a number of components: climate, habitat, the animals' microclimate, temperature, humidity, air speed, rabbitry equipment, breeding techniques and feeding practices, and the human factor – the breeder. The genetic determination of character variations is of dual interest to the selector and breeder: first, to exploit the genetic variability of animals of the same breed or population; and second, by crossing, to exploit the genetic variability between breeds and populations.

Individual genotypic values are not directly observable, only performance (phenotypes)

TABLE 39

Allometric coefficients of the main organs and tissues and indication of critical body weights (less digestive content) observed in male rabbits

Body weight (g)	Digestive tract	Skin	Adipose tissue	Skeleton	Muscles	Liver
650	1.13	0.44	0.82	0.91	1.20	1.25
850	0.46					
950						
1 000						
1 700	0.86	1.87	0.55	0.47		
2 100						
2 450		3.21		0.50		

Source: Cantier *et al.*, 1989, quoted by Ouhayoun, 1989.

can be measured. The conventional model of quantitative genetics assumes phenotypic value to be the sum of genetic value and environmental factors. This model assumes genotype and environment to be independent. According to this model, genetic value is partly the result of additive genetic value and partly of gene interaction on the same locus (dominance) or different loci (epistasis). Using a regression coefficient, the additive genetic value of an individual is estimated for the performance of this individual and its relatives. A selection programme tries to create genetic progress, i.e. to increase the average additive genetic value of the population.

**Heritability and genetic correlations.** The amount of genetic progress depends primarily on how much of the variance is of addi-

tive genetic origin. This coefficient is called heritability and it is calculated as the ratio of additive genetic variance to total variance. Heritability therefore varies from zero to one. Heritability is also the regression coefficient of an individual's additive genetic value over his/her own performance. Heritability varies with the character, the population studied and environment. It particularly varies with gene frequencies and thus changes in a selected population.

Figure 18 shows the heritability of the principal characters of interest to breeders. Heritability is read clockwise from the left. Female fertility is near zero in terms of heritability. Then, moving clockwise, heritability increases. The heritability of litter size is about 0.10. The highest heritability is for weight at a standard age (0.2 to 0.3) and this increases as the animal grows and maternal influence

FIGURE 18  
Heritability and genetic correlation of production characters in rabbits

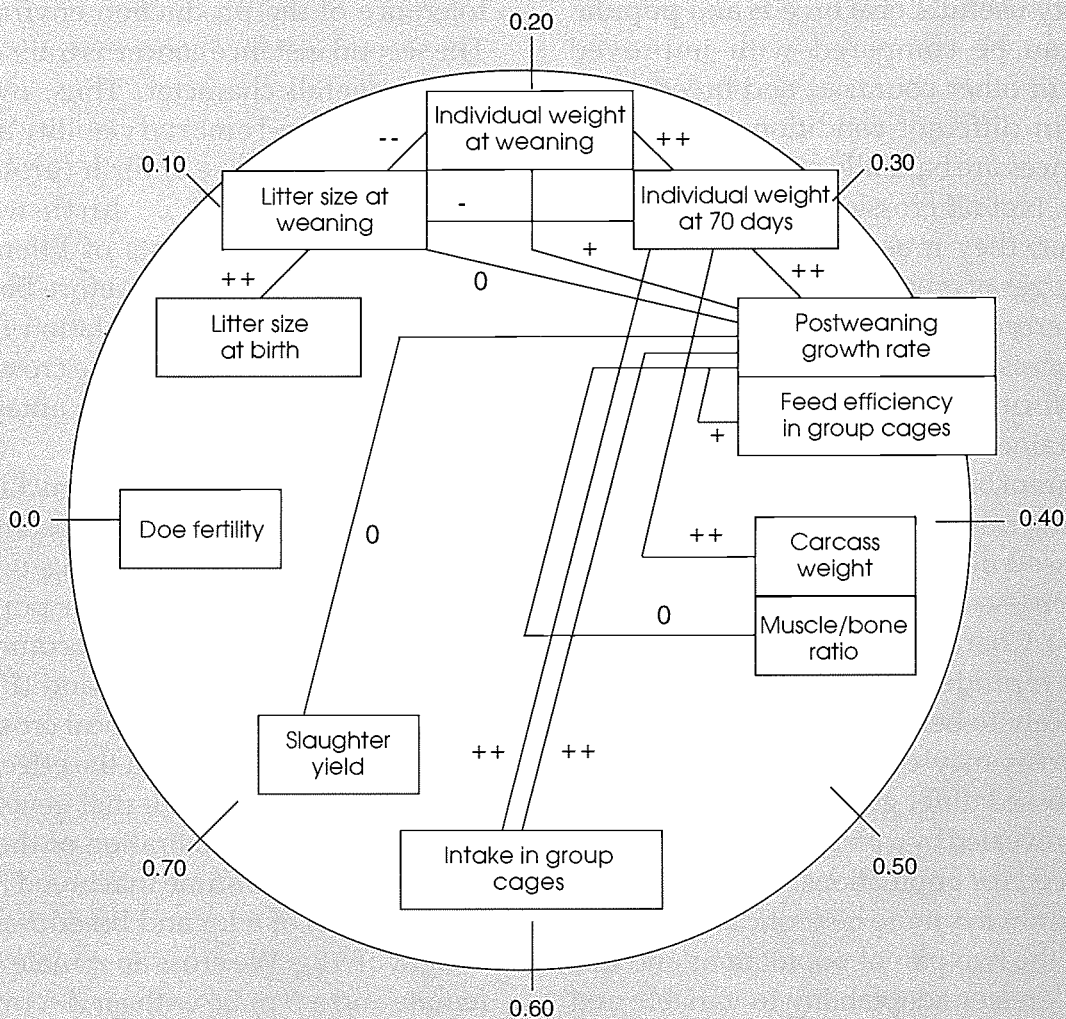

Note: 0: correlation -0.2/+0.2  
+ or -: correlation 0.2/0.4 (+ or - sign)  
++ or --: correlation above 0.4 (+ or - sign)

Source: Masoero, 1982.

wanes. Postweaning growth rate and feed efficiency in collective cages are between 0.3 and 0.4. Above 0.4 lie characters such as carcass weight, muscle/bone ratio, intake in a group cage and slaughter yield.

These estimates are relative: the problem of estimating a variance ratio with the available data is compounded by variations of heritability in place and time. Rochambeau's 1988 review is an instructive illustration of

this: heritability for the number of live-born young varies from 0.0 to 0.4 when the upper quarter and lower quarter estimates are removed. The variation for individual weight at 14 weeks is 0.2 and 0.8 under the same conditions.

**Genetic variability among breeds and populations.** Local breeds or populations could be compared with improved breeds in other

countries and under different production systems. Breed differences are primarily exploited through cross-breeding. Interbreed comparisons in rabbitries are therefore very useful. Local breeds and populations can be compared with improved breeds in other countries and breeds produced in different conditions. Interbreed differences are basically exploited through crosses. Not all crosses are advantageous, however; they must be tested. The main advantages of cross-breeding are heterosis and interbreed nicking ability.

Heterosis may be defined as better breeding performances of crossed animals than that obtainable with the average of the two pure parent breeds. Heterosis may apply to the young rabbit (its viability, for example), the crossed doe (fertility, milk production) or the crossed buck (vigour, sexual urge, fertility). Characters subject to dominance, such as reproduction characters, are those most likely to benefit from heterosis.

Heterosis may occur where the populations crossed differ genetically, which is not always revealed by a phenotypic study of the pure breeds or populations. The crossed animals are always more heterotic than the animals of the two parent populations and this implies greater adaptability to variable and difficult environmental conditions. Crossing can therefore be useful in improving rabbit breeding in developing countries, but crossing trials must be planned. Where local populations exist their use is recommended.

Cross-breeding makes possible the optimum use of the nicking ability of the breeds or populations crossed. Nicking ability concerns the two groups of characters from the mother and her young which contribute to the quantity of rabbit meat produced by the doe. In cross-breeding this ability is aimed at bringing together either the overall characters relative to the mother and the offspring, or a favourable combination of additive effects on the components of an overall character.

In the first instance, bucks of a breed with high growth potential are crossed with does of another breed or population that exhibit good prolificacy, maternal performance and tolerance of the production environment. The second instance concerns traits making up an overall character. Thus, ovulation rate and egg and embryo viability are components of litter size at birth (prolificacy). Prolificacy and birth-weaning viability are components of litter size at weaning. Crosses can therefore be sought which combine a high ovulation rate and strong embryo viability in the crossed doe. These characters may well be antagonistic on an intrapopulation basis.

The effects of heterosis and nicking ability are not systematic. Crossing programmes are needed to bring out these effects clearly. Let us consider population *A* and population *B*. It is recommended that two pure-bred ( $A \times A$ ) and ( $B \times B$ ) be compared with two reciprocal crosses ( $A \times B$ ) and ( $B \times A$ ), to highlight the effects of the maternal and grandmaternal generations.

As an intuitive illustration of the maternal effect, let us assume that breed *A* has an adult weight of 6 kg and breed *B* an adult weight of 3 kg. We cross an *A* male with a *B* female and a *B* male with an *A* female, and compare the weight of the young at weaning. The young *AB* rabbits have the same genetic heritage on average as the young *BA* rabbits, as they share half of the paternal and half of the maternal genes. The young have a different maternal environment, however: *A* females have a larger uterus and produce more milk so the young weigh more at weaning. Thus, even with the same genetic heritage, *BA* rabbits are heavier at weaning than *AB* rabbits because of the favourable maternal effect. A more precise definition is given in Matheron and Mauléon (1979). It is recommended that two successive generations of crosses be studied to bring out the direct effect of heterosis on rabbit characters and on the

maternal effects, as expressed in the female characters. The first generation includes crosses ( $A \times A$ ), ( $B \times B$ ), ( $A \times B$ ) and ( $B \times A$ ); the second consists of mating pure  $AA$  and  $BB$  females and half-breed  $AB$  and  $BA$  females with, for example, males of a third  $C$  strain. If more than two populations are studied, the number of genotypes to compare at the second generation increases with the square of the number of populations.

One example is provided by an INRA experiment at the Toulouse Centre in 1987 to 1989. This three-stage experiment used strains 1077, 9077 and 2066, as shown in Table 28, p. 67. The first stage involves a factorial mating between males and females of three strains: males of each genotype (1077, 9077 and 2066) are crossed with females of each genotype (1077, 9077 and 2066) to obtain litters with nine genotypes (three pure and six cross-bred). At stage two, females from these nine genotypes were mated with males of three pure genotypes. At the last stage, the same females were mated with males belonging to two strains of terminal crossing of different origin. The first three litters of the female were checked at each stage. The females were then slaughtered during their fourth pregnancy and litter size components studied.

Table 40 compares the performances of pure and cross-bred females. Cross-bred females were superior on the whole, the number rising from ovulation to weaning at a rate of one to 13 percent. There are also differences between the pure strains and cross-bred females. The following analyses attempt to explain these differences for further use. 2066 females have a better ovulation rate but this advantage disappears at the next stage. The performances of 2066 and 1077 are fairly close. The 9077 strain performs less well.

Cross-bred genotypes with 2066 genes also have a higher ovulation rate: an advantage maintained up to weaning, where the

genotypes 2066  $\times$  1077 and 1077  $\times$  2066 confirm their superiority. Litter size is considerably increased by the use of cross-bred females.

Table 41 analyses the same findings in terms of genetic effect. For direct genetic effect, 2066 has a negative effect on the number of implantation sites and 9077 has a positive impact on litter size at birth. The maternal effect of 9077 on the number of implantation sites contrasts with the positive effect of 1077 on litter size at weaning. While the effect of direct heterosis is weak, maternal heterosis has a major effect on the number of implantation sites and is maintained until weaning, achieving 16 percent for 1077 and 2066.

The results of crossing experiments, of particular interest in selecting an optimum animal utilization strategy, are specific to the animal population studied and cannot be generalized for all animals in a breed. However, they can describe local populations or strains, thus selecting the best way to use them in cross-breeding or pure-breeding.

***Cross-breeding in tropical countries.*** The biological bases for superior crosses should be sought among the available animal populations bred in various environments. Several large-scale studies of interbreed crosses in tropical countries have been made: there follows one from Cuba, and then a synthesis of experimental work in Egypt.

These studies were made on animals from imported acclimatized breeds, not on local rabbit populations. Meat production was improved by using the best crosses. In 1969 to 1971 the Cuban *Instituto de Ciencia Animal* crossed four breeds on a rotational basis: Semi-giant White, Californian, New Zealand White and Chinchilla. The characters analysed were litter size at birth and weaning, and litter weight at weaning. The experiment was conducted during the dry season (November to April, mean temperature 22.2°C, humidity 75.2 percent) and the

TABLE 40  
Average female performance in nine genotypes: litter size components measured at different stages

Female genotypes*	Number of corpus luteum	Number of implantation sites	Litter size at birth	Litter size at weaning
9077 x 9077	13.0	11.0	7.8	6.9
2066 x 2066	14.5	11.1	8.5	7.2
1077 x 1077	13.8	12.0	8.6	7.5
Average	13.8	11.4	8.6	7.5
2066 x 1077	15.2	13.4	9.9	8.7
1077 x 2066	15.3	13.1	9.9	8.8
1077 x 9077	12.4	10.9	8.5	7.4
9077 x 1077	12.7	11.0	8.8	7.8
9077 x 2066	13.5	11.9	8.7	7.9
2066 x 9077	15.0	12.5	9.4	8.3
Average	14.0 (+1%)	12.1 (+6%)	9.2 (+11%)	8.1 (+13%)

\* Paternal genotype followed by maternal.  
Source: Brun, Bolet and Ouhayoun, 1992.

TABLE 41  
Genetic parameters of litter size measured at different stages between ovulation and weaning

Parameters	Genotypes	Implantation sites	Litter size at birth	Litter size at weaning
Direct genetic effects	9077	0.8	0.4	0.3
	2066	- 1.2	- 0.4	- 0.2
	1077	0.4	0.0	- 0.1
Maternal effects	9077	- 0.9	- 0.8	- 0.4
	2066	0.5	0.5	0.0
	1077	0.4	0.3	0.4
Direct heterosis	2066 x 1077	3	5	0
	1077 x 9077	- 1	1	0
	9077 x 2066	- 1	3	6
Maternal heterosis	2066 x 1077	15	15	16
	1077 x 9077	- 4	7	7
	9077 x 2066	10	9	15

Source: Brun, Bolet and Ouhayoun, 1992.

rainy season (mean temperature 26.1°C, humidity 77.7 percent). Some of the experimental animals from these four breeds had recently been imported from Canada, others had been in Cuba for some time. Adult weights are given in Table 42.

The animals were raised in hutches identical to those used for rabbit breeding in southern California. These are wire cages with wooden nesting boxes arranged in single decks in two rows, in a roofed building open on all four sides. This habitat pro-



protects the rabbits from direct sun but in a wet tropical climate cannot protect against rain and wind, which explains the high mortality rate of the rabbits before weaning.

An extensive system of reproduction was used, with weaning at 45 days, followed by mating. The average figures on litter size show a normal prolificacy for breeds of this adult size (7.45 total births per litter); slightly higher than normal stillbirth rate (over 10 percent); and, above all, a high birth-to-weaning mortality (2.5 rabbits weaned per litter). This was caused by inadequate protection of the nests from wind and rain and inadequate feeding of the lactating does. It is interesting to know the positive contribution of cross-breeding in such difficult production conditions.

A comparison among the pure breeds revealed that the Semi-giant White loses fewer young between kindling and weaning than the others, and the weaning weight is better. For simple crosses the highest averages for number of young weaned and lowest total rabbit mortality figures were recorded by New Zealand White x Semi-giant White. Numerical productivity can also be increased by crossing the female progeny of this cross with Californian males. The most productive cross is Semi-giant White does x Chinchilla bucks.

Afifi and Khalil (1992) summarized the findings of nine Egyptian experiments published between 1971 and 1990. They compared pure and cross-bred animals from local or imported populations. There is a long list of breeds used: Bouscat, Chinchilla, Giza White, Baladi White, Red and Yellow, Grey Flemish Giant, White Flemish Giant, New Zealand White and Californian. The trial designs include many simple crosses but, unfortunately, few cross-bred females. The authors of the summary conclude that local breeds (Giza White, Baladi) are superior for characters expressed before birth and the imported breeds (New Zealand White, Californian, Bouscat) bet-

ter for postnatal characters. The review includes a great many estimations of the effects of direct heterosis, here summarized in Table 43. In these experimental environments, the direct effects of heterosis proved weak for the characters studied. Apart from an average value of 15 percent for litter weight at birth and 7 percent for litter size at weaning, all other values were below 5 percent. They are close to zero for individual weight at four and 12 weeks and for postweaning viability. The effects of maternal heterosis are stronger, even though the low number of experimental results does preclude a categorical statement.

#### **GENETIC IMPROVEMENT: SELECTION AND CROSSING**

France, Italy and Spain in southwestern Europe are developing genetic improvement programmes to meet the needs of intensive production in a temperate climate. Animals selected in Western Europe are not necessarily the best for small unit production (five to 60 does) in different production conditions. Local rabbit breeds and stock bred locally using various imported populations should be used for genetic improvement.

Efficient genetic improvement should be a group effort with scientific and technical support from the country's research and development organizations. The improvement programme could focus on a village (or preferably a group of villages), on all the rabbitries in a province, or on the whole country. Genetic improvement is a costly operation: the group needs to be big enough to bear the cost and to mobilize the necessary skills.

Genetic improvement demands technical specialization. There should therefore be breeder-selectors and breeder-users, perhaps with breeder-multipliers between the two. While the pyramidal schemes used in Western Europe are efficient in their special context, they are not universally

TABLE 42  
Adult live weight of four breeds in a Cuban cross-breeding experiment, 1969 to 1971

Breed	Weight of females	Weight of males
	(kg)	(kg)
Semi-giant White	4.05	3.95
Californian	4.05	3.87
New Zealand	3.80	3.90
Chinchilla	3.98	4.20

TABLE 43  
Distribution of the effects of direct and maternal heterosis in a series of cross-breeding experiments in Egypt

Character	Distribution of effects of heterosis									Average
	N*	-10<	-5<	0<	5<	10<	15<	<20	20≤	
Litter size at birth	43 6	1	8	5 2	11 2	6 1	4	3	5 1	4 5
Litter size at weaning	43 6	4	3	7 1	6 1	11	5 1	2 1	7 1	7 14
Litter weight at birth	32 0		1	1	5	6	6	7	7	15
Litter weight at weaning	34 4	4	4	2	7	6 1	4 2	4	3 1	5 13
Individual weight at five weeks	36 5	4 1	5	6 2	11	5 1	5 1			1 1
Individual weight at 12 weeks	32 5	2 1	3	7 1	7 1	10 1	3 1			2 0
Four to 12 week viability	17 2	3	6	1	2 1	1			3 1	1 12

\* N = number of estimates. For each character, the direct effects of heterosis are noted on the first line and the effects of maternal heterosis on the second line.

Source: Afifi and Khalil, 1992.

applicable. It is up to the individual to conceptualize networks tailored to the sociospecifics of the country's breeders (although the networks must be genetically efficient). The selectors should also be excellent breeders, making use of production systems, feed resources, housing and other materials adapted to the environment. Sophisticated selection facilities should be avoided, as the objective is to match the best local systems. Health care and sanitation, in particular, must be exemplary.

A selection unit must be effective on two levels: breeding and production. The extra costs entailed in the technical side of the selection work should be borne by the group of breeders benefiting from the genetic improvement. The cost of research devoted to a genetic improvement programme for the whole country should be shared by a larger group. There are several conceivable types of organization. With French assistance, Mexico experimented with a pyramidal system (1976 to 1982) with a

state-supervised national breeding station and regional multiplication stations. Development agencies distributed breeding animals to family-scale rabbitries.

Research and development agencies should focus on: first, the real efficiency of selection methods and creating new genetic material to improve rabbit production in the country; and second, the best strategies for utilizing local and exogenous animal populations, making breed comparison studies, doing cross-breeding experiments and testing strains.

The object of selection is to upgrade performance by enhancing an animal's genetic value where husbandry and feeding techniques permit expression of genetic value. In fact, breeding and feeding techniques must be improved at the same time as the genetic value. Selection and crossbreeding should increase the annual output per doe and speed the growth rate for earlier slaughter and better carcass and meat quality.

The definition of a selection trial design requires both the choice of a method and the review of its theoretical efficiency. The crossing is a supplementary benefit to intrapopulation selection. But genetic progress from cross-breeding is not cumulative from one generation to the next, as is progress from selection, except where selection is used to improve crossing. The following are examined below: selection methods, cross-breeding strategies and organizing genetic improvement.

#### **Selection methods**

*Characters and criteria for selection.* A major objective of selection is to improve annual fecundity per doe. This global character depends on the breeder, the animal and the environment. The breeder establishes the theoretical reproduction rate of the does. For backyard rabbitries, it is assumed that weaning takes place at 42 days, servicing at 24 days after kindling, and the

average conception rate is 70 percent. This gives an average of six litters per doe per year.

A culled doe is immediately replaced by a young doe ready for mating. If the stock renewal rate is 100 percent per year, the annual numbers of litters per doe will be roughly 5.5. If an average six young per litter are weaned and 5.5 reach slaughter or reproduction age, the objective is then 30 rabbits per doe annually.

This modest goal is realistic for backyard rabbitries not based exclusively on pelleted feed. If necessary, the weaning age can be extended by delaying presentation of the doe for servicing beyond day 24. The theoretical reproduction rate can be stepped up if the goal is too easily achieved or too modest in terms of the potential of the stock and environment. The doe could be brought for servicing at day 17 after kindling with weaning at 35 or 42 days. This would give an additional litter per doe, raising the annual goal to 35 rabbits per doe. A more intensive breeding objective could produce 40 to 50. For many countries, however, this would not be a realistic goal.

Whatever reproduction rate is adopted, it is important to have fertile does which accept the buck and can produce many large litters with good kindling-to-weaning survival rates. This implies a whole range of characters: acceptance of the buck, gestation, fertility, viability of young, milk production and longevity. These characters and performances can be summed up by the selection criterion: average number of weaned per litter from the first three litters obtained within a predetermined period. There is a close correlation between performance during the first three litters and the doe's total output. In practice, the following principle could be followed:

- after the second litter, calculate the selection index of the doe based on the average young weaned per litter;

- divide this index by the number of days between the first kindling and the  $n$ th kindling (for index for  $n$  litters). This gives an index of numerical productivity;

- compare does with the same numbers of litters against this index.

As weaning age is variable, the number of rabbits weaned can be calculated on litter size at 28 days so the doe's genetic value can be estimated more rapidly.

Chapter 9 describes an even simpler system of choosing breeding stock, which can be done directly in the rabbitry.

The other group of characters for selection has to do with weight gain. One selection criterion is average daily weight gain from weaning to slaughter age, say at day 70. The difference between individual weight at day 70 and individual weight at weaning is divided by the number of days elapsed between these two dates. The idea is to speed up postweaning growth. There is no need to measure the quantity of feed consumed, except for experimental purposes or to compare genetic types for selection for feed utilization.

It is not easy to measure the quantity of feed or dry matter eaten by the animals, and when they are given different feeds and local forage feed conversion efficiency is difficult to calculate. Speeding up postweaning growth indirectly reduces the amount of dry matter needed for every kilogram of live-weight gain.

Slaughter yield, carcass quality (meat/bone ratio, fat) and organoleptic qualities of meat are complex characters to select for because they can only be measured in carefully controlled slaughter conditions. Direct intrapopulation selection for these characters would be unrealistic. Breeders can check sample figures for these characters for the population they are using and if improvement is necessary crosses can be made with bucks from good meat breeds (described earlier in this chapter).

*Performance control and technical data management.* With stock being used for selection it is necessary to:

- identify each breeding animal individually;
- measure the breeding characters needed for genetic and breeding management of the stock;
- record these characters for later exploitation.

All rabbits are identified at weaning when separated from the dam by a numbered ear tag or a number tattooed in the ear. This might be the date of birth plus a day-of-year identity number. Depending on the size of the group an individual number might have four or five digits (up to 999 or 9 999 births a year) or even six if necessary. Another number indicating genetic type (breed or cross) could be added to the animal's cage card.

Troop management involves three types of record card: doe, buck and litter. The buck and doe cards identify the breeding animal, its number, date of birth and the number of its sire and dam; next, the animal's cage, for easier identification within the production system; then the date and cull rate.

On doe cards (see Figure 45, p. 158) record:

- servicing dates (day, month and year);
- identification number of servicing buck;
- result of pregnancy test by abdominal palpation;
- kindling date and litter: parity of doe, number of live and stillborn young (found living or dead at first examination of nest after kindling) and number added or subtracted from litter 36 hours after kindling;
- weaning dates, number weaned per litter and weaned litter weight;

On buck cards (see Figure 46, p. 159) record:

- date of servicing;
- number of does serviced;

- outcome of abdominal palpation;
- number of live and stillborn young.

While the buck card repeats some of the doe card data, it is very useful for following the pregnancies and prolificacy of does mated to that buck.

A litter card shows:

- litter birth date, number of dam and sire, weaning date per litter and per individual offspring;
- the young rabbit's number, weaning weight, and the preslaughter weighing date and weight.

A "remarks" column on each card allows the breeder to add observations (e.g. animal's health). These cards are designed for manual or computer processing and are used for daily breeding management, genetic management and, perhaps, experimentation.

There are software programs for desk-top computers which collect this data on a daily basis and edit the breeder's workplans (particularly for mating, palpations, kindling and weaning). These can calculate the various balance sheets of the enterprise.

**Choosing a selection system.** Having chosen selection objectives and criteria, the next thing is to determine the selection system that will maximize genetic progress. This is dependent on three parameters: selection intensity, selection precision and the intergeneration gap.

Selection intensity depends on the percentage of individuals retained. Assume, for example, that 100 rabbits are weighed and ten chosen to breed. The rest are slaughtered and so the percentage is equal to 10 percent.

Selection precision depends on the heritability of the character, the number of measurements and the degree of relatedness between the selection candidate and the rabbit measured. For instance, in selecting for litter size, recording the data for the three first litters, not just the first, makes for greater precision. In selecting for slaughter

yield, on the other hand, precision diminishes if the rabbits measured are five fraternal half-siblings of the candidate and not five full siblings.

The generation interval is the age of the parents at the birth of their average progeny and it increases if females are chosen after the third litter instead of after the first. There is a conflict between trying to be more precise and trying to reduce the generation interval.

In the end, genetic progress depends on the additive genetic variance of the character, a parameter assumed here to be constant.

There are four selection methods:

- mass or individual selection: measured on the selection candidate;
- pedigree selection: measured on the candidate's ancestors (parents, grandparents, etc.);
- sibling selection: measuring the candidate's siblings (full and half-siblings, etc.);
- progeny selection: measuring the candidate's progeny (young, etc.).

Table 44 illustrates the advantages and drawbacks of each method with respect to the three parameters of genetic progress.

These four methods are complementary: pedigree selection provides an initial sifting of selection candidates when the geneologies and performances of the sire and dam are known. This choice is not very exact however. Mass selection is the simplest and most efficient method and as such is the method of choice. Sibling selection is more complex, but is useful for greater precision when the character selected for is not easily heritable, such as litter size, or when the candidate has to be slaughtered in order to measure the character. Progeny selection is not much in use for rabbits as it considerably increases the generation interval and is very expensive.

Table 45 summarizes the findings of selection experiments on rabbits. It shows that

TABLE 44  
Four selection techniques compared for effectiveness

	Mass selection	Pedigree selection	Sibling selection	Progeny selection
Intensity	Average	High	Average	Low
Precision	Average	Low	High to average	High
Generation interval	Average	Low	Average	High

selection is an effective way of increasing litter size and postweaning growth rate, although there is usually almost no progress in litter size. Successful selection depends on full control of rabbit breeding, the collection and management of geneological data and performance, and the selection cycle.

In practice, a synthesis of various theoretical studies suggests the following recommendations.

To improve litter size, the selection criterion is litter size at birth or weaning, measured on the first three litters. For greater precision without increasing the generation interval, the performances of the candidate's full sisters and half-sisters are taken into account. Renewal with the progeny of the female's second or third litter is the next step. Rearing the rabbits in separate generations, as described below, increases selection efficiency but the rabbitry has to be much bigger. It is pointless to attempt selection without the necessary resources.

For a better postweaning growth rate, the selection criterion should be the speed of growth after weaning. This criterion can be measured on both sexes and heritability is average. Simple mass selection is therefore the technique of choice. In order not to reduce the strain's aptitude for reproduction, breeding animals are chosen in litters with at least one shared character and at least four or five births.

A breeder who renews the herd on the basis of the best does for litter size will choose the young rabbits from the litters of

these females which weigh the most at slaughter time. In any case, unhealthy young rabbits are culled prior to selection.

*Renewal of pure-bred stock and mating programmes.* Here there are different cases to consider: first, a rabbitry practising combined selection based on litter size; second, mass selection based on the same character for a sizeable number of breeding does in the strain (200); and third, smaller groups.

*Case 1. Selection of a strain on the basis of litter size at weaning (INRA, Toulouse). Combined selection, separate generations.* The theoretical plan calls for raising the stock in separate breeding groups, each group constituting a generation. In each generation 196 does are bred with a batch of 42 males. Twenty-five percent of these does are selected according to the results of the first three litters, the theoretical reproduction rate permitting a generation interval of ten months. Each doe selected produces an average of four replacement female offspring, so the group is made up of families of full sisters and paternal half-sisters.

The mating programme is implemented in accordance with the composition of the breeding groups. Table 46 shows that the females of each of the 14 families are distributed among 14 breeding groups with three males (one and two alternates) and 14 females. One breeding female is chosen at random per family from among the 196 does.

This mating programme means the genetic value of each doe can be figured

TABLE 45  
Findings of specific selection experiments on rabbits

Authors	Characters selected	Genetic progress per generation <sup>1</sup>	Strain size	No. of generations
Poujardieu <i>et al.</i> (1993, pers. comm.)	Litter size	+ 0.05	33 M and 121 F	18
Baselga <i>et al.</i> (1993)	<i>Idem</i>	+ 0.10 + 0.03	24 M and 120 F 24 M and 120 F	11 8
Mgheni and Christensen (1985)	<i>Idem</i>	+ 0.35 - 0.43 <sup>2</sup>	20 M and 40 F 20 M and 40 F	4 4
Narayan, Rawat and Saxena (1985)	<i>Idem</i>	- 0.05	22 M and 110 F	6
Rochambeau <i>et al.</i> (1989)	Individual slaughter weight	+ 46 g and + 2.4%	12 M and 30 F	8
Mgheni and Christensen (1985)	<i>Idem</i>	+ 75 g and +3.4% 108 g and - 4.3% <sup>2</sup>	20 M and 20 F 20 M and 20 F	4 4
Estany <i>et al.</i> (1992)	<i>Idem</i>	+ 27 g and 2.0% + 23 g and 1.6%	15 M and 60 F 15 M and 60 F	12 8

Note: M = males; F = females.

<sup>1</sup> Expressed in gross and percentage of average.

<sup>2</sup> Selection to reduce value of characters selected.

according to her performance and those of related females (family average). The plan can also be implemented with fewer than 14 families and 14 breeding groups (e.g. 10, or a total of 100 breeding females). The breeding groups system offers the practical advantage of matching a production layout in which families are represented by mother cages. Here, the 14 doe cages and the three buck cages are arranged side by side in rows in the rabbitry.

Rearing the generations separately has a number of advantages: the animals compared are the same age and so it is easier to calculate selection indices and estimate genetic progress. It also makes it easier to create a gap between the generations for health purposes.

There are a number of drawbacks, however. If female fecundity is too low it is impossible to produce a new generation every two months. Optimal use of available cages is also impossible and the occupation rate is low. Many breeders therefore

prefer a system of overlapping generations (Case 2), but the system does demand a strict adherence to management rules.

*Case 2. Selecting a strain for postweaning growth and female fecundity (IRTA, Barcelona, Spain), mass selection and overlapping generations.* The selected population includes six breeding groups composed of 16 does and five bucks. As in Case 1, the males remain in their breeding group and one sire is replaced by one male offspring. The females change group: the daughter of a doe is never in the same group as her dam.

Selection is in two stages: first the does are indexed by postlitter weaning weight of their litter. Only does in the first and second kindling category and does in the bottom 20 percent leave no progeny. Does with a negative index are culled as soon as a replacement female is available. All does are culled after the fifth kindling, as are males over the age of 13 months.

In the second selection stage, future breed-

TABLE 46  
Formation of reproduction groups based on family origin

	♂ 1.1	♂ 2.1	♂ 3.1	♂ 14.1			
Family 1	♀ 1.1	♀ 1.2	♀ 1.3	♀ 1.14	♂ 1.1	♂ 1.2	♂ 1.3
Family 2	♀ 2.1	♀ 2.2	♀ 2.3	♀ 2.14	♀ 2.1	♂ 2.2	♂ 2.3
Family 3	♀ 3.1	♀ 3.2	♀ 3.3	♀ 3.14	♂ 3.1	♂ 3.2	♂ 3.3
Family 14	♀ 14.1	♀ 14.2	♀ 14.3	♀ 14.14	♂ 14.1	♂ 14.2	♂ 14.3
	G1	G2	G3	G14	Males used	Replacement males	

Source: Matheron and Rouvier, 1977.

ers are chosen from the progeny of the does selected earlier. The final selection is for animals with the greatest daily weight gain between weaning and sale. Twenty-five percent of the does and 15 percent of the bucks of the weaned population of each lot are kept as replacements as needed.

This set of rules governing the selection and culling of breeding animals is designed to maintain a population in demographic equilibrium and increase selection efficiency.

*Case 3. Conservation of a numerically small strain.* It may be useful to conserve strains or populations that are few in number. Matheron and Chevalet (1977) proposed an appropriate management method (used to manage control strain 9077 at INRA).

The strain is composed of 11 breeding groups with one male and four females. From one generation to the next, each male leaves one male progeny and each doe one female progeny.

The male of group  $i$  is the offspring of the  $i$  male of the preceding generation. His dam is chosen at random from females in the breeding group. The four females making up group  $i$  in generation  $n+1$  are the daughters of four females who were, respectively, in groups  $i-1$ ,  $i-2$ ,  $i-3$  and  $i-4$  in generation  $n$ . This method is illustrated in Figure 19.

Once the breeding animals for herd renewal have been chosen, a mating programme is the next step. Selection may be random, but mating between close relatives such as full brothers-sisters, half-brothers-half-sisters, mother-son or father-daughter must be avoided. A practical way to organize a servicing calendar is to assign breeding animals to cages by breeding groups, taking family origin into account (the family is the original breeding group). A breeding group consists of two or three cages of sires and 10 to 14 cages of dams, or proportionately fewer if the colony is numerically small.

#### Cross-breeding strategies

Three cross-breeding systems are:

*Simple or two-breed crossing.* Females of a local population, or breed A, will be crossed with males of breed C to improve the growth and muscular development of young meat rabbits and for a heterotic effect on the numerical productivity of does. Using this system the breeder can cross the pure breed A with part of his/her stock (perhaps 20 percent) for self-renewal of the female stock. The other females will be terminally crossed with C males, which can be obtained from another breeder. All the progeny of this cross are destined for the butcher.



FIGURE 19  
Constitution of generation  $n + 1$  groups, the progeny of  $n$  generation breeding groups

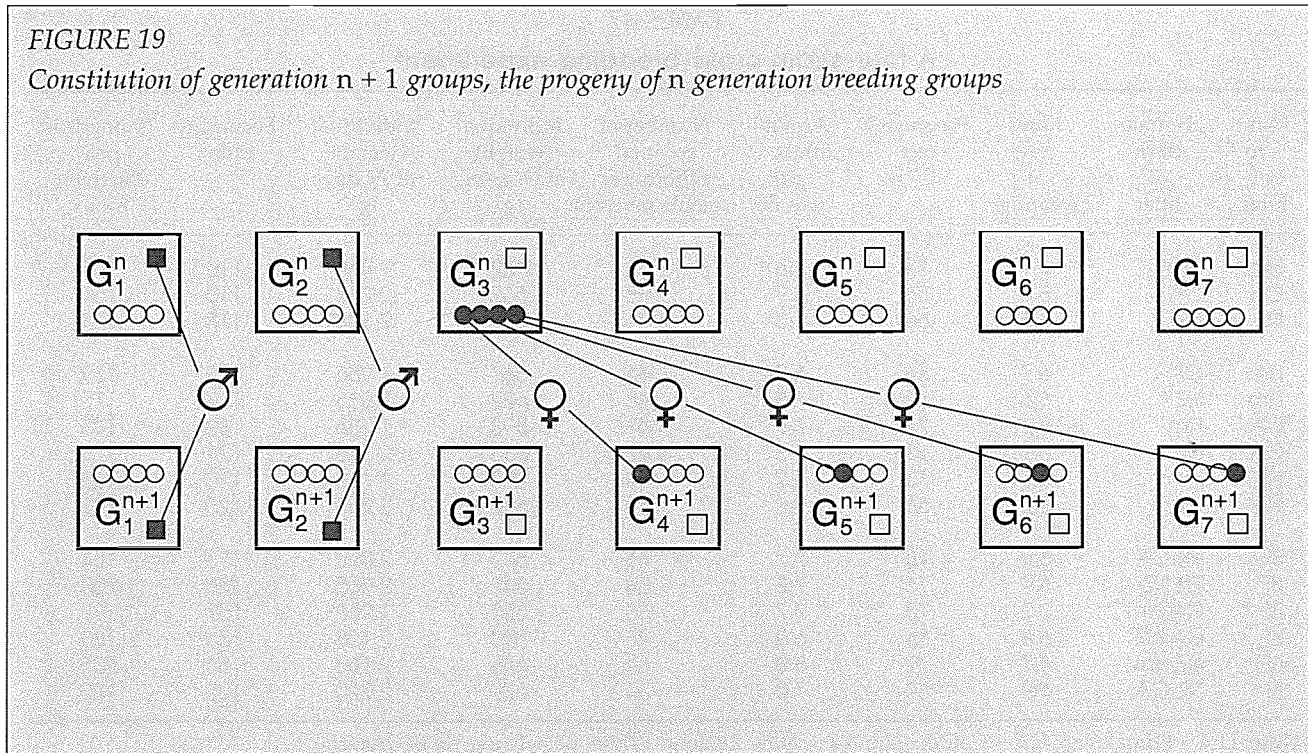

**Two-stage or three-breed crossing.** Breeding animals of two populations (*A* and *B*) will be crossed to get an *AB* crossed female for terminal crossing with males of breed *C*. The first crossing might be between *B* males of a good breed for size, fertility and maternal performance with females of a local *A* population. Using this system the breeder must rely on breeders or multipliers for female *AB* breeding animals and *C* sires, which demands careful timing and organization.

The system can be elaborated by the use of *C* sires which have themselves been crossed according to a system widely used in poultry breeding.

Table 47 compares the performance of three pure strains, *A*, *B* and *C*, simple strains *AB*, *BC* and *AC* and double crosses  $D \times AB$ ,  $D \times BC$  and  $D \times AC$ . It shows substantial production differences between the pure strains. Simple crossing improves overall performance. The best of the pure strains is still competitive, however. Crossing a male of a fourth strain, strain *D*, with cross-bred females *AB*, *BC* or *AC* further increases productivity. This is the most productive yet most complex system.

**Rotating and alternative cross-breeding.** Using several breeds and local populations for improvement, such as *A*, *B* and *C*, the breeder can apply the following system:

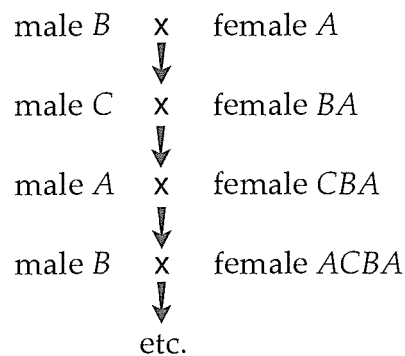

The advantage of this system is that it offers both heterosis and nicking ability and breeders can themselves produce their female replacement stock; only the male breeding animals need to be acquired elsewhere. When this system is used with only two breeds it is called alternative cross-breeding.

Systems one and three, in which breeders acquire male breeding animals for stock improvement but can select females from their own rabbitry, are well adapted to small-scale production.

TABLE 47  
A four-strain cross-breeding experiment

Male sire of litter	Female dam of litter	Litter size at weaning	Pregnancy rate (%)	Annual litters per female	Number of weaned rabbits per female per year	Individual weight at weaning (g)	Individual weight at 77 days (g)	Fecundity index	Numerical productivity index
Hm	Hm	4.9	73	7.6	38	422	1 455	110	100
CA	CA	5.6	56	6.9	38	562	2 237	110	154
NZ	NZ	5.6	63	7.3	41	609	2 348	118	174
Hm	CA	6.7	56	6.9	46	567	1 956	129	159
Hm	NZ	6.6	63	7.3	48	622	2 035	137	175
CA	Hm	6.1	73	7.7	47	398	1 736	132	143
CA	NZ	5.7	63	7.3	42	633	2 316	121	175
NZ	Hm	5.5	73	7.7	42	490	1 768	120	132
NZ	CA	6.2	56	7.9	42	584	2 269	120	171
BF	PR.CA	5.9	73	7.7	46	572	2 022	133	184
BF	PR.NZ	6.9	76	7.8	54	542	2 055	155	200
BF	CA.Hm	7.2	73	7.7	55	553	1 988	157	195
BF	CA.NZ	6.8	56	6.9	47	600	2 158	135	183
BF	NZ.Hm	6.7	79	8.0	54	645	2 156	153	205
BF	NZ.CA	4.9	57	7.0	34	629	2 220	100	140

Note: Hm = Himalayan; CA = Californian; NZ = New Zealand White; BF = Fauve de Bourgogne.  
Source: Vrillon *et al.*, 1979.

**Synthetic strains.** Many countries have few or no local rabbit populations. Where they do exist, they are often the descendants of random imports dating back a few decades and crossed with no overall strategy. This population may have adapted somewhat to local conditions, but its initial genetic potential will be rather limited. For such countries, the creation of synthetic strains is an attractive alternative.

To create a synthetic strain, a male from strain *C* is mated with a cross-bred *AB* female to produce an  $F_1$  generation which is crossed  $F_1 \times F_1$  to produce  $F_2$ , followed by  $F_3$  and so on. A synthetic strain can thus be constituted which enjoys the nicking ability of the two *A* and *B* populations and half the initial heterosis. A synthetic strain can also be established from a variable number of strains or breeds: here three but also two or four. The members of the  $F_1$  generation are homogeneous but numerous genetic recombinations appear in  $F_2$ ,  $F_3$ , etc. These recombinations reveal a new genetic variability which can be used to create a pro-

ductive strain adapted to local conditions. In theory, to ensure that these recombinations appear fully, one would have to abstain from breeding for  $2n$  generations, where  $n$  is the number of strains used. In these examples  $2n=8$ . The number of strains will obviously rarely exceed three or four.

Parent animals from French, Italian or Spanish selection programmes can be chosen as the founder strains of these synthetic populations. This gives initial strains with good potential productivity and, through natural selection, the animals best adapted to local conditions. Two or three synthetic strains of this type can be created in a given country, in addition to any existing local strains. Cross-breeding experiments can then follow to compare these strains and choose a cross-breeding strategy for production.

#### Organizing genetic improvement: selection plans

This section uses an example to explain the organization of the technical components described throughout this chapter for a

genetic improvement plan. France will be used as a case-study for the questions that need to be asked.

*What is the initial situation?* France has a long tradition of rabbit meat production and consumption. The breeders are organized into producers' groups and again into a national federation, the FENALAP. Producers constitute one link in the chain with other groups working in the field, particularly feed and equipment manufacturers, breeders and slaughterhouses. This is an organized market with standard national rabbit meat grades. INRA has collaborated for 30 years with the *Institut technique de l'aviculture et des animaux de basse-cour* (ITAVI) building expertise and furthering rational rabbit production. Technical, economic and individual management systems can supply data on production performance. France also has more than 40 pure rabbit breeds, the product of the breeders' art.

*What kind of rabbit farming?* French rabbit production is a rational system with breeders producing meat for sale to slaughterhouses. The "model" rabbitry has 200 or more does, one or more specialized rabbit houses with wire-mesh cages and an automatic drinking system. Balanced pelleted feed is used. The breeder also buys improved breeding animals and follows a hygiene and preventive health-care plan. The rate of reproduction is intensive with mating in the first 12 days after kindling and weaning at four to five weeks. The rabbits are slaughtered at a weight of 2.2 to 2.4 kg and mostly sold as whole carcasses.

*What objectives?* The objectives are the rational outcome of the foregoing. The ideal rabbits are those adapted to rational production systems, i.e. a female weaning a large number of fairly heavy young which reach commercial weight quite quickly and a male rabbit that transmits good growth potential and carcass quality to his progeny. This simplified presentation is con-

finied to the principal objective, but there are secondary objectives for market diversification.

*What kind of organization?* France has chosen a pyramidal plan (Figure 20) to create, accumulate and disseminate genetic progress, much as in poultry production. Private companies select strains that are cross-bred to produce meat rabbits. The "female" strains are selected for fecundity; the "male" strains are selected for postweaning growth and carcass quality.

These private companies supervise multiplication networks which cross pure strains to produce the cross-bred female and the terminal-cross male, the parents of the meat rabbit.

Meat producers buy these improved breeding animals. Today, the "female" strain multiplication stage is often done in the production rabbitry. The breeder purchases the B grandparent male and the C grandparent female (Figure 21). Increasingly, one-day-old breeding animals are being purchased to be fostered by does with good maternal performance. These two techniques reduce the risk of transmitting health problems.

The main drawbacks are the health risk and the cumbersome organization. To obviate this risk, FENALAP and the breeders voluntarily adhere to a charter defining the rights and obligations of each partner. The main provisions of this charter include visits by a commission of experts every two years to selection and multiplication establishments and the utilization of technical and economic management by these enterprises, with FENALAP available to hear breeder complaints.

Within this pyramidal scheme, breeders create and build up genetic progress, which is then disseminated to and used by producers. A plan of this sort will not work unless the technical, economic and scientific organization described is in place.

FIGURE 20

*Pyramidal scheme for creating and disseminating genetic progress in rabbits*

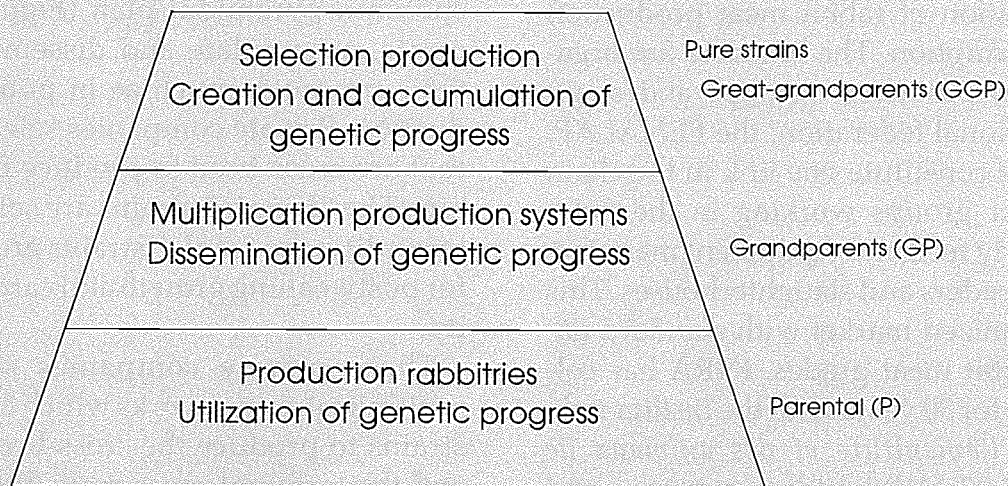

### **A country or regional review of the problem**

An initial hypothesis is that no approach can be transposed without prior reflection. The failures chalked up in recent years in various countries, not just for rabbits, are an illustration of this hypothesis. This review asks the following four questions:

*What is the initial situation?* Is there a rabbit production and/or consumption tradition? Are there rabbitries, local rabbit populations, imported populations? What are the techniques, rabbit housing and equipment and materials used by rabbit producers? What is the potential of existing populations? How should marketing be organized? Are there feed manufacturers, buildings and equipment, slaughterhouses, breeders and veterinarians with a background in rabbit production? Are there research, development and teaching organizations with an equal background? What is the government position on rabbit production? What role does it assign the rabbit in animal production?

*What type of rabbit breeding?* What is the breeder's objective: home consumption, export, sale to the local market? How big a

rabbitry? What type of housing, equipment, feed, breeding animals, health care? Which rate of reproduction? Weight and age at slaughter? Organization and training for breeders?

*Which selection objectives?* The answer is simple: a rabbit adapted to the above constraints.

*Which organization?* Group organization is preferable because it is more efficient. The pyramidal scheme with private breeders is just one solution among many, e.g. collectively managed production units. There are other strategies that are less hierarchical, less rigid and better adapted to local constraints. This question raises a whole list of further questions: who creates genetic progress? Is there a buildup of genetic progress? Who disseminates it? What about cross-breeding? Who finances the cost of selection and dissemination? Who is responsible for checking the health, adaptability and production level of the animals produced?

### **CONCLUSIONS**

Domestic rabbits are not as widespread as the other species of domestic mammals

FIGURE 21

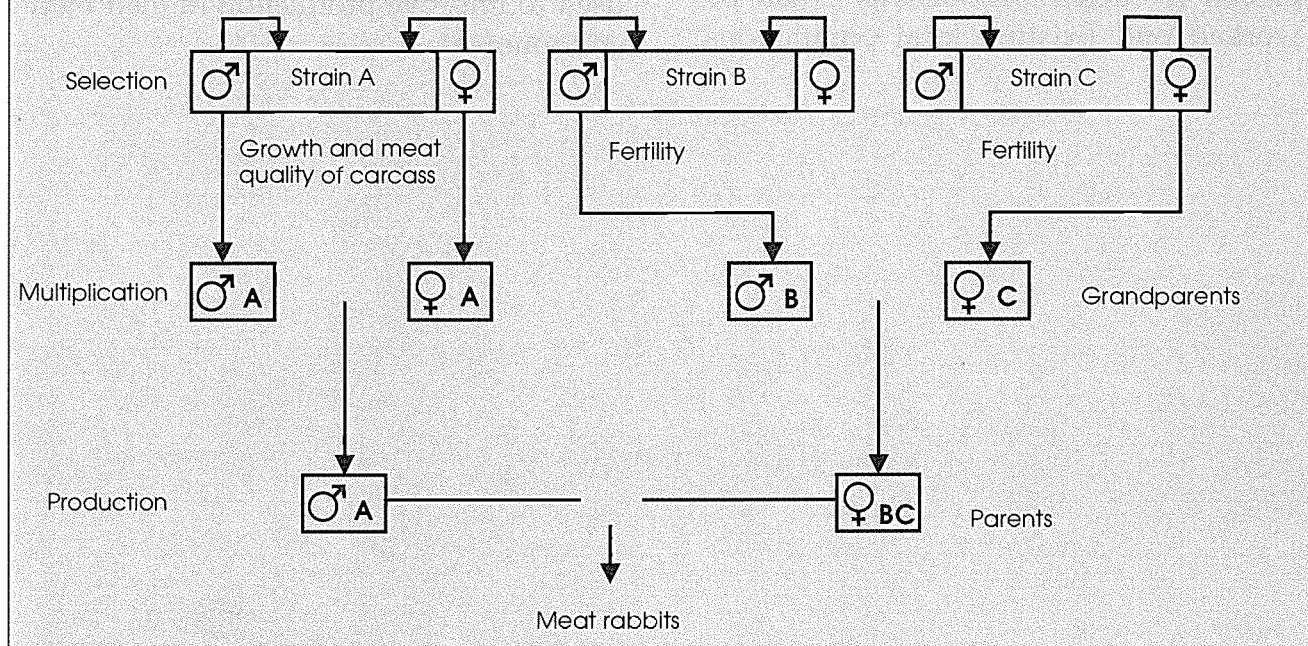
*Use of different strains in a pyramidal scheme*

that are traditionally used to provide meat, milk, wool and skins. But rabbits are genetically very flexible, which makes them adaptable and productive in a wide range of production systems.

Research on rabbit breeding behaviour and production development started only recently – less than 40 years ago – although formal genetic research has a longer history. For production and selection this can be both an advantage and a drawback. The advantage is that there is less temptation for countries to import ready-made solutions without examining their own specific problems. A relative drawback is that the newness of this field of research calls for a new and appropriate genetic improvement pattern for each region or country. The major constraint here is dependence on the environment and a careful study of the production environment is essential.

The great genetic flexibility of the species and its short life cycle are definite assets. This flexibility is a function of a genetic variability which can be traced to the recent domestication of the rabbit and the lack of intensive artificial selection. This has made

possible the rapid emergence of breeds varying greatly in adult size and muscle development (adult weight varies at a ratio of 1:8). Doe prolificacy depends basically on the breed. In breeds of comparable mature size, average prolificacy is relatively independent of the environment. This character can be turned to good account in deciding how to use local populations.

Various breeds and populations are available for developing or modernizing production. A minimum of environmental factors must be mastered first; for the rest the rabbit will simply adjust to the physical and human constraints of its habitat.

In most developing countries, highly intensive production with complete control over technical and environmental detail is precisely the opposite of what is needed. What is needed are careful country profiles of the production environment (technical studies of local feed resources and genetic and sociological studies) and training for rabbit breeders. For genetic improvement, the first step could be a study of the breeding performance of pure and crossed local populations. Local populations are usually

smaller in size and less prolific and appropriate crosses with local and imported breeds for better productivity could be worked out. Existing local populations

should always be conserved and selected on an intrapopulation basis so they can be used to improve production in their own environment.

## Chapter 5

# Pathology

### INTRODUCTION

It would be inappropriate here to insert a treatise on rabbit diseases. A disease cannot be described without reference to medical data with which the user of this book is in all likelihood not familiar. In addition, the pathogenic agents of many rabbit diseases are known and in some cases well described, but their presence does not necessarily imply the existence of a disease. Disease is almost always the result of poor husbandry and environment coupled with the onslaught of a pathogenic agent - microbe, virus or parasite.

This chapter therefore starts with a general discussion of the pathology of the rabbit before it goes into more detailed descriptions of the principal diseases.

### APPEARANCE AND DEVELOPMENT OF DISEASES

The animal has multiple and interlinking defences for countering attacks from the outside environment. These can be classified arbitrarily and briefly as:

- *non-specific defences*, which can be mobilized very rapidly or even instantly (such as adrenalin discharge), and which bring into play all the major body metabolisms (mobilization of sugars and fats), and all the major functions (blood circulation, breathing, etc.);
- *specific defences*, including immunity, which is how the organism recognizes a hostile foreign body (microbe, parasite, virus, protein) and sometimes, though not always, eliminates it.

The body does not have an infinite capacity for non-specific or specific defence. So the producer's main job is to rear the ani-

mal in conditions where it does not have to engage in a permanent struggle for survival.

When it does, the physiologically exhausted animal eventually can no longer defend itself and disease will break out – which disease will depend on the climate, the environment and the type of rabbitry. Not all animal species are equally sensitive to the same kinds of attack. The major known environmental conditions that are unfavourable to rabbit health are described later in this chapter.

The influence of germplasm is unquestionably one element in resistance or vulnerability to disease. In terms of species evolution, however, the rabbit was introduced outside the Mediterranean basin only fairly recently, and new European progenitors have constantly been reintroduced. The concept of “local breed” needs to be viewed with some circumspection.

### The environment

The environment is everything that surrounds the animal: its habitat, its congeners, its solid and liquid feed, microbial contamination, temperature, air and noise. The concept of environment can be extended to the farm, village, region and even the country. How far the environment extends is no longer an abstract concept when the number of animals per square metre, hectare or square kilometre grows without a parallel upgrading of hygiene and health standards. An infinity of examples for every species of plant and animal shows that the larger a population grows, the more it becomes imperative that rules of hygiene be respected.

A point that agricultural officials have all too often ignored is that this basic notion is as true at the production-unit level as it is at the village, region or country level. In traditional French rabbitries, for example, pasteurellosis was once a lethal respiratory disease that could decimate the rabbit population of a whole village within a few weeks. Today, the drop in the numbers of these traditional units has led to a marked reduction in the epizootic and lethal properties of this disease.

Myxomatosis decimated the rabbit population in Western Europe in a few months, not only because the virus had been introduced but mainly because the environment as a whole was favourable; the main factor was the overpopulation of wild and domestic rabbits in France at that time. An increase in the number of large rabbitries, combined with expanded trading in France, Spain and Italy, fostered the appearance and simultaneous spread throughout these three countries of three hitherto sporadic diseases: dermatomycosis, staphylococcosis and colibacilli O103.

#### Microbial contamination

Microflora is also a component of the environment. This chapter devotes special attention to microbial contaminations because they are a major, inevitable form of attack in all rabbitries.

Microbial contamination refers to the polluting of air, objects and soil by bacteria, parasites, viruses or fungi. Most often, these microscopic organisms are not intrinsically pathogenic. They become pathogenic when pollution reaches a high, continuous threshold. Ambient microflora is present from the start of production in a unit and inevitably expands as time goes by. One of the breeder's basic tasks is to slow this inevitable increase as much as possible. This is done by respecting the rules of hygiene and by limiting stock to the number of animals that can be maintained and nourished properly.

A small, properly run rabbitry is more productive in the long term than a large one that is poorly run. It is also less of a menace to neighbouring rabbitries.

Farmers everywhere know how important and beneficial fallow periods and crop rotation are for the soil they till. One reason these methods are so beneficial is that they reduce local microbial infections specific to each crop. Plant species, like animal species, are each surrounded by their own microbial environment. No matter how capable a breeder is, the day will come when the rabbitry will have to be cleared, thoroughly cleaned and disinfected in order to lower ambient microbial contamination to a safe level.

#### Rabbitry management

Management (husbandry) is also part of the production-unit environment, but the impact of management on disease is often forgotten. The way breeding and husbandry methods have evolved in different countries shows that any method can have both positive and negative consequences. Age at weaning is undoubtedly the most important variable. Weaning at 28 days does limit or even eliminate the transmission of certain disease agents, such as *Pasteurella* and *Escherichia coli*, but stopping the mother's milk somewhat curtails the passive immunity of young rabbits and unquestionably favours *E. coli*. Weaning much later wears out the dams. Intensified production has led some breeders to opt for a highly accelerated mating calendar (mating following kindling the same day) or for moving the females very often. These choices mean a shorter life for breeding females. Raising rabbits in groups, as is done in the big European producer countries, considerably modifies rabbit pathology.

Breeders need to remind themselves, in deciding how to manage their stock, that the theoretical advantages they see may be



accompanied by disease repercussions. As for pathologists, they will need to consider the production methods and not simply the disease agents and symptoms they have identified. Health-care interventions are contingent upon knowledge of these methods.

### Conclusion

It would be wrong to think that the following sections will do more than elaborate on the foregoing, for the heart of the matter has already been discussed. The producer's best ally for healthy rabbits is the animals' own capacity to ward off disease. An organism's defence against outside attacks is basically a global, non-specific response which is fundamentally dependent on good hygiene standards in the rabbitry. The rules of hygiene are easier to apply and to respect in small rabbitries with simple equipment that is easy to maintain. Daily preventive cleaning will keep the contamination and pollution levels down and make the rabbitry viable and productive for a longer period. Preventive hygiene is the key to a clean, well-run rabbitry in which the producer can more effectively control any disease which might break out.

### INTESTINAL DISEASES

This chapter will deal with disease not as a function of the pathogenic agents specific to the rabbit, but as a function of syndromes or combinations of disease manifestations which share common or closely related symptoms and are important in economic terms. Unquestionably, intestinal diseases are most costly to rabbit breeders and the major obstacle to expanded rabbit production. Diarrhoea is a serious economic threat, primarily in young weaned rabbits (four to 10 weeks). It is rare before weaning and can in any case easily be prevented by elementary sanitary and feeding hygiene. It should be noted that diarrhoea appears later in young rabbits than in other young domes-

tic mammals such as piglets, calves, lambs or even young hares. Among these species diarrhoea strikes in the very first days after birth. The fact that young rabbits do not suffer from neonatal diarrhoea is probably due to their being born hairless and blind, and thus confined for weeks to their nests, sheltered from outside attacks. Diarrhoea is also rare among adult rabbits. It is usually the final consequence of some other ailment.

The first point to make clear is that the rabbit's reaction to disease, whatever the nature of the attack, takes the form of intestinal disturbance, which nearly always expresses itself as diarrhoea. This response can be traced to several features peculiar to the rabbit.

The first has to do with a rabbit's mental reactions. The rabbit is an excitable animal. Its relatively recent domestication has undoubtedly not yet conditioned it to adjust its alarm reactions (discharge of adrenalin) according to the gravity of the attack.

The second peculiarity is the complexity of the rabbit's intestinal physiology. Caecotrophy is one manifestation of this. The hormone reactions governing the alarm reaction directly affect the nervous system of the intestine, halting or slowing peristalsis, which slows the passage of food through the intestine and halts caecotrophy.

A third feature of the rabbit's post-attack reactions is the alkalinization of the contents of the caecum. The increased pH is linked with the slowed passage of food which modifies the intestinal environment, particularly the flora. *Escherichia coli*, usually few in the healthy rabbit, become dominant. The fact that the soft pellets are no longer ingested also helps to modify the intestinal milieu, particularly the volatile fatty acid balance.

The last peculiar feature of the rabbit is that the appearance of clinical symptoms is delayed after an attack. In animal species that seem to be very excitable (pigs, horses)

the symptoms appear most often within a few hours (ulcer, colic, diarrhoea). In the rabbit, an ordinary change of habitat, a scare or a journey have no immediate consequences. Diarrhoea appears only some five to seven days afterwards.

#### **General symptoms of digestive problems**

The symptomatology of rabbit enteritis is relatively simple and constant and rarely permits an aetiological diagnosis of the disease. The first signs, scarcely noticed by the breeder, last one to three days, and take the form of a decrease in feed intake (especially solid feed) and in growth. Next, diarrhoea appears, sometimes preceded by complete constipation or production of soft pellets which are not eaten.

Diarrhoea is moderate, consisting of a small quantity of fairly liquid faeces which soil the animal's hindquarters. Death can occur at this stage, sometimes even before the appearance of diarrhoea. Skin dehydration also appears at this time.

Two or three days later the acute phase of the illness starts. It involves an almost total stop in both solid and liquid intake, extensive diarrhoea and high mortality; grinding of the teeth is a symptom of severe intestinal pain. Death follows after several hours of agitated coma with spasmodic twitching. If the animal survives a full day in coma it may recover fully within a few days.

Recovery is in fact remarkably swift. Diarrhoea often gives way to constipation. The pellets are small, hard and malformed. In a rabbit two or three months old, the constipation phase is often the only symptom. Physiologically, however, diarrhoea will have occurred and can be perceived by palpating the abdomen: during the acute phase the breeder can feel that the caecum contents are liquid.

A post-mortem examination shows lesions, usually atypical. During the acute phase the intestinal contents are very liq-

uid, sometimes discoloured. The caecum often fills with gas and contains little food matter.

The intestine is sometimes congested or bruised. The walls of the caecum are most striking, congested and streaked with red, like brush strokes. The colon may be filled with a translucent jelly. There will usually be no fibrin in the abdominal cavity, an indication of the acute stage of this disease.

#### **Causes**

*Non-specific causes.* It has been seen that very different factors can cause outbreaks of diarrhoea. Rabbits seem to react negatively to: transport, especially during the postweaning period; being put in a new hutch or cage; the presence of unusual visitors (people or animals); and sounds not identifiable by the animal and lasting for hours or days, such as work in progress near the rabbitry.

Feeding is unquestionably a prime factor in the occurrence of diarrhoea. Not enough crude fibre, too much protein and meal which has been too finely ground are all unfavourable. Also to be remembered is the fact that the rabbit regulates its intake according to the energy in the feed. Too much energy in the feed can lower the intake too far and vice versa. These are all factors which can favour the onset of intestinal problems. Feed changes are all too often blamed for diarrhoea. Even when feed is the obvious cause, more often the problem is the composition of the feed rather than the change itself. On the other hand, when the animals do not always have good feed available, at least the daily timetable of feeding should be respected. There have been many instances of diarrhoea "epidemics" in rabbitries where a change in timetable was the suspected culprit. This is easily explained by the rabbit's complex intestinal physiology (caecotrophy).

Improper watering is very common in farm rabbitries. It is probably one of the major causes of mucoid enteritis. Rabbits must have clean water available at all times.

It is worth repeating here that the non-specific causes favouring the appearance of diarrhoea can be defined as anything which forces the animal to spend too much time defending itself against its surroundings.

*Specific causes.* Theoretically, these include any cause which, alone, allows the disease to manifest itself. In fact, the state of health is almost always the main factor.

*Chemical agents.* Administration of some antibiotics invariably provokes diarrhoea: ampicillin, lyncomycin and clyndamycin. Antibiotics should always be used very sparingly with rabbits, especially penicillin. It also seems that drinking-water with a high nitrate content causes the chronic diarrhoea observed in some areas.

*Mouldy feed* (pellets, domestic waste, bread, vegetable peels) can very quickly cause diarrhoea even in a healthy rabbit.

*Viruses and bacteria.* There has been little work on enteropathogenic rabbit viruses but they are known to exist. It is very likely, however, that as with most other animal species the condition of the animal itself is a decisive factor in the occurrence of viral diarrhoea. The presence of rotaviruses is a good example of the important role of management. These viruses appear in group rearing (all animals in the rabbitry being the same age), with weaning at 35 days (suppression of passive immunity) and after the animals have been grouped (stress) at 42 days.

Much the same is true of bacteria. *Salmonella* are rarely isolated in sick rabbits but this is not true of *Corynebacteria*, *Clostridium*, *Pasteurella* and, especially, *Escherichia coli*. Apart from some *Clostridium* species and a few serotypes of *E. coli*, healthy rabbits carrying these bacteria do not contract the

relevant disease. Nevertheless they must be regarded as specific pathogenic agents even if they express their pathogenicity only in a random manner. For example:

- the most pathogenic among them (*Clostridium*, certain serotypes of *E. coli*) can, above a certain pollution threshold in the rabbitry, be the direct cause of diarrhoea and its persistence;
- very often, if not always, they constitute a secondary complication of enteritis which, although not serious at the outset, does become serious and then lethal;
- with both *Clostridium* and *E. coli*, pathogenicity depends in part on toxins which rapidly provoke irreversible and incurable lesions.

*Intestinal parasites.* All the major parasite families are found in rabbits: trematodes (flukes), cestodes (tapeworms), nematodes (intestinal worms) and protozoa (coccidia). Coccidia are the major specific agents of diarrhoea in the rabbit. In view of their importance the following section is concerned solely with them. The other parasitic diseases will be dealt with as a whole after coccidiosis and bacterial enteritis.

#### Coccidia and coccidiosis

*Coccidia.* Coccidia are protozoa, the most primitive phylum of the animal kingdom. They are sporozoa, i.e. parasites with no cilia and no flagella, which reproduce both sexually and asexually. A large number of families are represented. The Eimeriidae family is typified by the independent development of male and female gametes.

Almost all coccidia belong to the genus *Eimeria* – they include four sporocysts containing two sporozoites. Typically they form oocysts, a parasite mechanism for dispersal and defence in an external environment.

*The coccidia cycle.* *Eimeria* are monoxenous and have very high host specificity. The rabbit therefore cannot be infested by the

coccidia of other animal species, nor can they be infested by rabbit coccidia. *Eimeria* develop in the epithelial cells of the digestive apparatus (intestine, liver). Eggs (oocysts) are found in the intestine and faeces. After maturing (sporulation), the oocysts contain eight "embryos" (sporozoites).

The *Eimeria* cycle includes two distinct phases:

- an internal phase (schizogony + gamogony) in which the parasite multiplies and the oocysts are eliminated in the faeces;
- an external phase (sporogony) during which the oocyst becomes able to infest if it finds favourable conditions of humidity, heat and oxygenation.

The internal part of the cycle begins with ingestion of the sporulated oocyst and the excretion of the sporozoites. The parasite then multiplies. This may entail one, two or more schizogonies (asexual reproduction) according to the species (*E. media*, two schizogonies; *E. irresidua*, three or four schizogonies). It can take place in different parts of the digestive system (*E. stiedai* in the liver; *E. magna* in the small intestine; *E. flavescens* in the caecum). The final schizogony leads to the formation of gametes.

The next step, gamogony (sexual reproduction), ends in the formation of oocysts that are excreted with the faeces; the total duration of the internal phase of the cycle also varies with the species (e.g. *E. stiedai*, 14 days; *E. perforans*, four days).

The external part of the cycle (sporogony) is typified by the extraordinary resistance of the oocysts to the outside environment. Their resistance to chemical agents is particularly striking. In the right conditions of humidity, heat and oxygenation the oocysts become able to infest. They sporulate. Hatching time varies: at 26°C, *E. stiedai* takes three days and *E. perforans* one day.

Coudert (1981) in France and many others have studied this part of the cycle, as the

oocyst is the agent to be destroyed. In practice, oocyst resistance is hard to overcome, particularly in disinfecting rabbitries. Chemical disinfection is pointless as oocysts can only be destroyed by heating and drying.

*Species.* At least 11 coccidia species are rabbit parasites. One infests the liver, the other ten the intestine.

- *Eimeria stiedai*, the liver coccidiosis, causes no economic losses in Europe except at the slaughterhouse. It is relatively easy to eliminate this parasitosis by a few weeks of very strict health and hygiene measures and preventive medicine. A four- to six-week treatment with conventional anticoccidia products (Decox, Pancoxin, forinosulfathiazole) in the feed at preventive doses virtually eliminates the disease. In climates less clement than Europe's and in countries where it is not so easy to get the right medicines, liver coccidiosis can have more serious consequences. As the liver is an organ basic to every process involving homeostasis, chronic liver attacks cannot fail to diminish the animal's resistance capacity.

Intestinal coccidia can be classified in four categories (Table 48):

- *Eimeria coecicola* and *E. exigua* are apathogenic. No clinical sign is detectable even with an inoculum containing several million oocysts.
- *E. perforans* is very slightly pathogenic. Alone, it never causes diarrhoea or mortality. Massive infestations ( $10^6$  oocysts) are needed before there is a slight and very brief decrease in growth.
- *E. irresidua*, *E. magna*, *E. media* and *E. piriformis* are pathogenic species that cause diarrhoea and growth retardation of as much as 15 to 20 percent of live weight for infestations with between  $0.5$  and  $1 \times 10^5$  oocysts. When they occur alone these coccidia are not usually lethal, even in a relatively heavy infestation.

TABLE 48  
Comparative pathogenic strengths of different intestinal coccidia of the rabbit

Pathogenicity	<i>Eimeria</i>	Symptoms
Non-pathogenic or slightly pathogenic	<i>E. coecicola</i> <i>E. exigua</i> <i>E. perforans</i> <i>E. vej dovskyi</i>	No sign of disease or slight drop in DWG No diarrhoea
Pathogenic	<i>E. media</i> <i>E. magna</i> <i>E. irresidua</i> <i>E. piriformis</i>	Drop in DWG Diarrhoea Little or no mortality
Very pathogenic	<i>E. intestinalis</i> <i>E. flavescens</i>	Severe drop in DWG Considerable diarrhoea High mortality

Note: DWG = daily live-weight gain.

- *E. intestinalis* and *E. flavescens* are the most pathogenic coccidia. They cause diarrhoea and mortality, even at very low dose rates (upwards of  $10^3$  oocysts).

#### Observations

Pathogenic effect has been judged here solely on the basis of retarded growth and mortality. But it must not be forgotten that coccidiosis, like all diseases, can have certain after-effects on the kidneys or liver in particular, which in turn have repercussions on fattening status at slaughter or on the animal's future if it is to be kept as a breeding animal.

Often one disease is also complicated by other diseases. In fact, the above results were obtained with rabbits reared under especially favourable conditions, which means there were practically no bacterial side-infections. It is not known, for example, whether in an unfavourable environment coccidia of the second group (*E. media*, etc.) might not have a more severe impact.

**Lesions.** There are two kinds of lesions: macroscopic and histological.

- *Macroscopic.* Every coccidium has a preferential place to develop where it causes a reaction of the intestinal epithelium varying in visibility according to the bac-

terial species. The duodenum and the jejunum are parasitized by *E. perforans*, *E. media* and *E. irresidua*. The latter species is the only one which, at high concentrations, causes macroscopic lesions visible at autopsy. *E. magna*, *E. vej dovskyi* and *E. intestinalis* multiply in the ileum. *E. intestinalis* causes the most spectacular macroscopic lesions. The ileum becomes bruised and whitens; segmentation appears very clearly, especially in the part nearest the caecum. The appearance of the lesions is the same with high concentrations of *E. magna*. The caecum is the domain of *E. flavescens*, which at medium dose levels produces lesions on the colon. The caecum wall thickens and changes appearance according to whether there is microbial infection or not. It may look whitish in heavy infestations with no complications, but very frequently reddish striations, necrotic plaques or generalized congestion appear. The most constant factor is the emptiness of the caecum. Lesions can be caused in the colon by *E. flavescens* and above all by *E. piriformis*, the only rabbit coccidium capable of causing enterorrhagia in the *Fusus coli* at medium dose levels (30 000 to 50 000 oocysts).

- *Histological.* There are two points to stress here: lesions, both macroscopic and histological, are relatively short-lived. They appear towards the eighth or ninth day and disappear by the 12th or 13th day, despite their sometimes spectacular appearance (*E. intestinalis*, *E. flavescens* and *E. piriformis*). Histologically, hypertrophy can only be observed in the epithelial cells of the intestine. Cell structure remains intact. Moreover, the number of cells parasitized is extremely low in proportion to the number of cells of the epithelium, but all the cells, whether parasitized or not, look the same. Only a few cell clusters deep in the crypts of Lieberkühn will be destroyed.

**Coccidiosis.** Coccidia are specific pathogenic agents. When inoculated into rabbits pathogenic coccidia cause the same lesions and the same symptoms (diarrhoea, loss of weight, death) in all the animals tested.

*Clinical signs.* Most of these are not specific to intestinal coccidiosis. The main symptoms are: diarrhoea, weight loss, low intake of feed and water, contagion and death.

The clinical evolution of an intestinal coccidiosis is illustrated in Figure 22.

Depending on the coccidia species, diarrhoea appears between the fourth and the sixth day after infestation. The peak is from the eighth to the tenth day. It then declines in three or four days. Diarrhoea is the first visible symptom, together with cutaneous dehydration, clinically demonstrated by the persistence of skin folds.

Weight gain and feed intake evolve in a sequence that faithfully follows the evolution of the diarrhoea. For two or three days growth and feed intake are low. Between the seventh and tenth day after infestation there is weight loss, perhaps as much as 20 percent of live weight in two or three days. Recovery is equally rapid. Two weeks after

inoculation the animals may resume their initial growth.

Mortality occurs during a relatively short period (three or four days), starting abruptly on the ninth day after infestation.

The intensity of these general symptoms naturally varies according to the *Eimeria* species involved (see above), the degree of infestation and the animal's general condition. Identical effects can be obtained by using different dose levels of different species of *Eimeria*.

Few data are available on simultaneous infestations, but there appears to be no synergistic action among the various species except with *E. piriformis*, which seems to augment considerably the pathogenicity of other species. This is rather easily explained by its locus of implantation and the fundamental role of the colon (see physiopathology, below).

It is common for bacterial flora to develop at the same time as coccidiosis, complicating and aggravating the symptoms of the disease.

If there has been no contact with coccidia (non-immune rabbits), then age is not a major factor in susceptibility in rabbits. The disease is briefer in animals 10 to 11 weeks old and diarrhoea less severe, but weight loss and mortality are often more pronounced than in younger rabbits. However, the early contact does confer relative immunity.

*Physiopathology of diarrhoea of coccidian origin.* The main symptom of intestinal disease in young rabbits is diarrhoea. Rabbit enteritis following coccidiosis has been studied with reference to calves and human infants, in whom episodes of diarrhoea are essentially linked with hydromineral perturbations. In calves and infants diarrhoea seems to be dominated by three main phenomena. There is, of course, considerable loss of faecal matter. The usual impact on the metabolism is extracellular dehydration and metabolic

FIGURE 22

The clinical evolution of coccidiosis

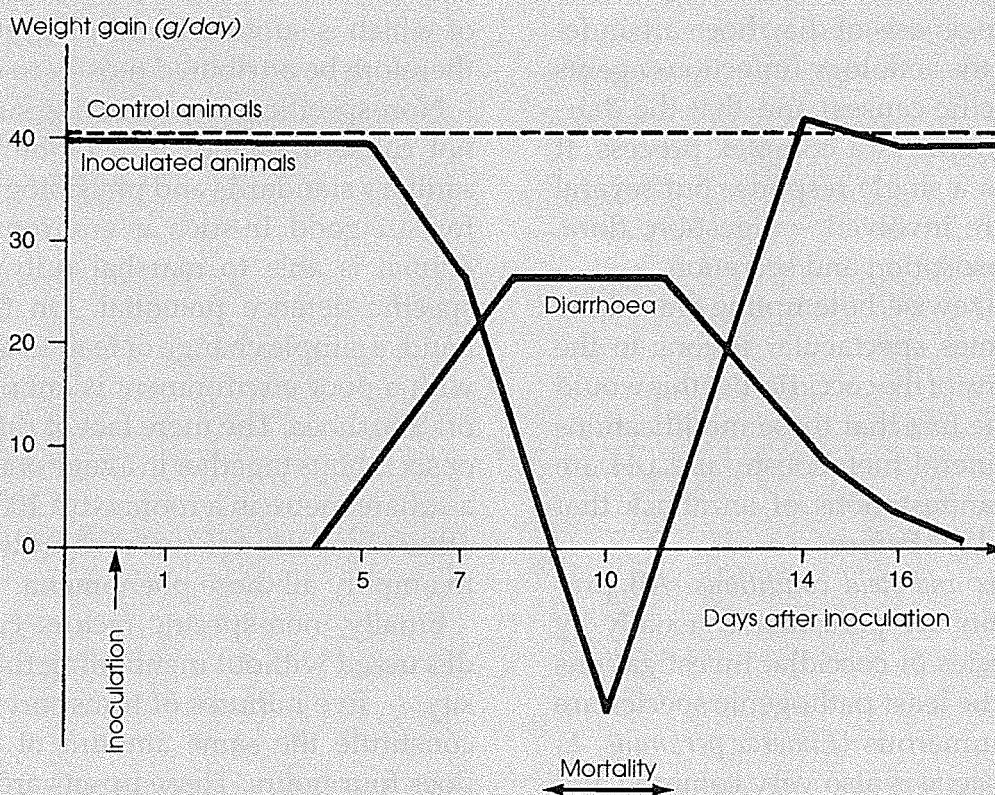

acidosis. Rabbits suffering from diarrhoea, like calves and infants, certainly have more watery faeces, but sick animals produce a smaller quantity of faeces than healthy ones. Calves and infants urinate little or not at all with diarrhoea and there is haemoconcentration associated with extracellular dehydration. In young rabbits, diuresis is not altered during diarrhoea and there is haemodilution. The distribution of water in the organism is unmodified except that the skin is heavily dehydrated. Blood pH is normal. The most marked modification of the blood plasma is severe hypokalemia.

The pathogenesis of diarrhoea in the young rabbit thus appears to differ from the more conventional diarrhoea of the calf or infant, but the prime mover at the intestinal level seems to be common to all. In

diarrhoea of calves due to *E. coli*, for example, the small intestine secretes water and minerals, especially sodium, which will be lost by the animals.

In the young rabbit there is also a lack of reabsorption – indeed an actual secretion – of sodium and water in the loci where the parasites multiply. Unlike calves, however, rabbits can compensate for these disturbances in the distal colon and, most important, they can initiate a Na-K exchange which limits sodium losses to a minimum. Potassium losses are replaced from body reserves. These parameters evolve at the same time as the symptoms described earlier. Peak intensity of symptoms occurs at about the tenth day after infestation. Certain elements are generally described as constants in rabbit enteritis: lengthening of the retention time of the

ingesta in the intestine, high levels of colibacilli and intestinal pH tending towards basicity.

This suggests that the basic phenomena of the pathogenesis of diarrhoea are independent of the aetiology (infectious agents or non-specific causes) and that the diarrhoea syndrome is a complex process. It may lead to a single response but several elements are involved – digestion, flora, motility, absorption and secretion.

It could, likewise, be tempting to attribute the sometimes spectacular lesions to the pathogenicity of the coccidia. But this would overlook the fact that these modifications in hydromineral metabolism and pH are delayed manifestations of an attack that took place days before.

*Coccidiosis and field conditions.* All production units are parasitized, usually by several species of coccidia. Investigations show that the least pathogenic species are the most numerous (*Eimeria perforans*, *E. media*). *E. magna* is also very common and often found in great numbers. *E. intestinalis*, *E. flavescens* and *E. irresidua* are less common. This is a good thing, because their mere presence is a real menace to the rabbitry. *E. piriformis* is rare in Europe and *E. intestinalis* has not been identified in Benin.

It must not be forgotten that a single pellet from a healthy rabbit raised in a sound, clean rabbitry usually contains enough coccidia to cause diarrhoea if the same number were inoculated into the animal. Yet not all rabbits contract clinical coccidiosis. It almost always depends on conditions in the rabbitry. If conditions are good only a few animals will die of diarrhoea. If conditions are bad there will be a chronic mortality rate of 10 to 15 percent. Indeed, this is the usual situation.

Whether the environment is good or bad, any stress can set off coccidiosis, whatever the animal's age. It is curious to note that diarrhoea strikes not only young, newly weaned rabbits, but also older animals

which have been in contact with the parasites for several weeks. Naturally acquired specific immunity is always very weak.

The outbreak of coccidiosis, the progress of which is summarized in Figure 23, can therefore be attributed mostly to stress.

Non-specific stress occurring singly cannot cause diarrhoea in a rabbitry where sanitary standards and physiological comfort are good. In such an environment the animal is able to marshal fully its non-specific defence potential. On the other hand, a simple change of feed in a rabbitry with a poor environment is enough to set off diarrhoea. The mere fact of raising five or six rabbits together in a cage one-third of a square metre in a room with 100 or 1 000 other cages acts as a sort of sounding board to amplify all these phenomena.

Finally, non-specific factors cannot be discussed without mentioning their intensity – five minutes of transport does not constitute the same amount of stress as does four hours. These upsets are the root cause of outbreaks and it is only later, in most cases, that specific disease agents intervene (viruses, bacteria, coccidia). Each agent, merely by its permanent presence at low or average level, can also help undermine the rabbit's defence mechanisms without there necessarily being any permanent clinical disease.

The same is true of the other specific chronic diseases such as respiratory ailments and myxomatosis which by the very process of sapping the organism's defence capacities will become the indirect agents of outbreaks of coccidiosis and diarrhoea. Cases of primary coccidiosis are therefore probably rare. They can nevertheless occur, in particular when animals which are carriers of pathogenic species are introduced to the rabbitry.

*Diagnosis.* Coccidiosis is often extremely difficult to diagnose. It can only be done in the laboratory, by counting coccidia per gram of excrement and examining the



FIGURE 23  
Development of coccidiosis

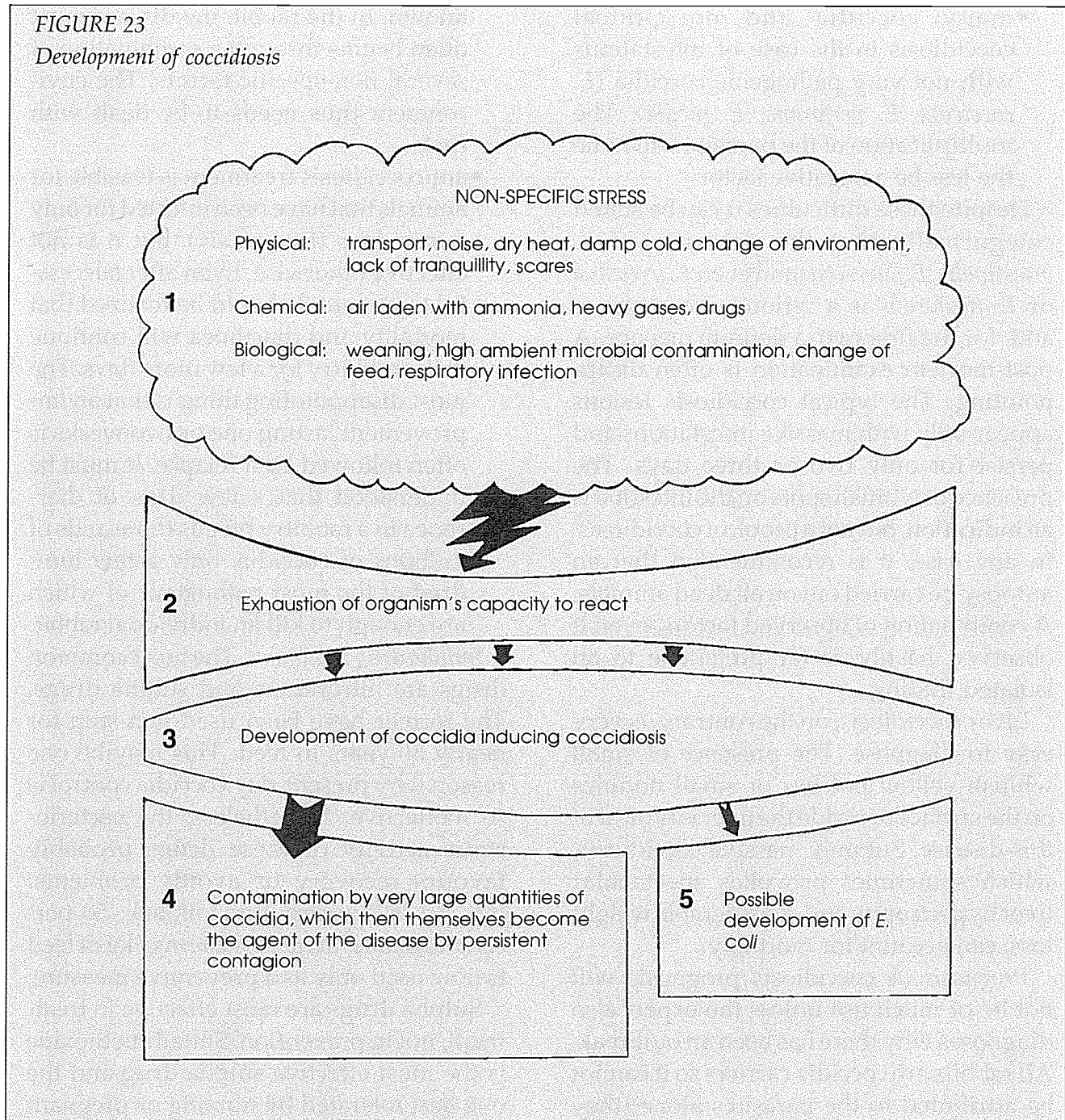

viscera. Counts must be made on several animals for several days running to diagnose coccidiosis properly. The specific coccidia species and their pathogenic potential also need to be identified.

For coproscopic investigations, examination of excreta several days old taken from under a cage where there are several animals is preferable to and far more reliable than a caecum contents examination. At any given moment (death or slaughter

of the animal) there may be:

- no trace of coccidia and coccidiosis: this is the not uncommon case in animals that die before the completion of the coccidial cycle;
- few coccidia and little coccidiosis: as above, with mortality occurring a little later. This happens mainly with very pathogenic coccidia which kill rapidly (*E. intestinalis*, *E. flavescens*) even at low concentrations;

- many coccidia and no clinical coccidiosis in the case of infestations with not very pathogenic coccidia (*E. coecicola*, *E. perforans*, *E. media*). The multiplication of the parasite will none the less be a negative factor.

Despite these difficulties it can be stated categorically that the presence of *E. intestinalis*, *E. flavescens* and even *E. irresidua* or *E. piriformis* is a serious circumstance and, for the first two, a definite menace. A post-mortem examination is often disappointing. The typical coccidiosis lesions appear only with massive infestations and persist for only two or three days. The presence of whitish spots on the intestine is an indication, but not a proof, of coccidiosis. In any case, it is recommended that an autopsy be carried out on all dead animals. A combination of observed factors, even if observed hastily, is far preferable to an isolated finding.

Liver coccidiosis, on the contrary, is very easy to diagnose. The presence of small whitish-yellow patches or small nodules on the surface or inside the liver is typical of this disease. But only massive coccidiosis, which sometimes provokes spectacular liver hypertrophy and considerable weight loss, can account for mortality.

**Prognosis.** A coccidiosis prognosis will not be of much use unless the expert also diagnoses why there has been an outbreak. All rabbits are coccidia carriers so it cannot be attributed to the parasites alone (they were already present). Conditions in the rabbitry and the animals' resistance being such as to produce a multiplication of *Eimeria*, the environment must also be examined and treated. This is why the prognosis is often quite bleak.

**Control.** Treatment is often disappointing and always expensive. There are basically two reasons for this:

- medical treatment is not really appropriate unless the cause of the disease is

known. In the rabbit, the disease most often begins through a combination of several non-specific factors. The environment thus needs to be dealt with first;

- anticoccidiosis treatment is feasible for animals that have been infected for only a few days (five or six), but it is not effective otherwise. Even after successful treatment it should be realized that mortality and diarrhoea will continue in the rabbitry for a few more days. The most disappointing thing is that an improvement lasting one or two weeks is often followed by a relapse. It must be understood that a few days of diarrhoea in a rabbitry breeds thousands of millions of coccidia, only a few hundred of the most pathogenic of which are enough to kill an individual rabbit.

**Sulpha drug treatment.** The most common drugs are nitrofurans and sulpha drugs. The former have been used non-stop for nearly 30 years in feed. This may be one reason why present-day coccidia control is so ineffective. Nonetheless, the bacteriostatic activity of these drugs probably favours recovery or avoids problems. Bifuran (50 percent furazolidane, 50 percent furoxone) at rates of 200 mg/kg of feed is now used only as a preventive measure.

Sulpha drugs are most effective in treatment, not in prevention. Sulfadimethoxine is the most effective sulpha drug and the one best tolerated by nursing or pregnant does:

- curative dose: 0.5 to 0.7 g/litre drinking-water;
- preventive dose: 0.25 g/litre drinking-water.

The bacteriostatic activity of this drug, especially on pasteurellosis, makes it one of the best rabbit medicines. It should not be overused.

Sulfaquinoxaline is commonly used, but at higher doses:

- curative dose: 1 g/litre drinking-water;

- preventive dose: 0.50 g/litre drinking-water.

Sulfadimerazine, at 2 g/litre, is less effective.

These sulpha drugs can be boosted by antifolics, such as pyrimethamine or diaveridine, which allows the dose to be reduced considerably, but this increases their toxicity, especially for pregnant does. The use of sulpha drugs for pregnant does must be systematically avoided.

Formosulfathiazole is another excellent coccidiostatic drug at rates of 0.5 to 0.8 g/kg of feed as a curative measure, or 0.3 to 0.5 g/kg as a preventive measure. Unfortunately it is not water-soluble.

Curative treatments should always be applied to all growing animals for four or five consecutive days followed by a therapeutic rest. Treatment is then resumed for a further four or five days. If the medicine is given in the drinking-water care must be taken that the water is constantly clear. Where animals are fed watery forage such as roots and greens, these should be replaced by dry feeds or the animals will not drink enough water. Drug concentrations as generally indicated correspond roughly to a water intake of 100 to 150 g water per kg of live weight. When water intake exceeds this normal quantity (nursing does, very hot weather) the drug should be further diluted. Stepping up the concentration is not really possible – the rabbit would then probably refuse to drink the water.

*Treatment with antibiotics.* Antibiotics do not cure coccidiosis. They may, however, be used in cases of persistent diarrhoea or to prevent secondary bacterial complications. The most common antibiotics used for rabbits are neomycin (0.1 to 0.4 g/litre of drinking-water), colimycin (3 to 4.10<sup>5</sup> IU/litre) and the tetracycline group (0.2 to 0.3 g/litre). Once treatment with antibiotics is started it must be continued for three or four days at steady doses if it is to have any chance of being effective.

Antibiotics must be used cautiously in treating rabbits. Some that basically act on gram-positive flora are toxic to rabbits (ampicillin, lincosamin, clindamycin), while others should not be administered orally (chloramphenicol, penicillin, erythromycin, tylosin). With the possible exception of neomycin and the tetracyclines, antibiotics always entail the risk of digestive troubles.

In treating undiagnosed diarrhoea the proper treatment of coccidia alone is often enough to reverse the situation. Many French and other authors stress the importance of intestinal coccidiosis as a factor in the outbreak of enteritis and the benefit of treating coccidia. It should be remembered that giving medicine is not in itself sufficient treatment.

*Prevention.* Non-specific attacks and coccidiosis are the basic causes of diarrhoea. Diarrhoea prevention therefore consists of controlling these two factors. Good hygiene is the proper way to prevent the first. Preventive medicine should be added to combat coccidiosis.

There are two kinds of preventive medicine: vaccination and chemopreventive treatment. There is no anticoccidiosis vaccine (as of 1996). Active research is ongoing and hopefully short-cycle attenuated strains may soon be seen (early strains). Doses of sulpha drugs (see preceding pages) given to the young rabbits at weaning for eight to ten days are a good preventive measure in problem rabbitries.

Anticoccidial drugs administered as a preventive measure in balanced pelleted feeds are without doubt the most popular control method. A certain number of products can be used for rabbits (Figure 20). Robenidine has been used as a food additive in Europe since 1982 (66 mg/kg) and is very effective and well tolerated by rabbits. But ten years of use in the region have produced chemoresistance (*E. media* and *E. magna*). Others are effective (Lerbek) or

highly effective (Salinomycin, Diclazuril, Toltrazuril-hydrosoluble), but had not been used for rabbits as of 1993. Anticoccidial products of the ionophore family used in poultry husbandry are usually very toxic to rabbits: Narasin, Monensin, Maduramycin. Some are well tolerated (Salinomycin 20 ppm; Lasalocid 50 ppm), but overdosage must be avoided. Anticoccidial products much in use in poultry husbandry, such as Amprolium and Coudert (methylchlorpindol), have little, if any, effect on rabbits. Coudert (1981) has made an exhaustive bibliographic review of these products. The disadvantage of such drugs is that they are not water-soluble, which means they can only be administered in balanced pelleted feeds. Antibiotics added to feed in constant low doses are strongly warned against as ineffective and dangerous.

Preventive hygiene is the keystone of coccidiosis control and successful rabbit production. It is far more important than any other anticoccidiosis measures and for this reason the last section of this chapter deals solely with preventive hygiene.

Acquired immunity to coccidia is species-specific. Coccidia cannot develop in young rabbits before 21 to 25 days, i.e. while lactation is the principal source of nourishment. The presence of coccidia before the age of 28 days is a sign of insufficient milk or poor hygiene. After weaning, in the presence of contamination, immunity is acquired in 10 to 12 days and lasts to adulthood. Acquired resistance is weakened, however, by the immunodepressive effect of major stress.

#### Bacterial enteritis

Apart from coccidiosis there are two other classic types of rabbit diarrhoea. Renault (1975) has published a detailed description of the mechanism of these diseases.

*Mucoid enteritis.* A special kind of diarrhoea sometimes affects growing rabbits

and nursing does: very soft pellets are mixed with a translucent, gelatinous substance called mucus. Autopsy shows the colon and rectum filled with considerable amounts of this mucus, which somewhat resembles egg white. All sorts of hypotheses have been put forward to explain this type of diarrhoea. It is now universally considered a particular expression of enteritis which can have many varied causes: bacterial (*E. coli*, etc.) or nutritional (not enough water and/or not enough roughage).

#### *Enterotoxaemia, colibacillosis, typhlitis.*

These various names, like mucoid enteritis, refer in fact to types of enteritis which may have different causes but are very similar clinically and necroscopically. The diseases often develop rapidly (three or four days). Death can intervene before diarrhoea appears. When developing enzootically in a rabbitry there are phases of mucoid diarrhoea or constipation.

The autopsy shows lesions not dissimilar to those described for coccidiosis. There is more gas in the caecum, which is frequently mottled with red striations. The liver and kidneys sometimes look abnormal (crumbly liver, discoloured kidneys). The bacteria most often blamed are *Clostridium* spp. and *Escherichia coli*.

Clostridia (*C. perfringens*, *C. welchii*, *C. septicum*) are hardly ever isolated in growing rabbits after weaning. Perhaps this is partly because these are anaerobic germs which require a battery of special techniques for isolation and identification. *Clostridium spiroforme* has often been described in rabbits in recent years. This type of enteritis is common, mostly in well-fed animals (perhaps due to excess protein?). Both young and breeding animals may be affected. The diarrhoea is often very liquid and characteristically quick to putrefy. The corpses are blown up and the autopsy reveals greenish viscera. Treatment aimed specifically at anaerobic bacteria can be

effective (Dimetridazol, Tetracycline + Imidazol, etc.).

*E. coli*, on the other hand, occur systematically in very large numbers in rabbits with diarrhoea or even with coccidiosis. It should be remembered that a healthy rabbit, unlike all other animal species, hosts very few colibacilla ( $10^2$  to  $10^3$ /g faeces). Some authors have isolated nearly 200 different strains in sick rabbits. Fortunately, not all are pathogenic and the number of serotypes (strains) involved is relatively small. Serotype O103 is virtually the only one considered specifically pathogenic in France. Licois (1992) and Peeters (1993) have done wrap-up studies.

The enteropathogenicity of these strains comes from toxins they secrete. However, diarrhoea has rarely been produced experimentally using these enteropathogenic strains alone (O103). For these *E. coli* to cause diarrhoea the animal has to be under some other stress at the same time (unbalanced feeding, coccidia, thermal shock, etc.).

Strictly speaking, colibacillosis is mainly a postweaning disease. Diarrhoea in unweaned rabbits is usually a consequence of poor maternal health. Since the young drink only milk, to treat neonatal diarrhoea one treats the mother. There has to be enough antibiotic in the milk. Because antibiotics are held back and rapidly broken down by the intestinal wall, the drug administered in the dam's feed must be supplemented by parenteral administration. Rabbits are less susceptible to diarrhoea after seven to eight weeks. Broad-spectrum antibiotics (colistin, flumequin) plus general hygiene can redress the situation where there is no other major primary cause, e.g. feed, population density or maternal health.

Some antibiotics are very toxic to rabbits, particularly penicillins, ampicillins, amoxillins and other betalactamins, virginiamycin, lyncomycin and oxolinic acid (toxic embryo).

**Conclusion.** While the clinical and necroscopic appearance of these diarrhoeas of non-parasitic origin differs somewhat from that of coccidiosis, the conditions governing their occurrence are the same. First and foremost the field conditions must lend themselves to the spread of the infectious agent (*E. coli* or coccidia). Some factors perhaps more specifically favouring this type of diarrhoea are excess protein in the diet (over 18 percent) combined with insufficient roughage (under 10 percent indigestible crude fibre). Such enterotoxaemia, often associated with coccidiosis, is frequently reported from farm rabbitries where the rabbits are fed fresh-cut forage which is strewn on the ground.

Curative treatment is always too late, given the acute nature of this kind of enteritis. Antibiotics and sulpha drugs will prevent the spread of the disease and very often it is enough to replace the feed (pellets or green forage) by some good dry hay to cut losses. But if nothing is changed in the general conditions of the rabbitry, the same problems will soon recur. Chronic pasteurellosis, particularly during fattening, is also a direct or indirect cause of diarrhoea and mortality in rabbits.

#### Other gastrointestinal parasites

Glancing through a book on parasitology the reader soon discovers that several dozen different sorts of parasite can be found in the rabbit's digestive tract. They will not all be dealt with here as most are either very rare or only pathogenic under exceptional circumstances, or else little known or unknown in domestic rabbits. But in the farm rabbitry context, especially in the tropics, it is useful to have a basic grasp of the biological conditions that favour the development of such parasites.

Only two intestinal parasitic diseases are found in rational rabbit production in Europe: coccidiosis and oxyurosis. Wild rabbits living in the same regions, however,

have many other parasites. The main reason for this has to do with the various parasite cycles. Many are heteroxenous (multihost): to multiply and develop they must live successively on several hosts. For example, the little liver fluke shifts from mammal to snail to ant to mammal. Others are monoxenous (single host) but the larval or adult form develops only in the outside environment under certain conditions (wet grassland, stagnant water, etc.). This explains why rational production, by breaking the life cycle of these parasites, has eliminated the parasitic diseases they cause.

#### *Intestinal parasites found in farm rabbitries.*

*Cysticercosis* (tapeworm). This common parasite produces fine, white streaks on the liver and translucent cysts, alone or in bunches, on the peritoneum and viscera. The cysts are produced by the larvae of dog and cat tapeworms. Rabbits are contaminated by eating feed that has been in contact with excrement. The terminal hosts (dog, cat, fox) become carriers by eating rabbit viscera. Symptoms are few – sometimes diarrhoea – except with heavy infestations (not uncommon) when growth rate slows. There is no curative treatment. The other domestic animals have to be treated. Tapeworm larvae of other species of animals (pig, rat, etc.) can also infest rabbits. It is worth mentioning here that the larvae of some dog and cat tapeworms can infest not only rabbits but people as well (echinococcosis, coenurosis). The lesions are cyst clusters forming translucent "tumours" on the viscera or in the brain.

*Taeniasis* (tapeworm). Half a dozen tapeworm varieties can infest rabbits which become contaminated by eating mites in wet grass. Clinical symptoms are slight: mild diarrhoea, sometimes weight loss, very rarely mortality from intestinal perforation. A necropsy reveals flat worms, a few millimetres wide, varying in length by species from 1 cm to 1 m.

Tapeworms are seldom found in domestic rabbits. Treatments applicable to other animal species may be used.

*Fasciola* spp. and *Dicrocoelium* spp. (trematodes). Liver fluke (*Fasciola hepatica*) and little fluke (*Dicrocoelium lanceolatum*) are also very rare in rabbits. The conditions of infestation are the same as for ruminants. The intermediate hosts are certain snails found in grass from marshy areas (*Fasciola* spp.) or other types of snails and ants (*Dicrocoelium* spp.). Usually the only symptom is slowed growth. Treatment is pointless.

*Trichostrongylus* (nematodes). These are also small round worms (called roundworms), measuring 4 to 16 mm in length. The *Graphidium* (stomach worm) is rare in Europe but *Trichostrongylus* is very common in farm rabbitries. Rabbits become infested by eating green forage contaminated by larvae. The intrinsic pathogenic strength of these parasites is relatively weak, but they do greatly aggravate other rabbit ailments, particularly diarrhoea. Massive infestations can cause extreme inflammation of various parts of the intestinal tract (stomach, small intestine, caecum). The conventional anthelmintics (thiabendazole, phenothiazine, tetramisole) can be used for rabbits. It is recommended that regular treatments be applied every month or two in contaminated farm rabbitries.

Two other small roundworms are frequently found in rabbit caeca and colons: *Passalurus* (oxyuris) and *Trichuris*. These do not appear to be pathogenic except with massive infestations.

*Strongyloides* (nematodes). These are small roundworms, a few millimetres long, that are able to migrate throughout all organs and reach the intestine. The aetiology and epizootiology are identical to those in ruminants and pigs. Some massive infestations have been described in rabbits living in dark, damp, poorly kept hutches.

***Preventive hygiene and intestinal parasites.***

Intestinal parasitism is very common in wild rabbits. It is frequent and not of great economic importance in farm-bred domestic rabbits if overall sanitary and health conditions are satisfactory. In poorly kept hutches, or where infestation is massive, these parasites enhance all other ailments, both intestinal and other, making them acute, enzootic and lethal.

Rational rabbit production has done away with all these intestinal worms. Control is easy; it is only necessary to break the parasite's life cycle. Essentially this means taking the following measures regarding forage:

- it should not be gathered in areas where there are large numbers of dogs, cats or wild rabbits;
- it should be stored out of reach of these animals;
- it should be gathered at midday when the dew is gone (avoiding marshy areas) and not be cut too near the ground, because many of these parasites avoid dry surroundings and strong light;
- it should be sun-dried before it is given to rabbits – drying kills most of the worms and their larvae;
- it should be distributed on feed racks where animals are unable to soil it with their faeces or urine.

Parasitism can be considerably cut back by frequent changing of the straw litter, which should always be dry. Late slaughter of fattening rabbits (three months or more) is a negative factor, as some parasites (oxyuris) have a rather long life cycle. This is interrupted by earlier slaughter. Regular treatment can also include broad-spectrum anthelmintics or copper sulphate-based preparations in drinking-water (1 percent) for one or two days.

**RESPIRATORY DISEASES**

Respiratory ailments are common among domestic rabbits. In rational production they essentially strike breeding adults. In a

farm rabbitry young rabbits can also be affected. Where such ailments are endemic, losses are especially to be feared among the females, in which the disease becomes chronic, leading to production stoppages and mortality among the nursing young. Respiratory diseases usually remain endemic, but abrupt epidemics, which can decimate the stock in a few weeks, sometimes break out in farm rabbitries.

**Clinical features**

The first symptoms are a clear, fluid nasal discharge and frequent sneezing. The rabbit often rubs its nose with its forepaws, the fur of which becomes matted and dirty. This is the first stage, or common coryza, which affects the upper respiratory tract.

Later the discharge turns yellowish, thick and purulent. Sneezing is less frequent but coughing may begin. Purulent coryza can remain stationary or develop into pneumonia, either spontaneously or from other specific or non-specific causes (enteritis, lactation, malnutrition, etc.). With pneumonia, coryza, sneezing, even coughing and snuffling may disappear. The only symptoms will be slower respiratory movements, clearly visible in the nostrils, and difficulty in breathing in. In young rabbits, growth slows or stops. Complications are frequent: diarrhoea, ophthalmia, sinusitis, torticollis (wryneck) and abscesses. Females can die suddenly during lactation or gestation.

At autopsy, coryza is manifested by the presence of pus in the nasal cavities and atrophy of the mucous membranes. The lungs may be congested and parts may have a liver-like appearance. Very often there are lung abscesses with abundant yellowish-white caseous pus filling most of the chest cavity.

**Causes**

As with diarrhoea, respiratory infections are due to an association of non-specific contributing causes with infectious agents.

Many of the non-specific attacks mentioned in the previous sections are decisive for the development of respiratory ailments. Control of chronic enteritis in fattening units, in particular, will reduce the incidence of coryza. Other contributing causes are directly linked with rabbit respiratory physiology. The lungs are protected by the rabbit's very developed, very complex nasal cavities. These cavities are covered by the pituitary membrane which acts as a filter to stop dust and airborne microbes. It is therefore essential to protect this mucous membrane and keep it intact. The pituitary membrane is particularly sensitive, which may explain many of the following observations:

- abrupt cooling of the air can be the sole cause of common coryza, which may clear up spontaneously and quickly in a healthy environment;
- dust (crumbly granulated feed, pollen, dust in the air from dry sweeping or a nearby dirt road) can cause common coryza through the reflex action of the pituitary membrane, but may also clear up quickly;
- air flow, humidity and temperature are three very closely linked environmental factors that are instrumental in triggering respiratory ailments. At lower temperatures the air must be correspondingly drier and move more slowly. Rabbits seem to be very sensitive to draughts. Air flow should not exceed 0.30 m/second unless the humidity is more than 75 percent. Ventilation errors in closed buildings are the chief cause of chronic pneumonia;
- ammonia and gases forming from decomposing, urine-soaked straw litters may quickly break down the pituitary membrane and gain direct access to the lungs.

**Infectious agents.** Three constants of disease agents are the randomness of their pathogenic strength, their numbers and

the fact that they are interchangeable. In other words, only some alteration in the mucous membranes of the upper respiratory tract will allow the germs present to develop to their specific pathogenic strength.

**Bacteria.** Pasteurellosis is the disease most often cited, because rodents and lagomorphs are particularly susceptible to this germ. Pasteurellosis may take many forms in the rabbit: abscesses, mastitis, diarrhoea, metritis, wryneck or septicaemia. The rabbitry can easily become thoroughly infested, to the point where pasteurellosis can become endemic. Some pasteurella strains are more pathogenic than others. Pathogenicity can be acquired during the endemic stage, provoking an epizootic outbreak in the rabbitry or even in the entire region (Rideau *et al.*, 1992). While pasteurella is the worst and most common of the germs isolated from the respiratory apparatus of a sick rabbit, there are others: e.g. klebsiella, staphylococci, streptococci, bordetella, *E. coli*, salmonella and listeria. These are usually secondary infections or associations such as streptococci and bordetella.

All production units are contaminated with pasteurella and, while there may not be respiratory pasteurellosis, the constant threat is there, and varies with the pathogenic strength of the strain.

**Viruses.** Apart from myxomatosis, which now seems more and more likely to cause pneumonia, no respiratory virus has been described in the literature. Viruses certainly do exist, however, and in rabbits as in other animal species, the problem is the bacterial complications which follow viral infections.

**Parasites.** There are several species which can develop in the lungs (*Protostrongylus* spp., linguatulids, etc.). They are relatively uncommon in domestic rabbits because, as with intestinal worms, an intermediate host such as a snail or dog is required. Only a laboratory analysis can reveal the presence of respiratory parasites.



### Epidemiological and physiopathological elements

Pasteurella are basically transmitted through direct contact such as mother to progeny, male to female, or via a vehicle such as the drinker, the trough or the breeder's hands. These bacteria cannot live very long outside the body, making sanitary isolation effective. Airborne transmission is infrequent and only effective if the air is full of dust or water particles.

In a healthy production unit, young rabbits are unlikely to be contaminated before the age of 21 to 25 days. Most adults are silent carriers. The sites most commonly colonized are the sinuses, vagina and middle ear. Autopsies show that more than 60 percent of female rabbits have asymptomatic pasteurella-associated otitis of the middle ear. Pasteurella are carried into the inner and middle ear by the lymphatic system in a two-way direction.

Other pasteurella affections are frequent: cutaneous abscess, mastitis, vaginitis and metritis; the last two more frequent in units where artificial insemination is practised with unsterilized implements. All these external suppurative forms are incurable and affected animals must be culled immediately.

### Respiratory disease control

**Chemotherapy.** Tetracyclines are pneumotropic antibiotics well tolerated by rabbits. Chloramphenicol and sulfadimethoxine are also often effective. Dosages vary according to the preparation but treatment should always be for three to four days. The medicine is best injected intramuscularly. Whenever a bacterium is isolated in the laboratory it is strongly recommended that an antibiogram be made immediately. Although antibioresistance is rare in rabbit pasteurellosis, resistance to streptomycin, spiramycin and the sulphonamides is reported. Systematic preventive antibiotic treatments are both useless and dangerous.

**Vaccination.** The numerous vaccines on the market are of very uneven effectiveness. Most of them are pasteurella-based and sometimes bordetella-based. It is difficult to immunize rabbits against these two germs, whatever the quality of the vaccine. The main point is that bacteria are only exceptionally the direct cause of the disease, so that even if the rabbit is protected against pasteurella, it can still catch pneumonia from streptococci or staphylococci.

Given the large number of pasteurella strains and their variable pathogenicity, autovaccines are always preferable. Furthermore, to be at all effective, vaccination must be performed on healthy animals just after weaning and repeated one month later. Action is generally taken during the course of the disease only. Vaccination and chemotherapy are merely temporary measures to back up preventive hygiene.

**Preventive hygiene.** Preventive hygiene is the *sine qua non* of successful respiratory disease control, even more so than for digestive disorders. Where pasteurellosis is endemic in a nursery, the breeder needs to know that a long battle lies ahead for which the following strategy is proposed. Where possible, the first action, before administering antibiotic treatment, is to remove two or three sick rabbits to identify the germ, make an autobiogram and perhaps prepare an autovaccine. Successful control depends on culling sick animals, which the breeder will need to be able to replace. Pasteurellosis control should be preceded by the preparation of new breeding females from the youngest (newly weaned) animals which have been isolated, treated and perhaps even vaccinated.

The first stage of pasteurellosis control is the elimination of all clinically diseased animals: i.e. those with signs of suppurating coryza, sniffing, breathing problems, abscesses, mastitis, vaginal discharge, etc. The second stage is to analyse the nursery

environment: i.e. air flow, ammonia, humidity, temperature, dust content. No specific control is possible unless the environmental problems are identified and solved. The third stage (and hopefully not the first) is antibiotic treatment with tetracyclin, chloramphenicol, etc.; it is particularly effective if administered for long enough and by parenteral injection.

The bacteriological clean-out of the unit should be supplemented by extra-rigorous cleaning of the floors, walls and all equipment and implements.

Culling of the sick is to be followed by the removal of healthy carriers such as old females, non-productive females, females that refuse mating or that abort, females with coryza in the late stages of pregnancy, etc. Male rabbits are formidable healthy carriers.

New females should not be brought in until the situation has improved, i.e. several weeks after the start of the operations. This must not signal a slackening of vigilance in either maintenance of a sound environment or good hygiene. Culling of the breeding animals retained should continue.

#### OTHER DISORDERS OF THE RABBIT

There are many rabbit diseases other than digestive and respiratory ailments. Most have disappeared from intensive rabbit production without the reason always being known. Others are still found in farm rabbitries but are rarely of economic importance. The following is a brief review of diseases that are not uncommon.

##### Myxomatosis

This is a viral disease (Sanarelli virus) which decimated rabbits in Europe for more than 20 years after being introduced into France in 1952. The Sanarelli virus develops in certain American rabbits, *Sylvilagus* (cottontails), without causing the disease, thus making them dangerous carriers.

Myxomatosis is extremely contagious and can be transmitted in many ways. Biting or

#### Pasteurellosis eradication plan: order of operations

1. Cull live animals for laboratory examination (antibiogram and autovaccine).
2. Prepare a stock of future breeders to replace animals culled, isolate them, treat them and vaccinate them if possible.
3. Cull sick females, including those with suppurating coryza, sniffing, breathing problems, abscesses, etc.
4. Check and modify the environment (air flow, ammonia).
5. Administer appropriate antibiotic treatment to the remaining stock.
6. Wash and disinfect cages, hoppers, drinkers, floors and walls.
7. Continue to eliminate healthy carriers for several weeks or even several months, i.e. cull females which are not productive, refuse the male, do not get pregnant or abort.
8. When the situation improves, renew stock with young vaccinated females and continue the accelerated renewal of the entire stock.

stinging insects such as mosquitoes and fleas are the main vectors because of the rapidity with which they can inoculate animals and the distances they are able to fly. Spread by animal-to-animal contact or from contaminated equipment is also common. It now appears certain that pulmonary contamination is possible in confined rearing. This virus is very resistant to weather and physical changes (cold, dryness, heat) and disinfectants. Formol, however, is very effective and is recommended for disinfecting equipment.

The first symptoms are inflammation of the mucous membranes (eyelids, genital area) which thicken and form small tumours. These tumorous nodules are found first on the tips of the ears and then all over the body. The tumours adhere closely to the skin and grow until they finally deform the whole head. Numerous nodules can be felt under the skin on the back.

Respiratory forms of the disease with no other symptoms also seem to be common. Clinical diagnosis is then impossible. Recovery is rare but not unheard of when the animal can eat and there is no secondary infection; however, the rabbit then becomes a healthy carrier of the virus.

There is no treatment, nor should there be. Vaccination is effective and can be done with a heterologous virus such as the Shope virus, which causes a small benign nodule in rabbits, or with a weakened form of the myxomatosis virus. In Western Europe the first is more popular, in Hungary the second. Prevention requires good hygiene and insect control, especially of lice and fleas in farm rabbitries.

Breeders or countries buying rabbits should ensure that the animals have been vaccinated for more than three weeks but less than two months before purchase, and that they come from a healthy rabbitry where regular vaccination is the rule.

#### **Viral haemorrhagic disease (VHD)**

There are many synonyms: RVHD (rabbit VHD), viral hepatitis, haemorrhagic hepatitis, X disease, etc.

**Epidemiology.** The epizootic form of this disease appeared in China in 1984 and spread rapidly throughout the world. By 1988, it had reached all of Europe and the American continent (Mexico, Venezuela, etc.).

The epizootic disease is most spectacular where farm rabbitries or wild rabbits are heavily concentrated. (In Italy, for instance, an estimated 80 percent or more of the farm rabbitries were entirely decimated within a

few months.) One or two years later these epizootic forms appear less frequently and are less widespread, but the disease remains endemic.

However, when VHD hits a previously unaffected country, as in Cuba in 1993, the extent and evolution of the disease are dramatic. In general, animals over eight weeks old, particularly adults, are the most susceptible to VHD.

Frozen Chinese rabbit meat was the original source of contamination in Western Europe and Mexico. All producer countries of meat, by-products, breeding animals, etc. are now contaminated. Even though rabbit VHD spreads very quickly, few industrial production units in Europe except Spain were affected since they use only granulated feed. The forage collected by breeders is often suspected of being the principal vector of the virus.

**Symptoms and lesions.** When the disease appears in a rabbit production unit, it spreads immediately. Death occurs within three days after exposure and, in the chronic form, survivors recover in one week. The clinical symptoms are straightforward: fever, sudden death, sometimes preceded by convulsions and cries. Ante-mortem epistaxis is spectacular but not frequent. The disease is fairly easy to diagnose thanks to the dramatic mortality throughout the rabbitry (20 to 40 percent per day), particularly in adult rabbits.

The characteristic post-mortem lesions are:

- haemorrhagic syndrome throughout the respiratory apparatus, liver and intestine;
- congestion of the kidneys, spleen and thymus;
- frequently major enlargement of thymus and liver, the liver showing the most constant lesions, discoloration, a "cooked" appearance, very marked lobular patterns;

- clear failure of coagulation revealed by incision of the organs in fresh cadavers;
- necrotic hepatitis and general intravascular clotting in all organs, the most typical lesions revealed by histopathology.

**Causes.** Although the RNA virus which causes VHD has never been cultivated, most authors now agree that it should be classified in the family of the Caliciviridae. It is very resistant to freezing, ether, chloroform and proteolytic enzymes. It can be inactivated by formol or beta-propiolactone. It is destroyed by bleach, soda and the phenols.

The first target cells in the organism are those in the reticulo-endothelial system. The virus can subsequently be found in all cells, particularly the hepatocytes. Indeed, the purified virus used to produce inactivated-virus vaccines is taken from the liver.

**Prevention and treatment.** There is no treatment. Preventive hygiene measures have proved inefficient except in industrial-scale rabbitries. Several vaccines have been made from the inactivated viruses. They act very swiftly (two to five days) and confer six months of protection. In areas where the disease is endemic, vaccination is essential and effective. When an epidemic breaks out in a rabbitry in a region, immediate vaccination following the first fatality can save a production unit. The major problem in contaminated countries is having enough vaccine on hand to intervene immediately.

Two different policies are recommended for imported or new breeding animals (in addition to the standard measures such as quarantine): they are prior negative serological test or vaccination. Neither is entirely reliable because the specificity of the test is low, and the disease has a very short incubation period. Vaccination would be the method of choice as the virus apparently does not multiply in vaccinated ani-

mals, but formal confirmation of this point is still pending.

Finally, despite the numerous similarities (virus, symptom, epidemiology), the disease European brown hare syndrome (EBHS) is not transmissible to rabbits and vice versa.

#### Foot pad abscesses

Foot pad abscesses are a very common complaint, familiar to all breeders. Chronic abscesses are far more frequent under the hind paws. They start as a barely visible swelling which can be felt by palpation. They may be limited to the cutaneous and conjunctive tissues. The skin becomes thick (parakeratosis) and scabby. Infection is latent and the sores may bleed. Poor cage floor hygiene can cause heavy secondary infection. The abscess then covers the whole metatarsus and becomes purulent.

These abscesses are found in farm rabbitries and in intensive production where mesh floors are used. Breeding animals are especially prone to this disorder. In farm rabbitries the main cause is poor upkeep of the straw litter, which becomes damp and rots. Various infections can follow (staphylococci, fungi) but the worst is a *Corynebacterium* (Schmorl bacillus) which gives rise to an evil-smelling necrotic gangrene which can spread to the head and the whole body and then to other animals (necrobacillosis).

This disease is rare where rabbits are raised on wire-mesh floors, but sore hocks (caused by staphylococcus) are much more common than in rabbitries where straw litter is used. Poor quality, rough or twisted wires, wrong mesh size (too wide) and rust are the main culprits, all fostering the development of foot pad abscesses. It is difficult to raise heavy rabbit breeds on wire mesh.

The control of foot and hock diseases is primarily preventive and consists of the following:

- choice of medium-weight breeds and animals whose foot pads are well furred

to protect the skin, such as the New Zealand White and the Californian;

- use of thick, galvanized, welded wire mesh (mesh size 13 to 15 mm); it should not irritate the palm of the hand when rubbed;
- straw litter always kept dry and clean;
- frequent washing and disinfecting of cages.

Treatment is difficult. When there is no obvious suppuration the sores may be treated every day and then every two days with strong disinfectants such as iodine, Fehling liquor, paraffin oil and permanganate. The antifungoid action of iodine and permanganate is useful too in units using the litter system, which fosters complications with fungi. Antibiotic ointments are not recommended because the treatment is long and expensive and the ointments soften the skin. When the abscesses become purulent or the forepaws are affected the infection is then incurable and the animals should be culled. If other abscesses are noted, especially on the head (necrobacillosis), the bodies should be burned or buried deep. Foot pad abscesses make it practically impossible for males to mate.

#### **Buck-teeth**

Buck-teeth prevent the upper and lower incisors from touching and so they do not wear down. The incisors keep growing and eventually prevent the rabbit from eating. Buck-teeth may be hereditary (jaw malformation), or the result of injury (teeth broken against wire mesh). There is no connection with the type of feed—forage, hard granulated feeds and so on. The only prevention is breeding. Teeth should be carefully examined when buying or choosing a breeding animal. Treatment consists of cutting the teeth with sharp pliers right down to the gums every 15 to 21 days.

#### **Ear and skin mange**

Ear canker or mange is very common. It is a parasitic disease caused by a mite (*Psoroptes* or *Chorioptes*) and frequently com-

plicated by bacterial infection. The symptoms are external otitis and yellow or brown scabs in the ear canal. The course of the disease can be very long. The scabs become waxy and invade the whole ear. The inside of the ear becomes scaly. The middle ear may then be affected, causing wryneck (the rabbit's head is held constantly to one side).

Treatment can be effective if the disease is caught in the very early stages, that is, as soon as small yellow-brown deposits are noticed in the ear. Insecticides are applied locally in the ear. Organophosphates such as malathion are preferable to organochlorines (DDT, lindane) which, although very active, are dangerous to humans. Glycerine, iodized oil or cresyl oil are also effective when applied frequently.

Prevention involves culling rabbits whose external ears are severely affected, and treating all other rabbits for several days running and then every fortnight. Throughout the treatment the straw litter must be changed frequently as the parasites can stay alive in the litter for a long time.

Ivermectine is unquestionably the drug of choice; two 200 mg injections per kilogram of live weight every eight hours provides a spectacular cure. The product is very persistent and if the stock is carefully treated at the same time and the rabbitry cleaned out, it will be effective for several months. This is a very strong medicine and should be reserved for breeders, for animals treated with it cannot be eaten for several months.

Skin mange is much less common. Today it is only found in poorly managed rabbitries. Lesions start at the edge of the lips, nostrils and eyes, spreading to the head and forepaws as rabbits frequently rub their heads. The skin dries, the hair falls out and the skin becomes scaly and finally scabby. The skin mange mites, *Sarcoptes* and *Notoedres*, are not of the same family as ear canker mites. Treatment is the same, but prevention measures (culling diseased rabbits, cleaning cages) must be stricter.

### Skin diseases

**Ringworm.** Also called dermatomycosis or trichophytosis, ringworm is a skin and hair disorder. Not very common in farm rabbitries, it is widespread in intensive rabbit production. It starts with circular bald patches, usually on the nose. The hair looks clipped and the skin is irritated and inflamed. More small patches appear on the head, ears and forepaws and then over the whole body. On the oldest lesions the hair can be seen growing again in the centre.

It is a very contagious infestation that can sometimes be transmitted to humans, although it is more commonly transmitted to other domestic animals such as dogs and cats. Ringworm is caused by microscopic fungi that can belong to different genera (*Trichophyton*, *Microsporum*, *Achorion*) and are not specific to rabbits. There is no economic loss as long as infestation is light.

Treatment is long and costly. An antimycotic, Griseofulvin, is administered in the feed for about ten days. During treatment all equipment should be frequently cleaned and disinfected in a 5 percent formol solution. Many producers, successfully it seems, sprinkle powdered sulphur (sulphur flowers) on the ground, cages and nesting boxes. In small rabbitries local treatment can be applied with antimycotics in powder or liquid (tincture of iodine and other dyes), but preventive hygiene should accompany the treatment. Badly afflicted animals should be culled and domestic animals treated.

**Ectoparasites and trichophagy.** As well as the lice and fleas that are specific to rabbits, ectoparasites of other animal species, particularly poultry, can also bother rabbits. Not found in intensive rabbit production, these farm rabbitry ectoparasites can harm production and, worst of all, they are the vectors of many disease agents, including the myxomatosis virus. With good hygiene and external antiparasitic preparations they can be rapidly eliminated.

Trichophagy or fur-eating occurs both in farm rabbitries and in units using wire-mesh floors. The animals eat each other's fur and end up with bare backs and flanks. All sorts of diagnoses have been advanced: unbalanced rations, behavioural problems, unsuitable environment, amount of light, overpopulation, genetics and so forth. It was very widespread when wire-mesh cages were first used extensively, but seems to be declining with the general improvement in production conditions (equipment, feed, strain). There is no exact preventive measure and no specific treatment.

### ZOONOSES

Zoonoses are diseases shared by many animal species and humans. Most have no special feature peculiar to rabbits and are rarely contracted by them (rabies, tetanus, etc.). Therefore only a few are mentioned here, either because they can be dangerous to people or because the appearance of the disease in the rabbit reveals its existence on the farm or in the village.

### Tuberculosis

This disease is very rarely reported in rabbits. Nevertheless it does exist and may be of avian, bovine or human origin, in decreasing order of frequency. The rabbit is very resistant to tuberculosis, so the disease evolves very slowly. The lesions, which are the sole indication of tuberculosis, can only be seen in breeding animals. The main organs affected are the lungs and less frequently the liver, intestine and kidneys. The spleen is very rarely affected. The classic tubercular nodules are found in the parenchyma of these organs, often containing an almost solid cheese-like pus.

### Pseudotuberculosis

This is more common in guinea-pigs, wild rabbits and hares than in domestic rabbits reared on straw litter. It has almost disappeared with modern wire-mesh cage pro-

duction. Pseudotuberculosis is one cause of synovial arthritis in humans. The germ *Yersinia pseudotuberculosis* provokes numerous whitish nodular lesions on the intestinal viscera, especially the spleen, which become enlarged. These nodules, ranging in size from a lentil to a chickpea, are sometimes amalgamated. They are scattered throughout the abdominal cavity but are rarely found in the lungs. Apart from steady weight loss there are no symptoms to diagnose. The disease can easily be recognized by post-mortem examination.

#### **Tularaemia (rabbit fever)**

This very contagious disease is common in hares, but rabbits seldom contract it. Its significance is the danger it represents for humans. A bacterial disease caused by *Francisella tularensis*, it gives rise to high fever, leaving the animals in a semicomatose state. Lesions are enlargement and congestion of the spleen. The liver is often dotted with numerous tiny greyish-white spots (miliary necrosis) about the size of a grain of millet.

#### **Listeriosis**

This disease is less rare than tularaemia, and still appears sporadically in farm rabbitries. A septicaemic disease caused by *Listeria monocytogenes*, it is very difficult to diagnose clinically. Listeriosis should be suspected when the following symptoms appear on the farm:

- nervous upsets: photophobia, spasms, wryneck;
- abortions in does or ewes;
- miliary necrosis of the liver and spleen (without enlargement).

#### **Toxoplasmosis**

This disease is unquestionably more common in farm rabbitries than is generally believed. It is caused by the intermediary stage of an internal cat and dog parasite, *Isospora*. The course of the disease does not

usually produce symptoms, although there may be jerky nervous reactions. The lesions are translucent cysts in the brain and in muscles or viscera. Often the spleen is enlarged.

#### **Conclusion**

Zoonoses are infrequent in farm rabbitries and have apparently never been identified in intensive rabbit production. This is because contamination is usually spread by forages polluted by other animal species. Zoonoses are also usually diseases of adult animals; the early slaughter of animals (10 to 12 weeks) limits their spread. When these diseases are suspected the dead animals should be burned or buried and human hygiene intensified. Although antibiotic treatment may be effective in certain cases it is best not to treat but to cull the entire stock. Good hygiene is the only prevention. Apart from the usual rules of cleanliness, forage must be cut and stored with special care. Rats and mice are formidable propagators of these diseases. Rat extermination around rabbitries is fundamental.

#### **TRYPANOSOMIASIS**

There are few data on this disease. Various findings from Africa on the subject, while not contradictory, are not uniform. It has been demonstrated that rabbits can contract trypanosomiasis experimentally or in special circumstances. They are particularly susceptible to *Trypanosoma brucei*.

There are reportedly some rabbitries in tsetse fly areas, for instance in Côte d'Ivoire, with no recorded cases of spontaneous outbreaks of trypanosomiasis in rabbits. Trypanosomiasis has caused some problems in Mozambique, however. It has been reported that its symptoms are oddly like those of myxomatosis.

*Note:* Other diseases that are transmissible from rabbits to humans, or common to both, have already been mentioned. By contrast,

neither rabbit variola (pox virus) nor rabbit syphilis (*Treponema cuniculi*) can be transmitted to humans.

#### REPRODUCTIVE DISEASES AND DISORDERS

A doe can produce over 60 young in one year, but few breeders are in a position or context to exploit this potential fully. Rabbit maternities are the source of many disease problems. The breeder should focus efforts on the nursery and on maternal health, the prime guarantee of obtaining healthy young rabbits at weaning. Productivity factors in the rabbitry (frequency of mating, litter size, age at weaning) depend at least as much on the breeder, equipment, feed quality and quantity as on the female rabbit's potential.

Maternal health determines the survival of the offspring

All the diseases mentioned above can affect breeding females. Only a few points peculiar to reproduction will be mentioned in the following paragraphs and the relative importance of the major diseases of females will be discussed in order of importance.

#### Respiratory infections

Respiratory ailments are the main disorders affecting pregnant rabbits in closed rearing. In intensive production, apart from the environmental causes described earlier, lactation must be added as a contributing cause. In young nursing does, hard-to-diagnose ailments can be complicated by acute or subacute pneumonia. The doe may die before weaning her litter or she may have to be culled shortly afterwards.

#### Digestive disorders and enterotoxaemia

Digestive diseases are far less serious in adult animals than in growing rabbits. The classic coccidiosis-type diarrhoea is rare in adults. Intestinal parasitism (coccidiosis,

strongylosis) will be latent or chronic, fostering the appearance of other diseases.

Enterotoxaemia is more common, especially in farm rabbitries. It can develop very rapidly (one to seven days) with or without mucoid enteritis. Most often it occurs in late pregnancy or mid-lactation, sometimes in association with symptoms of acute pneumonia. In traditional rabbitries, complications of paresis or paraplegia are common, especially in fat, overfed does working at low-intensity breeding rates. Control in this case involves adapting the reproduction rate to the feeding capacities of the production unit. There is no treatment.

#### Metabolic disorders

Some 25 to 30 percent of does in intensive production die, usually with no warning symptoms. Mortality occurs in mid-lactation in young first- and second-litter females and in the latter stages of pregnancy in older does. Often called enterotoxaemia, this illness is certainly not of infectious origin, although bacterial complications are common. It is rather more like a metabolic disorder, such as milk fever in ruminants or eclampsia in women. Its aetiology is still not clear. There is no curative treatment. Mortality can sometimes be reduced by preventive doses of calcium in drinking-water or parenteral injections (Ca gluconate) just before kindling.

#### Abscesses and mastitis

Abscesses are very common in rabbits. They sometimes grow to enormous size, and develop very quickly without any apparent change in the animal's health. There are two preferential sites in does: the sub-maxillary area and the teats. These and foot abscesses are the main reasons for culling breeding does.

Most often the cause is *Staphylococcus aureus*, but other germs may be present. The worst are *Pasteurella*, which can make



the disease epizootic and lead to numerous complications (pneumonia, septicaemia, abortion). Mastitis is common in units with mesh floors and is probably fostered by congestion caused by chilling. When mastitis is in the congestive stage (hard, reddened mammary gland but no pus) the disease may be staved off by a three-day antibiotic treatment and the local application of astringents (vinegar) twice daily to aid decongestion. It is uneconomical to treat abscesses or purulent mastitis.

### Chlamydiosis

*Chlamydia psittaci* is found in rabbits. The clinical symptoms are many: refusal of the male, early miscarriage, peri-partum haemorrhage, hydrocephalus and poor viability of newborn rabbits. Tetracycline as a preventive measure for the entire rabbitry is efficient but there may be relapses.

### Genital infections

**External genital organs.** The external genital organs (vulva, penis, scrotum) can be the site of specific venereal diseases. The best known is rabbit syphilis or vent disease, caused by a spirochete (*Treponema cuniculi*). It has never been reported in intensive rabbit production, but vent disease is not exceptional in rural rabbitries. Inflamed lesions become ulcerated. Bucks are often affected (orchitis, balanitis) and transmit the disease, which can turn enzootic. This is a benign disease which impedes mating; it can easily be treated with antibiotics (penicillin, tetracycline).

This disease can be confused with the onset of myxomatosis!

**Internal genital organs.** The internal genital organs can also become infected. These, far more serious, far more common infections make reproduction impossible.

Metritis or white discharge, a uterine infection, is often associated with mastitis and respiratory complaints. It is a major

rabbit disease. One symptom of metritis is an abnormal frequency of sterile does and mastitis in the rabbitry. Abortion, which is usually rare, may become more common. Metritis shows up at post mortem: the uterus is thickened and poorly retracted and there may be abscesses at the last embryo implantation site, sometimes covering the whole uterus (pyometra).

Aetiology is complex. Gestation and kindling are obviously contributing causes, but hygiene is a determining factor, and a chronic pasteurellosis in the rabbitry could be the culprit. The most common germs are non-specific: staphylococci, pasteurella. The specific germs such as toxoplasma, *Listeria* and *Salmonella* are much less common. Specific infections are likely if there is widespread abortion.

Antibiotics can be given, especially at the onset of the disease. But they will not be effective unless the most advanced cases, such as very thin does, or does with purulent mastitis or symptoms of pneumonia or purulent coryza, are culled. Preventive medicine, in this case vaccination, is only valid for pasteurellosis (see section on respiratory diseases). Preventive hygiene is decisive in controlling internal genital diseases.

### Non-infectious reproduction problems

**Sterility.** Absolute sterility is relatively rare. "Sterility epidemics" are usually seasonal and can often be traced to insufficient light (less than 14 to 16 hours). Sterility otherwise occurs after one or several kindlings (see previous chapter). Does serviced three times with no results should be culled for both hygiene and economy.

**Twisted uterus.** Cases of twisted uterus are not uncommon. This is discovered during post mortems on does that died during gestation. The causes are not clear. Overcrowding of the uterus and disturbance of does are frequent explanations.

**Delayed birth.** Delayed birth often occurs with small litters (one to three). Foetal retention is common in this case, invalidating the doe economically. In modern production, birth is systematically induced by injections of oxytocin on day 33 of pregnancy (servicing on day zero).

**Parturition outside the nest box.** Young first-litter females are the usual offenders. Disturbances, or mice in the nesting box, are possible causes.

**Prolapsus of the vagina.** There is no treatment for prolapsus of the vagina.

**Cannibalism.** Real cannibalism caused by abnormal behaviour in the doe is exceptional. The female usually eats only those young which are already virtually dead but still warm. This may happen a few hours or days after parturition. Insufficient drinking-water after parturition is considered a cause in farm rabbitries, and this could well be the true reason.

**Abandonment of the litter.** This is most often done by young females whose milk has not let down, or has let down too late. A doe that abandons two litters should be culled.

#### **The nest and young rabbit mortality**

Compared with other domestic animals, rabbits are still virtually in the foetal stage at birth. The survival of newborn rabbits, and hence the success of the rabbitry, is closely related to the quality and hygiene of the litter's immediate environment.

If the amount and type of materials used for the nest (straw, wood shavings, hay, etc.) are inadequate during the first few days, the newborn rabbits will get cold and death is then inevitable. The doe does little to intervene. She pulls fur to help make the nest; she nurses her young once a day and sometimes she will defend access to the

nest, but she does not care directly for the young. If the nest box is poorly designed and the young are able to get out after the first few days, the doe will not put them back.

If nest hygiene is poor (droppings, dampness) or if the mother is sick (mastitis, coryza) the young will develop a nostril-blocking rhinitis which will impair their sense of smell within a few hours. Their sense of smell is crucial as it guides them to the mother's teats. Small staphylococcal abscesses can quickly develop on the young rabbits' bodies (belly, groin, tarsus) under these conditions.

In modern French rabbitries with highly prolific does, an intensive reproduction system and adequate environmental conditions, an estimated 5 to 7 percent of the young are still-born and another 16 to 20 percent normally die before weaning. About a third of this mortality is accounted for by precocious dam mortality. Some of the young can be saved by fostering two or three to another nursing doe with young of the same age. The remainder of the losses take place during the first two weeks of lactation. Occasionally an entire litter is lost during the first four or five days.

The aetiology of these mortalities is not known, but it seems to have more to do with the doe's state (lactation?) than with any particular disease of the newborn rabbits. The above figures indicate that a mortality rate of less than 15 to 20 percent should not be considered catastrophic. On the other hand, after the first 15 to 20 days of lactation young rabbit mortality should be very low. If it is not, the dam should be examined for mastitis or coryza. Cage and nest-box hygiene should be checked. Pre-weaning diarrhoea (30 to 35 days) is a sign of inadequate hygiene. Coccidiosis indicates very poor hygiene.

#### **PREVENTIVE HYGIENE**

The word prevention has been constantly repeated throughout this chapter as essential for successful rabbit production. Careful hygiene is usually enough to prevent

major disease crises. Preventive medicines (vaccinations, anticoccidiosis treatments, etc.) have been described. They are not widely used in rabbit production. The basic rules of preventive hygiene are now set down in detail.

#### **Location and design of the rabbitry**

It has been emphasized from the outset that rabbits must have an environment in which they do not constantly have to withstand external disturbances and aggression. The rabbitry should be located whenever possible far from such nuisances as noise and dust (dust carries microbes), sheltered from the prevailing winds and, in hot countries, shaded from the sun. Rat and mice extermination should be considered, as both are formidable healthy carriers of diseases to which rabbits are susceptible.

Cleaning should be constantly kept in mind in the designing and building of a rabbitry. Nothing that cannot easily be cleaned and disinfected should be allowed. The rabbit's immediate surroundings (cage, feeding racks and drinkers in particular) should be portable, so they can be regularly removed, cleaned, dried and disinfected. In completely closed buildings the ventilation system should be carefully designed for flow without draught. Where ventilation is used, forced-air ventilation is preferable, as it keeps insects out and makes it possible to control the air flow by adding or removing vents.

Some authors insist that in tropical countries the interior of the building should be sufficiently protected to act as a buffer against extremes in temperature and humidity, especially during the rainy season, to cut down the incidence of pulmonary diseases. As an example, a rabbitry in Burkina Faso built with local materials (laterite bricks, palm framework, straw roofing) recorded a much lower range in temperature variations than did a "strong" building made of construction blocks with

a tin roof. Where possible, metal should be used for the wire-mesh hutch and accessories as it is the easiest material to clean and disinfect.

#### **Constant hygiene**

*Preventive hygiene.* The rabbit's excitability is a contributing factor in illness. Casual visitors such as feed suppliers, rabbit buyers and other breeders (who are vectors of diseases from other rabbitries) should be barred. Rabbits should be protected against dogs, cats and small wild carnivores.

*Feed and water hygiene* is basic as both can carry numerous agents of rabbit diseases (e.g. coccidiosis and worms). Feed should be stored out of the reach of domestic animals. It should be distributed in troughs or racks, but never on the ground. Drinkers should never be set on the ground. Rabbits drink a lot of water, but they will not drink dirty water. Water is the ideal medium for coccidia sporulation. Accordingly it should be changed and drinkers cleaned often.

*Cage and nest hygiene* is particularly important while the does are nursing. In wire-mesh hutches the cage must be removed and cleaned after each kindling. In farm rabbitries the straw litter must be renewed often. After kindling, any stillborn young should be removed from the nest and the nest remade if necessary. Contrary to widespread belief, a doe will not abandon her young if they have been touched. It is only necessary to keep the doe out of the nest during the cleaning operation.

After weaning, if straw litter is used, it should be kept clean and dry. The more animals per cage, the more difficult this is. In every type of production system weaning demands scrupulously clean, disinfected, dry cages. Weaning is one of the crucial moments in rabbit production. Transporting the animals, mixing up litters and using questionable cages should be avoided. Successful production depends on these details.

*Microbial infection.* It is also necessary to work constantly against any buildup of microbial infection. Chronically sick animals (with coryza, pneumonia, mastitis, abscesses), especially breeding animals, must be culled. One sick breeding animal in a rabbitry is of small value in relation to the danger it represents for the rest of the stock, the cost and uncertain outcome of treatment and the possibility of its quick replacement (sexual maturity at four months).

In completely closed buildings the control of microbial contamination should include the maintenance of walls, ceilings and especially floors. Damp or dusty floors are a permanent source of air pollution.

*Early slaughter.* Early slaughter (10 to 12 weeks) of animals for market is also a form of preventive hygiene. Many diseases take several months to develop before becoming contagious, especially in small or farm rabbitries.

*Human factor.* People are the most dangerous permanent vector of disease. They can bring in contaminants from the outside and so should wash their hands before entering and don footgear and a smock which always remain inside the rabbitry. Only a human being can palpate a doe suffering from mastitis and then systematically go on to infect all the mammary glands of the females to be palpated that day. Clean hands are extremely important, especially when handling animals and distributing feed and forage.

*Preventive medicines* to control parasitic diseases also help to maintain a healthy environment. Many parasites undermine the animals' state of health without causing directly perceptible losses and pave the way for a great variety of infections. However, the systematic use of antibiotics as a preventive measure is definitely not recommended. The abuse of antiparasitic drugs, especially of sulpha drugs, does far more harm than good. All drugs, at a cer-

tain dose, are poisons and must be used with caution.

*Disinfecting.* The literature covers this topic extensively, so the following will be brief. Disinfecting the rabbitry should be a routine matter, following some simple rules regarding cleanliness, dryness and disinfection. Dirty equipment cannot be disinfected. It must be washed first or, if water is short, carefully scraped and brushed. It must then be thoroughly dried as a first step towards disinfecting equipment. It should not be forgotten in this context that sun-drying well-cleaned equipment for several days is a simple, cost-free and very efficient means of disinfecting. The only preconditions are a storage area off limits to domestic animals and a reserve supply of extra equipment so that cleaning and disinfecting time will not cut into production time. In industrial production, pressurized steam-cleaning equipment is indispensable.

#### **Occasional measure: sanitary isolation**

No matter what precautions are taken, after one, two or three years health problems will become less and less easy to control. Imperceptibly, productivity will decrease despite an increase in hygiene and care and in the experience of the breeder. This has to do with the buildup of bacterial contamination in the rabbitry, coupled with the irreversible presence of harmful microflora and microfauna in the animals.

Sanitary isolation becomes essential at this point. All rabbits in the affected section of the rabbitry must be culled. All equipment must be cleaned, repaired and disinfected. After this is done the area must be left vacant for some time (one or two weeks) before introducing new rabbits. Some small farm rabbitries have two premises which they alternate every year. This is a kind of one-year sanitary isolation which has proved very effective.

# Colour plates



Foto Saleh

1  
*New Zealand White rabbit*

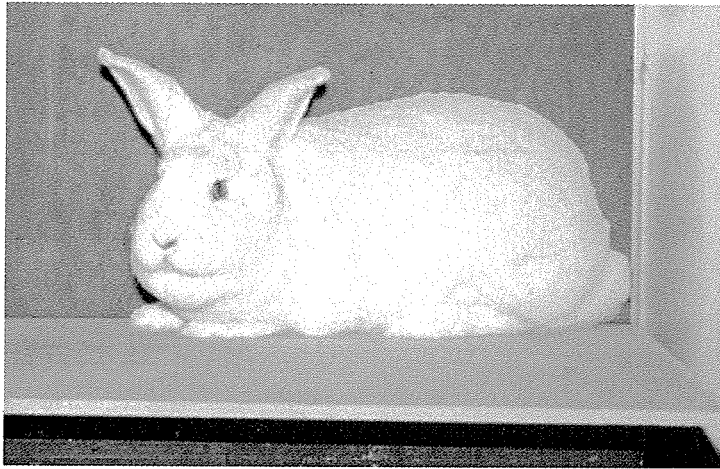

Foto Saleh

2  
*Bouscat Giant White rabbit*

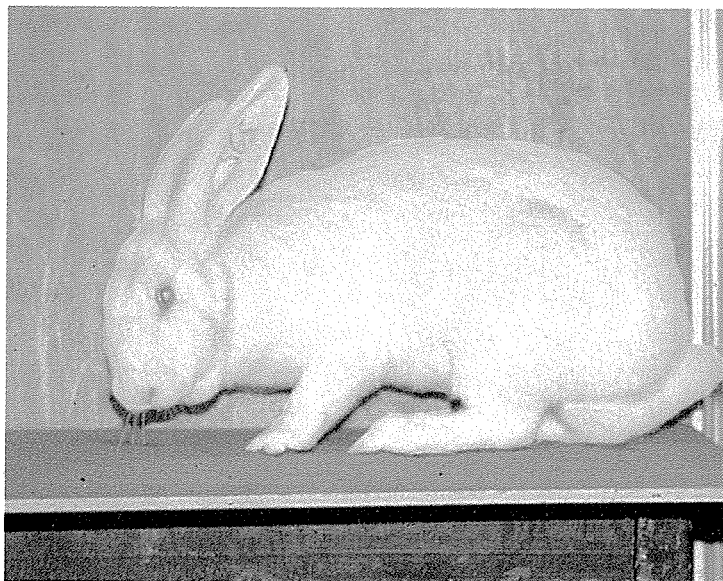

Foto Salei

3  
*French Belier rabbit*

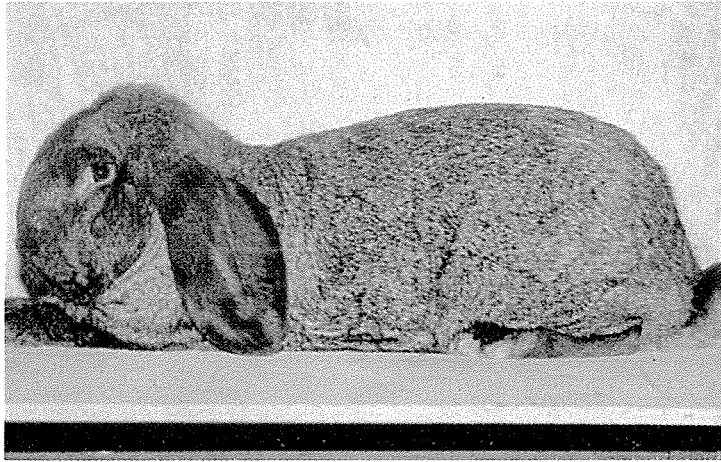

Foto Salei

4  
*Californian rabbit*

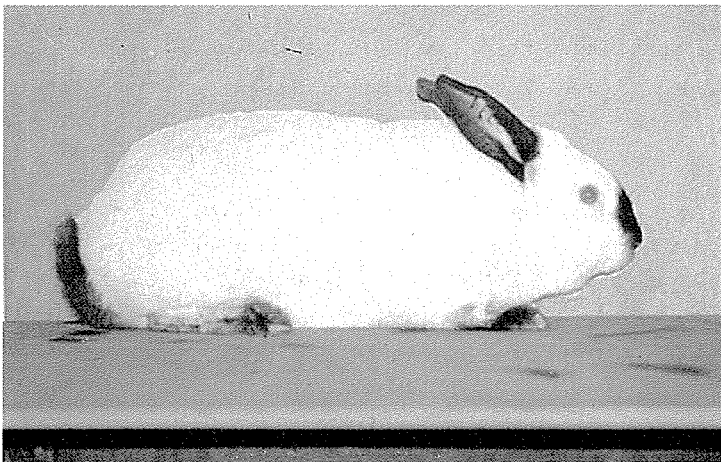

Foto Salei!

5  
*Dutch Belted rabbit*

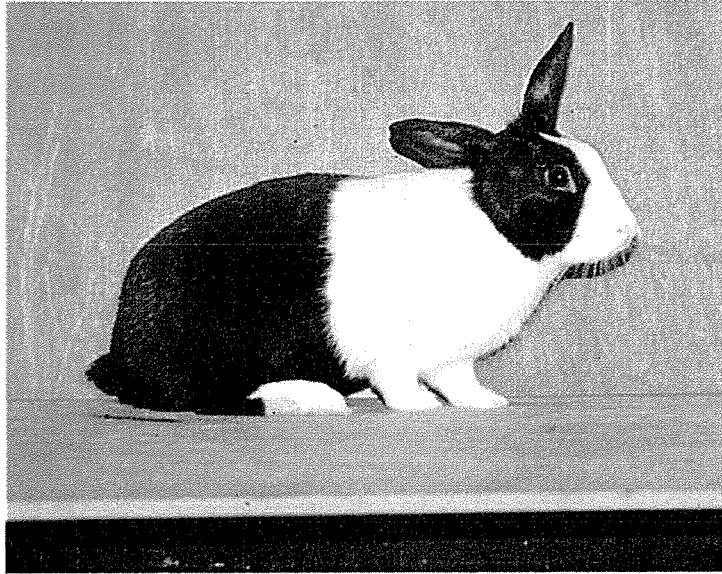

Foto Salei!

6  
*French Giant Papillon rabbit*



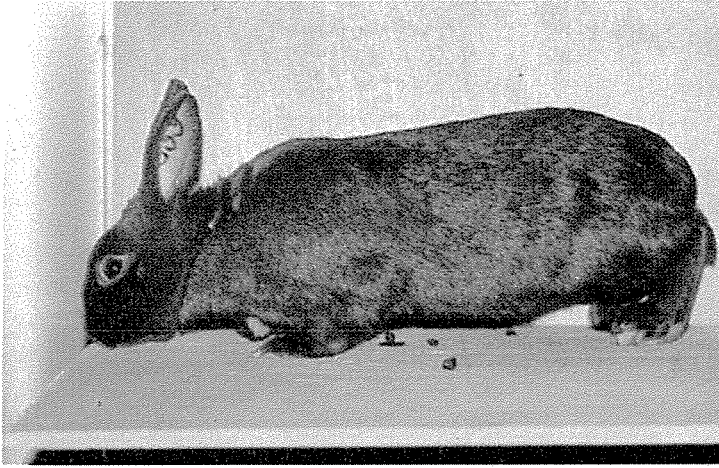

7  
*Vienna Blue  
rabbit*

Foto Salei

8  
*Flemish Giant  
rabbit*



Foto Weber



9  
*Creole  
(Guadeloupe)  
rabbits*

Foto Lebas

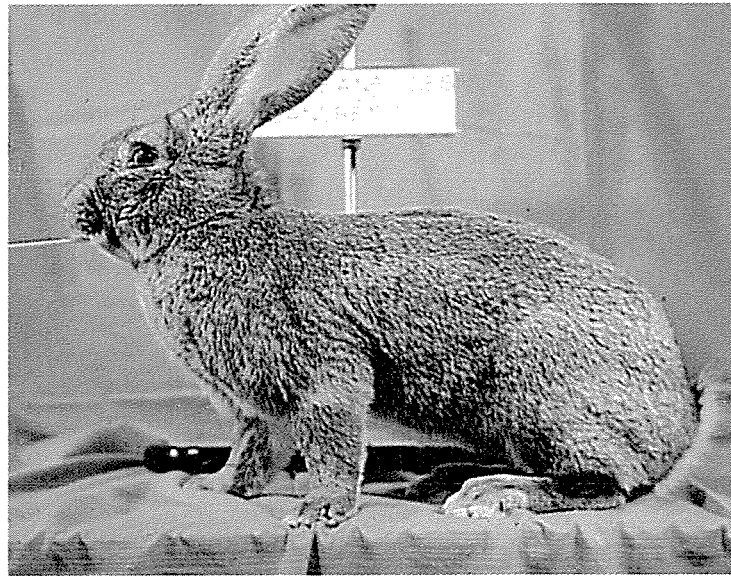

10

*A "family package" of bucks and breeding does supplied by a Mexican programme*



11

*Wooden hutches with mesh floors arranged in a two-storey system (Guadeloupe)*



Foto Lebas

12  
*Open drinkers supplied semi-automatically from a fitted bucket (Guadeloupe)*

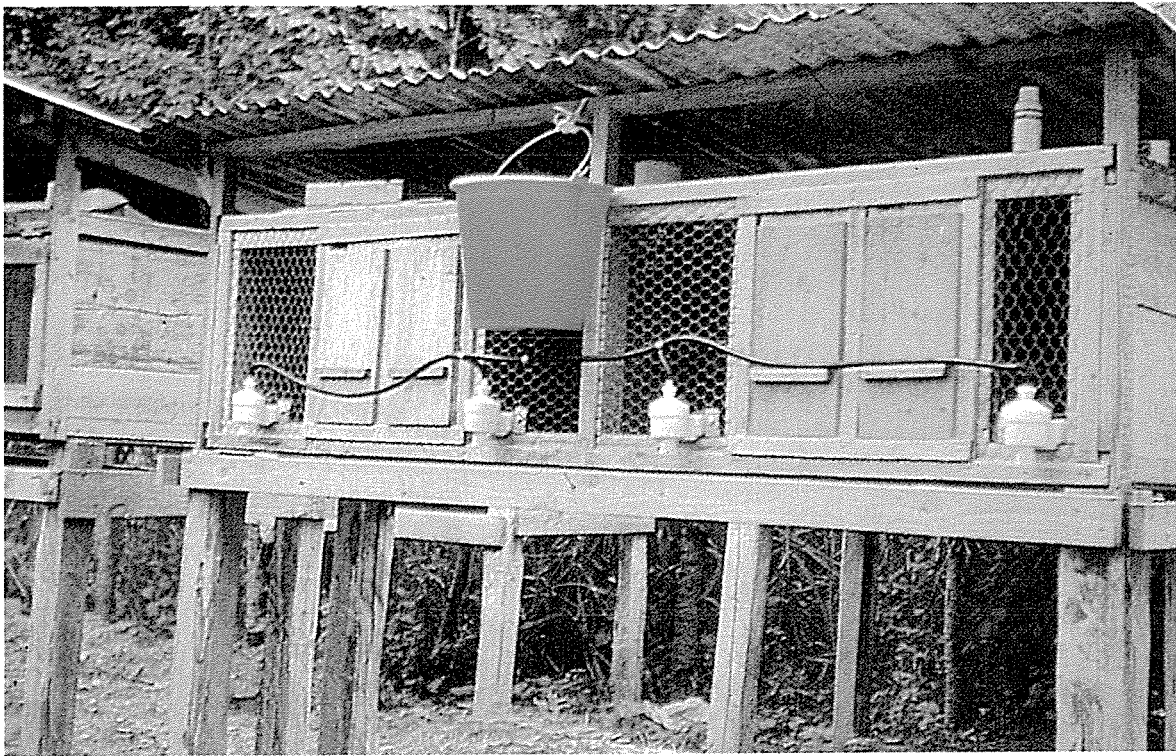

13  
*Fattening cages built entirely in wire mesh, placed outside in superimposed rows (France)*

Foto Lebas



Foto Labas

14  
*Cages arranged in a plastic greenhouse, protected with a reed lattice (France)*

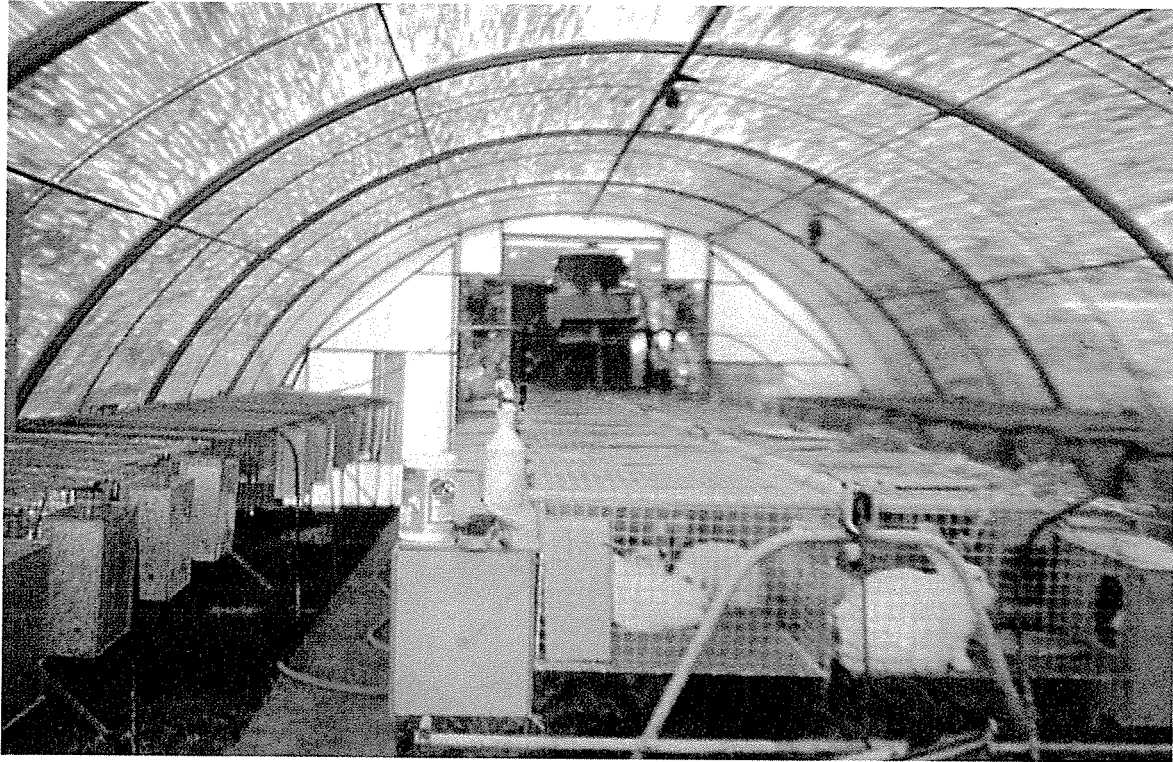

Foto Tudela

15  
*Exterior of the same greenhouse, photographed in winter*

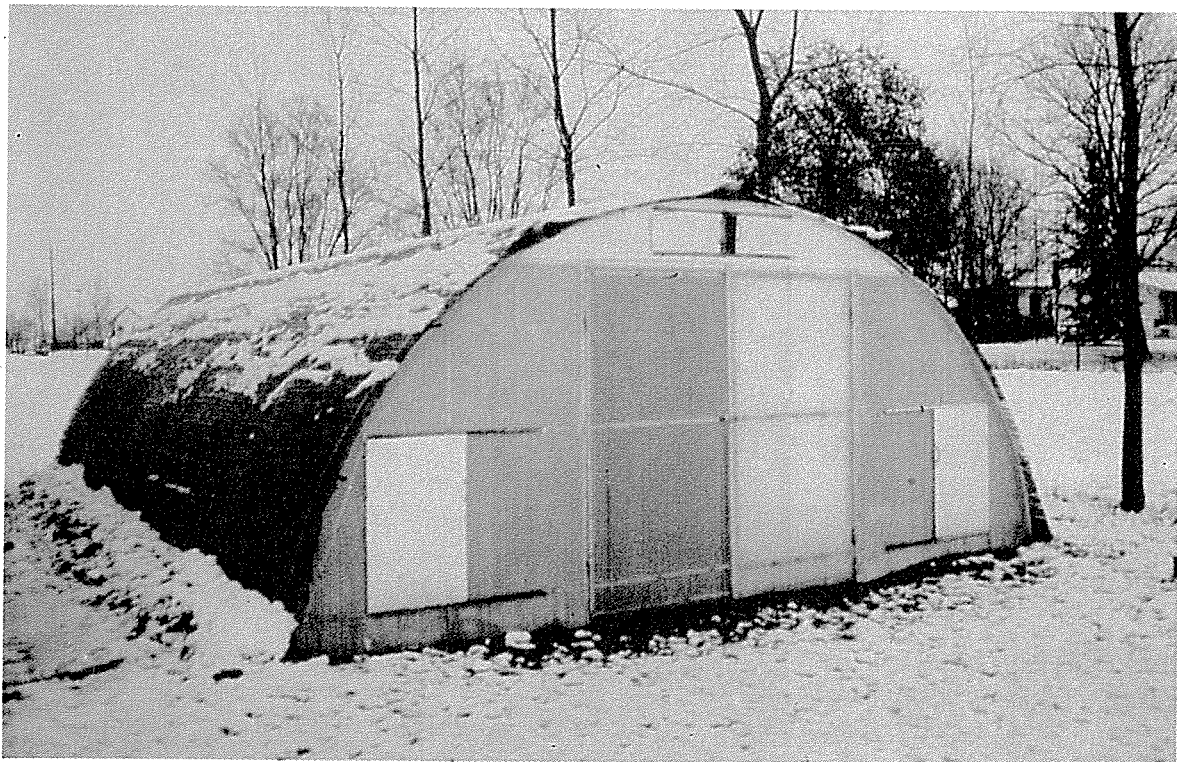

Foto Saleh INRA

16

*Fattening cages for rabbits in a greenhouse with a makeshift floor*

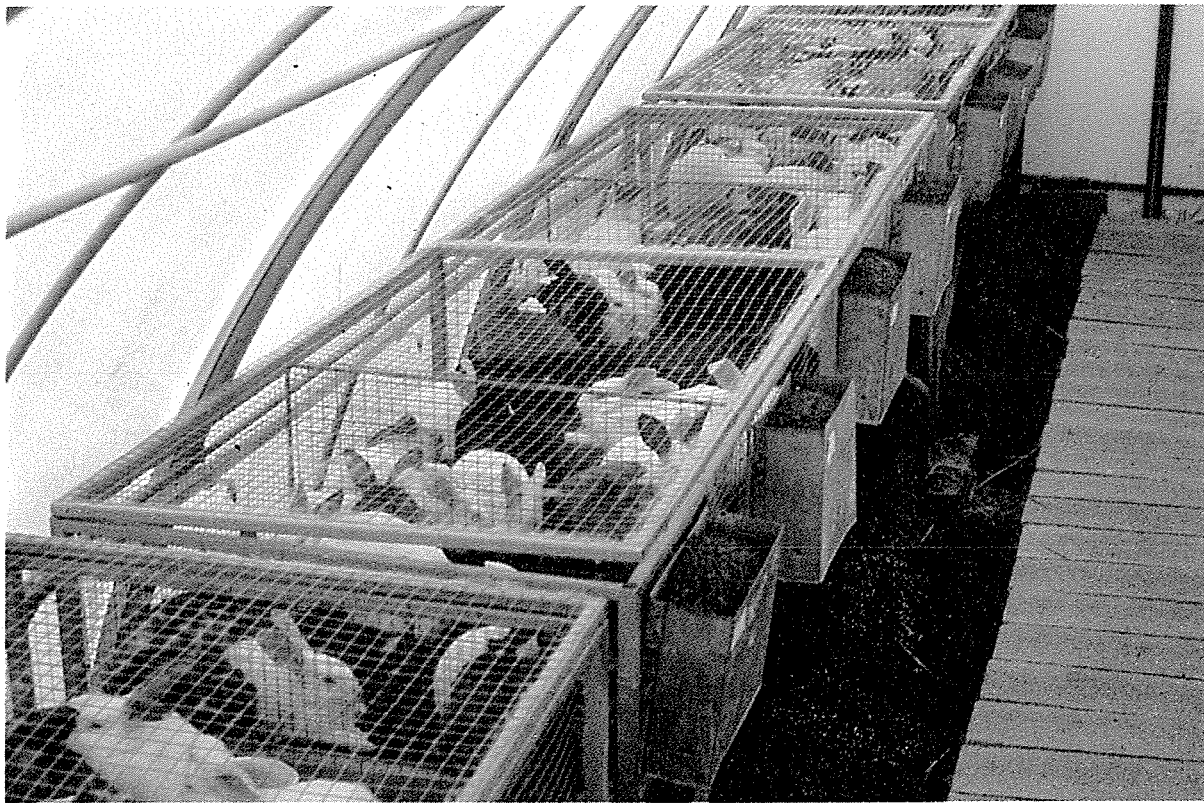

Foto Lebas

17  
*Italian system for arrangement of fattening cages*



Foto Lebas

18  
*Mesh cages arranged by the Californian system (France)*



Foto Cuniculture

19

*Breeding cages with forward nest box in a modern French rabbitry*



Foto Lebas

20

*Cages for the collection  
and transport of rabbits  
to the abattoir (Hungary)*



Foto Cuniculture

21

*Plastic cages for trucking rabbits  
from the rabbitry to the abattoir*



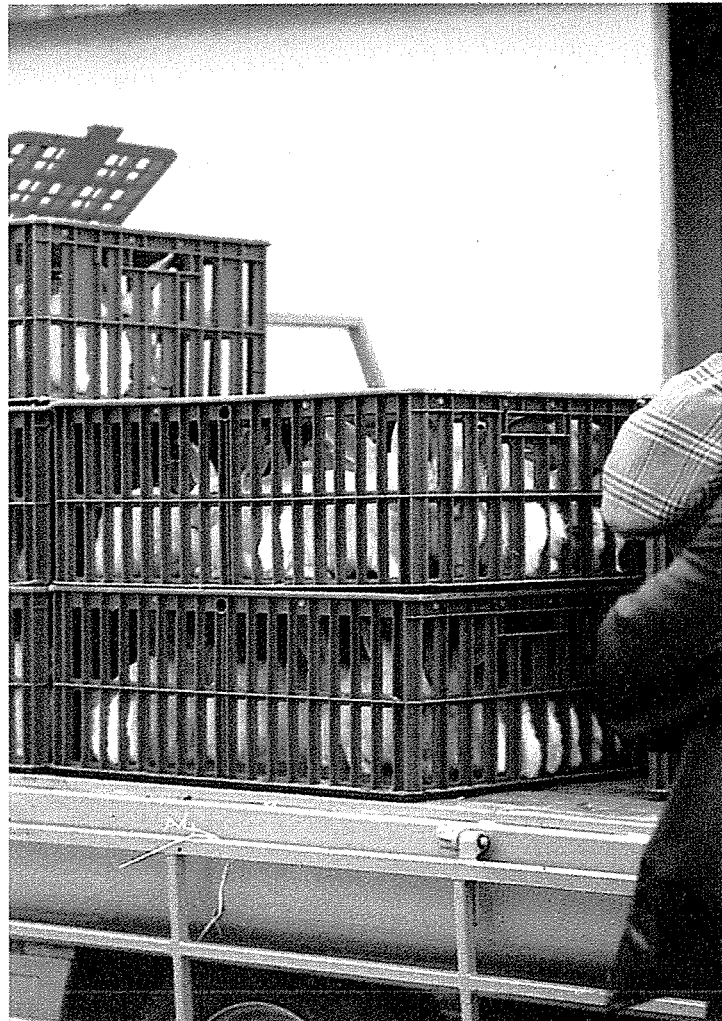

Foto Solambe

22

*Rabbitry in Cameroon. Recycling cages for laying hens in a semi-Californian arrangement*



Foto Solambe

23

*Health-care room at the Solambé Demonstration Centre, Yaoundé, Cameroon*

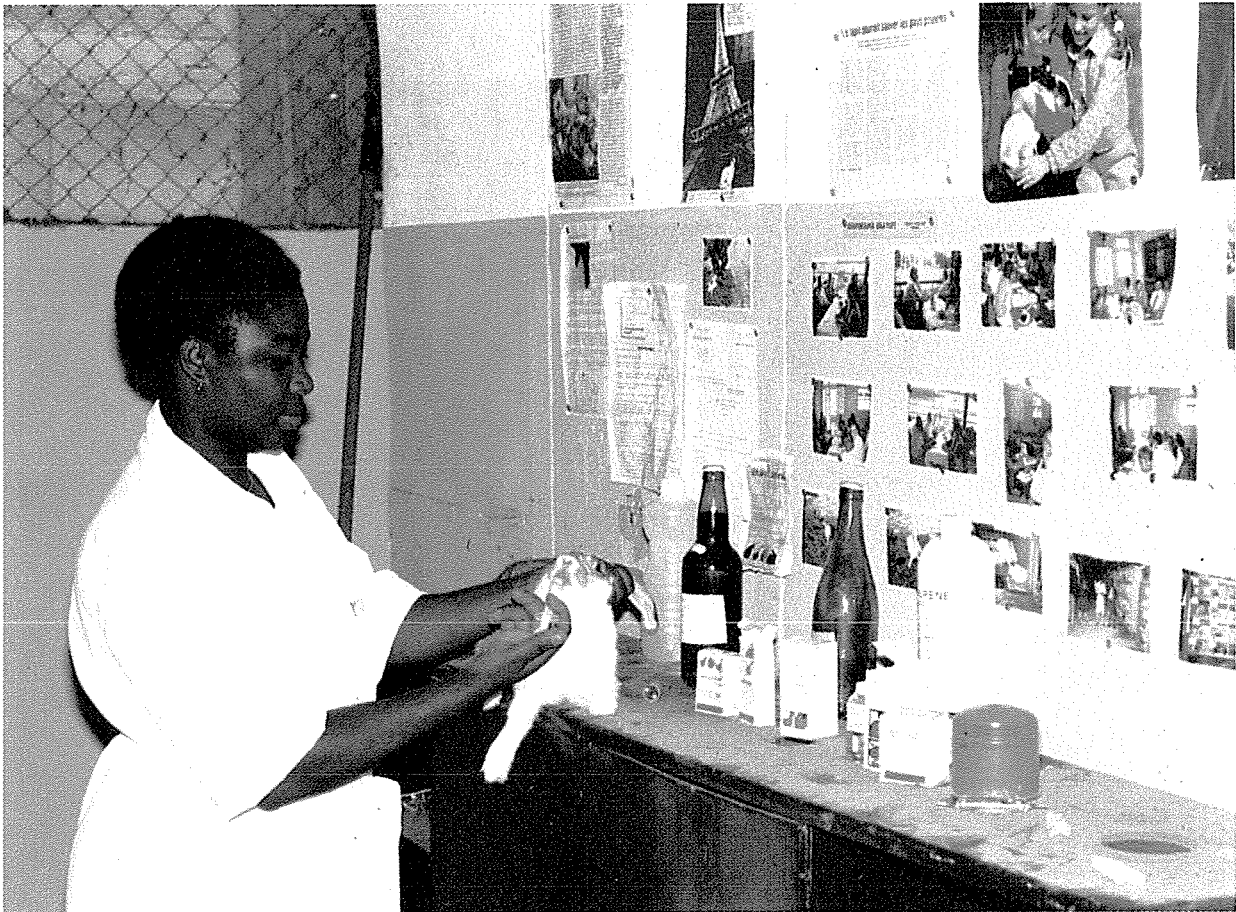

Foto Finzi

24  
*Rabbitry with semi-underground cages: overall view*

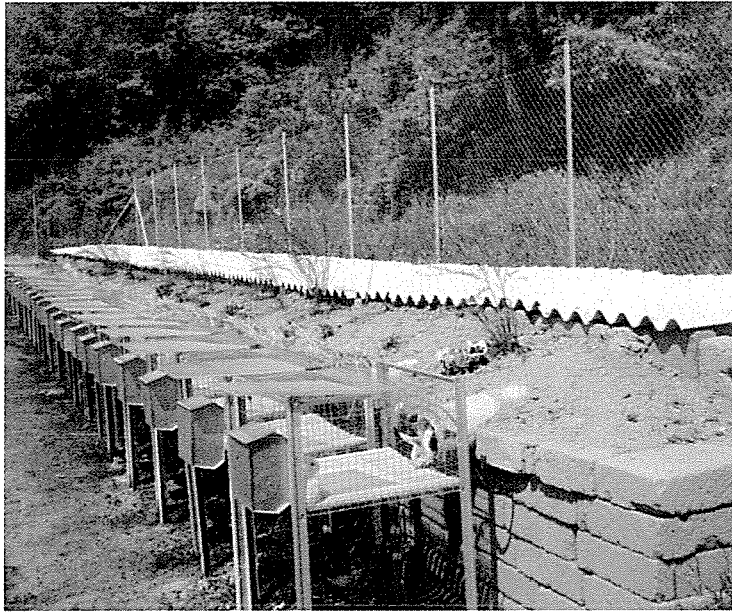

Foto Finzi

25  
*Rabbitry with semi-underground cages: unit*

26  
*Faeces from rabbits receiving feed with a normal proportion of roughage, slightly deficient and deficient in roughage but without diarrhoea*

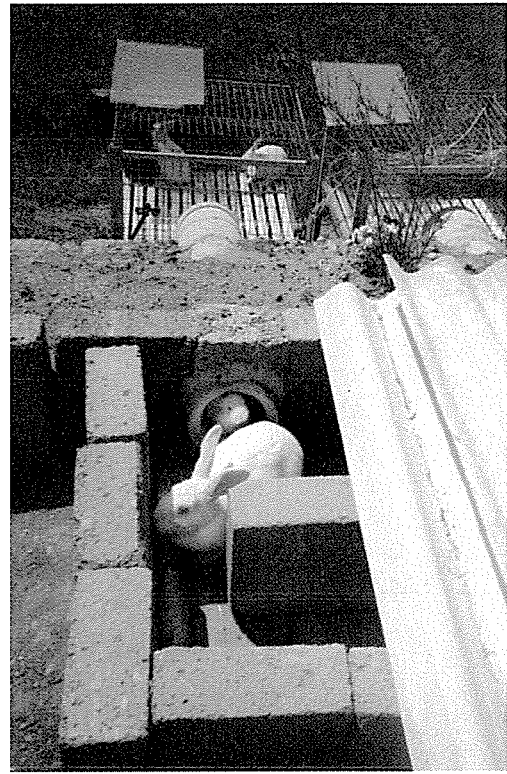

Foto Colin



## Chapter 6

# Housing and equipment

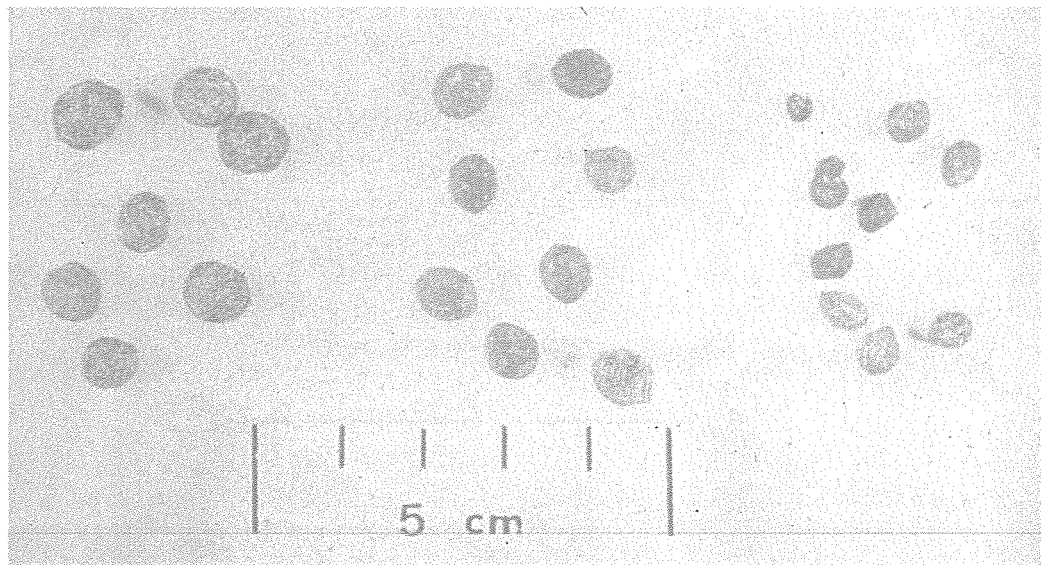
### BIOLOGICAL CONSIDERATIONS

The design of rabbit housing is governed by the behavioural characteristics of the animals and their reactions to environmental temperature and humidity.

#### Rabbit behaviour

Some kinds of behaviour have already been analysed in this book and others have been mentioned briefly. They all have an influence on rabbit housing so they will be summarized at this point. Since the domestication of the rabbit is recent in terms of species evolution (200 to 300 generations at most) the behaviour of the domestic rabbit is still much like that of the wild rabbit. The reactions of wild rabbits will often provide explanations for the problems of housing domestic rabbits and suggest ways of solving them.

**Territorial behaviour.** Wild rabbits live in sedentary fashion in a territory the size of which depends on the conditions of food supply. They mark their territory, their fellows and their offspring with the aid of a gland found in hair follicles under the chin. The bucks also mark off their territory with their urine. The rabbits dig burrows in which they take shelter at the slightest sign of warning. There they live in a "society". Before parturition, however, the doe digs a special burrow where her young are born and where she returns once a day to nurse them.

This is why domestic rabbits should have durable living quarters, providing either a refuge from disturbances or a peaceful environment that makes a refuge unnecessary. Any new and sudden change (noise,

presence, smell) will make the first rabbit in the group to notice the disquieting novelty thump his hind foot to warn his fellows of danger. To prevent panic in the rabbitry the breeder should take care that changes that might upset the animals are avoided.

When a rabbit is put in a new cage he will explore it and then mark it with his smell. The more strange odours there are in the cage the longer this task will take.

The burrow is not only a refuge in case of alert, it is also a rest area during the day, as rabbits are mostly nocturnal. Temperature and humidity are far more constant in the burrow than outside.

**Social behaviour.** Wild rabbits live in colonies in which females outnumber males. Each female, with or without offspring, attacks the young of other does. Bucks act as moderators at this stage. When the young males reach puberty, however, the adult males try to eliminate them as rivals by castrating them.

The method used in rational European rabbit production to prevent such conflicts is to isolate each adult rabbit in an individual cage. Before puberty, young rabbits can be reared in groups. Attempts to rear breeding animals in groups are bound to fail because the does are so aggressive towards the young, especially when the animals' living space is cramped. Females without young can be reared in groups provided each female has at least half a square metre of space for herself.

**Sexual behaviour.** Ovulation in the does is brought on by mating (see Chapter 3, Reproduction), so one might expect mating to

be possible on a quasi-permanent basis. In fact, does do have a behavioural cycle of acceptance of the male but unfortunately this varies greatly from one doe to the next. Attempts at servicing often have to be repeated, which means the animals must be moved about a great deal.

The buck is so very territorial that when he is put in a female's cage his first act is to mark this new territory with his smell, while the doe tries to eliminate the intruder. But if a doe is put in a buck's cage the immediate reaction of both animals is sexual. For a receptive doe preparation for mating takes 20 to 120 seconds, and the act itself less than a second. For servicing, therefore, it is the doe that should be moved. This is relatively easy because does are calmer and weigh less than bucks (3 to 6 kg). For mating to be supervised, the animals need to be visible in all parts of the cage. Access to the buck's cage should be simple so that the does can be easily introduced and removed.

With this kind of mating, people have to move the animals physically within the rabbitry and this will influence the planning of the general layout of the unit to limit the distances to be covered. The rather unsatisfactory results obtained with special cages reserved for mating should be mentioned. Many males waste a lot of time marking a mating cage that is impregnated with the smell of their predecessor, and the cage is also a possible site for the spread of diseases.

**Maternal behaviour.** Before kindling, the doe makes a nest with various materials plus fur that she pulls from her abdomen. The wild doe's nest is made at the end of the private burrow she digs for kindling. The domestic rabbit does not usually have the opportunity to do this, so a private area should be set apart for her. In farm rabbitries using straw litter the doe might be satisfied to dig into the straw to make a nest. But producers have noticed that it is

preferable to provide her with a nest box that approximates the natural burrow.

A box like this is useful in a farm rabbitry and essential in wire cage production. After the young are born (six to 12 per litter), the doe nurses them once every 24 hours for about a month. To allow the motor coordination and heat-regulation capacity of the baby rabbits to develop, the nesting box should be maintained for at least two weeks. It should be big enough to accommodate the doe and her litter during nursing.

**Feeding behaviour.** Laboratory research has shown that rabbits will drink and eat at any time in the 24 hours, although they tend to feed nocturnally. Intake is rather slow, even if the animals' feed is rationed. Feed and water should therefore be available over periods of several hours, whether feed is rationed or ad lib. The feed must not be allowed to get dirty, which is inevitable if it is strewn on the ground (see Chapter 5, Pathology).

From the age of three weeks young rabbits begin to eat the same feed as the doe. Their small size allows them to slip easily into forage racks or dry feed hoppers, so this equipment must be designed to keep them out.

Practically speaking, these features mean that the breeder must provide a drinker and feeding rack for each cage, and perhaps a fodder rack. The animal must be able to reach the feeders and fodder racks, as must the caretaker to top them up frequently. An automatic or semi-automatic drinker is easy to make, however. These constraints mean that solid feed distributors are almost always placed in front of the cages, which can easily hinder visibility and accessibility.

#### **Hygiene, habitat and breeds**

There would be no point in reiterating here all the rules of hygiene dealt with in other

chapters, particularly preventive hygiene. However, the design of the rabbitry will be heavily influenced by some of these rules.

One of the major rabbit diseases in traditional small-scale production using straw litter is coccidiosis. Contamination is via oocysts eliminated with the faeces. Breeders have cut the incidence of this disease by using wire-mesh floors through which the excrement drops.

The wire-mesh flooring system, combined more recently with single, portable, interchangeable cages, has led to considerable progress in disinfecting equipment. Some diseases have been cut down or even wholly eliminated. But not all rabbit breeds can adapt to this type of flooring. Heavy or nervous breeds, in particular, are subject to sore hocks, a bacterial infection developing on the foot pads and irritated by the wire mesh (too much weight per cm<sup>2</sup>). The risk is greater when the animals are raised in environments with high temperatures (31° to 32°C), or very high humidity (constant relative humidity above 85 percent), or when the rabbits are frequently under stress and thus thump their hind feet on the ground to warn the other rabbits of impending danger. A mesh floor also cannot be insulated, and rabbits are more liable to respiratory ailments if air flow is not controlled.

Breeders therefore have to make a decision: either they rear New Zealand White or Californian breeds, which have been adapted to mesh flooring, and thus meet modern hygiene standards, or else they rear heavier or more excitable breeds – but then how do they control coccidiosis and other diseases?

As well as these hygiene-linked problems there are other advantages and disadvantages with both mesh floors and traditional straw litter. With a mesh floor, through which droppings can fall, automated or very infrequent cleaning is possible because droppings accumulate under the cage). But it also makes the rabbits very

dependent on the microclimate or ventilation in the rabbitry. Straw litter, on the other hand, has to be cleaned often (at least once a week) so the producer has to have the material on hand (straw, wood shavings, etc.). An advantage is that a cage with a straw litter floor can be put almost anywhere, as the cage itself partly insulates the animals from variations in the external climate.

In Europe today most new production units use solely wire-mesh cages and New Zealand White or Californian rabbits. But this implies doing without the genetic pool of other breeds. Would it not be possible to design other types of flooring, recognizing that slatted floors have never been very satisfactory? Whatever the answer, for many developing countries the wire-mesh cage will probably remain a theoretical solution for many years to come, until the special mesh necessary is made available to producers at reasonable prices.

### Environment

**Temperature.** Temperature is the most important factor as it directly affects a number of elements. Rabbits have a constant internal (rectal) temperature so heat production and losses must vary to maintain body temperature (Table 49). They do this by modifying their feed intake level (regulating production), as described in the chapter on nutrition. They use three devices to modify heat loss: general body position, breathing rate and peripheral temperature, especially ear temperature (Table 49).

If the ambient temperature is low (below 10°C) the animals curl up to minimize the total area losing heat and lower their ear temperature. If the temperature is high (above 25° to 30°C), the animals stretch out so they can lose as much heat as possible by radiation and convection, and step up their ear temperature. The ears function like a car radiator. The efficiency of the cooling system depends on the air speed around the

TABLE 49  
Exportation of heat, rectal temperature and ear temperature in adult New Zealand White rabbits, according to ambient temperature

Ambient temperature (°C)	Total release of heat (W/kg)	Release of latent heat (W/kg)	Body temperature (°C)	Ear temperature (°C)
5	5.3 ± 0.93	0.54 ± 0.16	39.3 ± 0.3	9.6 ± 1.0
10	4.5 ± 0.84	0.57 ± 0.15	39.2 ± 0.2	14.1 ± 0.8
15	3.7 ± 0.78	0.58 ± 0.17	39.1 ± 0.1	18.7 ± 0.6
20	3.5 ± 0.76	0.79 ± 0.22	39.0 ± 0.3	23.2 ± 0.9
25	3.2 ± 0.32	1.01 ± 0.23	39.1 ± 0.4	30.2 ± 2.5
30	3.1 ± 0.35	1.26 ± 0.38	39.1 ± 0.3	37.2 ± 0.7
35	3.7 ± 0.35	2.00 ± 0.38	40.5 ± 0.8	39.4 ± 0.47

Source: Gonzales, Kluger and Hardy, 1971.

animal. At the same time the animal pants to increase heat loss through evaporation of water (latent heat). The sweat glands are not functional in rabbits and the only controlled means of latent heat evacuation is by altering the breathing rate. Perspiration (the evacuation of water through skin) is never great because of the fur.

These systems work between 0° and 30°C but when ambient temperatures reach (and mainly when they exceed) 35°C rabbits can no longer regulate their internal temperature and hyperthermia sets in.

The regulation methods described above, based on observations of adult animals, are applicable to young rabbits from the age of about one month, when they can move about and feed themselves and the juvenile coat has grown. Heat regulation of newborn rabbits is somewhat different: they have no fur and cannot correctly adjust their food intake as the doe's milk output is the result of an involuntary reaction. At birth they have rather good fat reserves which help them maintain body temperature if two conditions are met. The surrounding temperature must be at least 28°C (30° to 32°C if possible), and they must have other young to huddle against to reduce heat loss.

At birth, young rabbits cannot modify their body shape by curling up. The only way they can limit heat loss through convection and radiation is to huddle together with the other young in the litter. In fact, if ambient temperature varies during the day the young rabbits will move apart when the temperature is high and huddle back together when it goes down. But a sudden temperature drop may well exhaust their thermoregulation potential before they can get back in the huddle and they can die of cold 10 cm away from the group. The newborn rabbit is blind and the incomplete myelination of the nervous system that governs motor control hampers coordinated movement. The producer must make sure the temperature in the nest remains constant to prevent this sort of accident.

**Humidity.** Rabbits are sensitive to very low humidity (below 55 percent) but not to very high humidity. This may be explained by the fact that wild rabbits spend much of their lives in underground burrows with a humidity level near saturation point (100 percent).

The rabbit has more to fear from abrupt changes in humidity. Constant humidity is



therefore the best solution, and this will depend on the housing design. French breeders find 60 to 65 percent humidity levels successful, using only auxiliary heating in winter.

While the humidity level does not seem to trouble the rabbit in moderate temperatures, this is not so with temperature extremes.

When the temperature is too high (close to the rabbit's body temperature) and humidity is also high, not much latent heat can be exported as water vapour through evaporation. The result is discomfort which can be followed by prostration. Very hot spells with near 100 percent humidity can cause serious problems. Unfortunately this is common in tropical climates during the rainy season.

When the temperature is too low and humidity close to saturation point, water condenses on poorly insulated walls, especially at so-called "heat bridges". Water is a good heat conductor and so the cold becomes more penetrating, causing heat loss in the animals through convection and conduction. Digestive and respiratory disorders often follow. When the surrounding air is cold, excess humidity modifies the secretion and viscosity of the mucus protecting the upper respiratory apparatus.

Air which is too dry (below 60 percent relative humidity) and too hot is even more dangerous. Not only does it upset the secretion of mucus but the ensuing evaporation shrinks the size of the droplets carrying infection agents, enabling them to penetrate more easily the respiratory apparatus.

**Ventilation.** The rabbitry must have a certain minimum of ventilation to evacuate the harmful gases given off by the rabbits ( $\text{CO}_2$ ), to renew the oxygen and get rid of excess humidity (evaporation, exhalation) and excess heat given off by the rabbits.

Ventilation needs can vary enormously,

depending especially on climate, cage type and population density. Ventilation standards for temperate climates based on several French studies are given in Table 50. This table combines the various parameters (temperature, air flow, humidity) to determine optimum air flow per kg of rabbit live weight. If there is an imbalance, especially between air flow and temperature, accidents like those illustrated in Figure 24 occur.

It is relatively easy and cheap to measure temperature and humidity, but exact air flow measurement requires sophisticated, expensive, hard-to-get equipment such as a hot-wire anemometer (a revolving-cup anemometer is not sensitive enough). However, the producer can estimate the rate of air flow near rabbits by using a candle flame, as shown in Figure 25.

High ammonia air levels, 20 to 30 parts per million (ppm), greatly weaken the rabbits' upper respiratory tract and open the door to bacteria such as *pasteurella* and *bordetella*. To keep  $\text{NH}_3$  levels down, ventilation can be increased. The risk is then overventilation, with all the negative consequences illustrated in Figure 24. A more effective solution is to limit  $\text{NH}_3$  production from fermenting floor litter (droppings and urine) by removing the litter quickly or keeping it dry. The maximum permissible  $\text{NH}_3$  content in the air rabbits breathe is 5 ppm.

### Lighting

Few studies have been made on the influence of light on rabbits, and these are almost exclusively concerned with the duration of lighting and seldom with light intensity. Furthermore, practical recommendations on lighting are based more on observations in rabbitries than on experimental findings.

Exposure to light for eight out of 24 hours favours spermatogenesis and sexual activity in bucks. Conversely, exposure for 14 to

TABLE 50  
Ventilation standards in France for enclosed rabbitries

Temperature (°C)	Humidity (%)	Air speed (m/sec)	Air flow (m <sup>3</sup> /h/kg live weight)
12-15	60-65	0.10-0.15	1 – 1.5
16-18	70-75	0.15-0.20	2 – 2.5
19-22	75-80	0.20-0.30	3 – 3.5
23-25	80	0.30-0.40	3.5 – 4

Source: Morisse, 1981.

16 hours a day favours female sexual activity and fertilization. In rational European production all breeding animals of both sexes get 16 hours of light. The slight drop in male sexual activity is amply compensated by good female reproduction rates (acceptance of the male and fertilization).

Performance is more constant in windowless rabbitries with artificial lighting than in rabbitries which supplement sunlight by artificial lighting. Twenty-four-hour light trials caused reproduction disturbances in rabbits. It therefore seems best to limit the duration to 16 hours.

Observations from different rabbitries indicate that breeding does need considerable luminosity, at least 30 to 40 lux. In fact, many breeders who light their premises for 16 hours a day but not uniformly find that the does receiving the least light have the worst reproduction performance. When light distribution is made uniform, reproduction performance picks up.

In European rabbitries lighting is provided by incandescent lamps or fluorescent tubes (neon daylight type). The latter provide the necessary lux at a lower energy cost than incandescent lamps, but their installation cost is much higher. For flat-deck units the power consumption is 3 to 5 watts per square metre with light sources located no more than three metres from the animals.

Very young rabbits do not really need light, but 15 to 16 hours per day do no harm.

Twenty-four-hour lighting, however, can cause disturbances which are hard to explain, such as diarrhoea unrelated to changes in the rate of caecotrophy. So breeders use either sunlight (in rabbitries with windows) or artificial lighting for one or two hours a day to satisfy the young rabbits' needs, at a set time so as not to disturb caecotrophic behaviour. A much weaker light (5 to 10 lux) can be used for young rabbits.

#### RABBITRY EQUIPMENT

Equipment in direct contact with the rabbits or their excrement becomes contaminated by the bacteria, viruses and fungi that accompany the animals. Cages, fittings and building walls must be designed so they can be easily cleaned, disinfected or replaced and not in turn become sources of contamination.

Portable components which can be cleaned outside the rabbitry building are especially recommended. Away from the rabbits stronger cleaning agents and more effective methods can be used – powerful disinfectants, lengthy soaking, prolonged exposure to the sun's rays.

Some materials are easier to disinfect than others. Wood is very hard to clean, but it can be periodically replaced in countries where it is plentiful. Plywood can be disinfected by steeping it in disinfectant solutions. Galvanized iron is easy to clean and disinfect but, unlike wood, is a poor insulator. Concrete, provided it is smooth, can be cleaned and

FIGURE 24  
Effect of air speed ( $V$ ) and temperature ( $T^\circ$ ) on health of rabbits

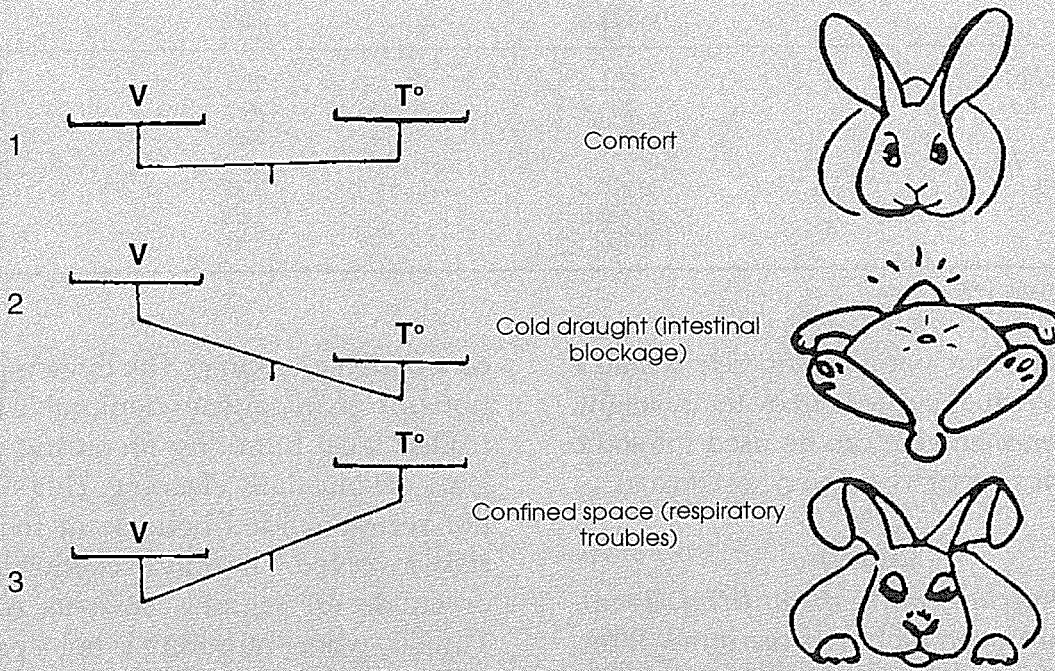

Source: Morisse, 1981.

FIGURE 25  
Estimating air flow with a candle flame

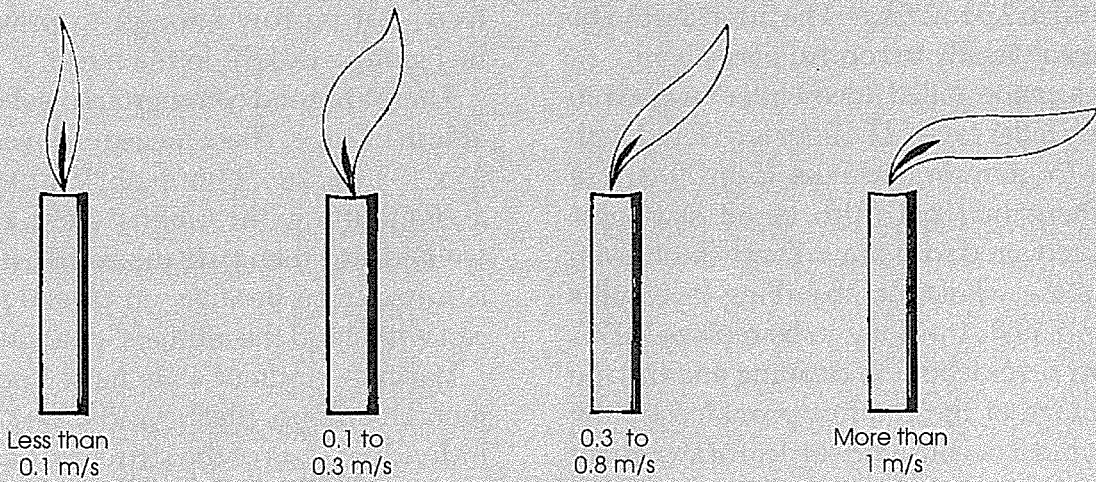

Source: Le Ménéec, 1982.

TABLE 51  
Brightness of various types of lighting

Lighting	Electric power (wattage)	Luminosity (lux)
Incandescent	25	250
	40	490
	60	829
Fluorescent	20/32	750
	25/32	1 140
	40/32	1 880

Source: Yamani, 1992.

disinfected, but portable concrete installations are virtually ruled out by their weight. Glazed earthenware can be used for some accessories (troughs, or even nest boxes).

### Caging

**Cages (hutches) with straw litter.** Traditional European rabbitries use straw litter. This material can be replaced by any other dry fibrous product which is not rough to the touch (soft shavings, hay, industrial cotton waste and so on). The cages are either of concrete (lasting 15 to 30 years) or wood (lasting not more than two years). Cages for breeding animals usually have at least a 60 to 70 cm x 80 to 100 cm floor space and are 50 to 60 cm high. Identical cages are often used for fattening five or six young rabbits (to 2.5 to 2.8 kg). The litter should be replaced weekly to control parasitism.

A variation called "deep litter" is used in slightly taller cages. The floor is covered with a bed (minimum thickness 15 to 20 cm) of absorbent material (turf, wood shavings) evenly covered with straw. Every six or seven weeks the whole lot, absorbing layer plus accumulated straw, has to be replaced. This system saves labour in cleaning and has the advantage of the comfort provided by the straw, but it does use a great deal of absorbent material so it is only applicable where this material is both readily available and cheap.

**Cages without litter.** In some regions rabbits are raised on litterless floors (hard earth

or wooden planking). The hygienic conditions are nearly always deplorable (uncontrolled local humidity favouring parasitism), despite daily cleaning. This system is not recommended because of the health risks involved. The only exception is desert or subdesert regions, such as southern Tunisia, where humidity is not a problem.

The solution to the problem of changing litter has been to separate the animal from its excrement as soon as this is dropped. The rabbits are raised above the ground on a wire-mesh or slatted floor. Wire-mesh floors should be thick enough not to injure the pads of the rabbits' feet (diameter 2.4 mm, minimum 2 mm); the mesh should be wide enough to let the droppings fall through (diameter 1 to 1.3 cm, according to feed) but narrow enough to prevent the feet getting caught in the mesh.

There are good commercial meshes available in Europe. These measure, for example, 25 x 13 mm, 76 x 13 mm or 19 x 19 mm. To avoid injury to the rabbits' feet the wire is welded and then galvanized. Plastic mesh is impractical because no plastic material can withstand the animals' gnawing.

Various kinds of slats have been tried: wood, bamboo, plastic and metal, but the individual slats of the structure have to be spaced about 1.3 to 1.5 cm apart so droppings can fall through. Problems of comfort (slippery slats) and hygiene (materials which cannot be disinfected) are unfortunately very common. Wherever possible,

wire mesh is preferable to slats. If slats are used instead of mesh, bamboo should be preferred to wood if possible. For heavy breeding animals, metal or inflexible plastic slats have been developed by French rabbit equipment manufacturers. While the results are satisfactory, the cost is unhappily much higher than that of wire mesh.

Only lightweight, calm animals or specially selected breeds (New Zealand White, Californian) can be raised entirely on wire-mesh floors. Producers often compromise by raising the male and female breeding animals on litter and the fattening stock on mesh floors. The breeding animals of heavy breeds can be reared on slatted floors and the young on wire mesh; but slatted floors must be cleaned more frequently.

The dimensions of breeding cages without litter used in France are shown in Table 52 (floor generally of wire mesh but sometimes of metal or plastic slats). As may be seen by comparing these figures with the dimensions given earlier for cages using litter, the mesh floor makes it possible to reduce the area of the breeding cages. At the same time the animal density per square metre (fattening animals) can be increased to 16 to 18 on a mesh floor compared with ten on litter. This is because excrement is immediately eliminated, cutting the risk of parasite contamination. Densities exceeding 16 rabbits per square metre can reduce growth in 2.3 to 2.4 kg fattening rabbits (Table 53).

**Cage systems.** Cage systems vary in accessibility, supervision and comfort for the animals, as well as in convenience of waste removal. Straw-litter cages will be examined first. These are either single level (cages with wooden or plywood framework) or built on several levels (concrete cages, with watertight floor beneath straw litter). The principle is generally the same. Access is by a door in the front of the cage, usually made of mesh, or hardwood latticework that must be replaced fairly often. The other walls

have no openings. They must be built in such a way that the rabbits cannot gnaw them. A rabbit cannot chew on a flat wall but will slowly but surely gnaw away any protruding part of the cage. Some examples of proper wood construction are given in Figure 26. Obviously, softwoods can be gnawed more easily than hardwoods.

Litter removal can be made more efficient if the rear walls of the cages are designed to swing out, as shown in Figure 27. The cages in the illustrations were built for a colony of French Angora rabbits (which have to be reared on litter), but can be used by any rabbitry using litter, whether the cages are of concrete, as in Figure 27, or wood.

For cages without litter, mainly cages with wire-mesh floors, the structure is usually in metal or wood (the latter out of reach of the rabbits' teeth). Walls are usually entirely in wire mesh, but this is not obligatory. There are four main systems: flat-deck, Californian, inclined-slope battery and compact battery. Figure 28 illustrates the four systems. All have been used in European rational production, which means that none is perfect. However, producers prefer the flat-deck system because it has the lowest rabbit density, thus alleviating the problems which arise when many animals are reared in the same building. The main characteristics of each system are described below.

*Flat-deck.* In this system the cages are all on one level. They usually open at the top. They can be suspended by chains or set on feet or low walls. Floor litter drops into pits (ranging in depth from 20 cm to 1.5 m). Shallow pits are cleared daily or every two or three days and deep pits every one to three years. The advantages of the flat-deck system are:

- convenient supervision and handling of animals;
- long life for the material used;
- animal and producer comfort;
- no elaborate ventilation system required.

TABLE 52  
Cage sizes for breeding animals in France (in centimetres)

	Front	Depth	Height
Doe's cage with inner nest box	65-70	50	30
Doe's cage with outer nest box	50-60	50	30
Buck's cage	40	50	30
Cage for future breeding animal	30	50	30

Source: Fort and Martin, 1981.

TABLE 53  
Influence of animal density on fattening rabbits

Number of rabbits per m <sup>2</sup>	18.7	15.6	12.5
Live weight at 77 days (g)	2 150 <sup>a</sup>	2 327 <sup>b</sup>	2 384 <sup>b</sup>
Average weight gain (g/day)	32.0 <sup>a</sup>	36.1 <sup>b</sup>	36.5 <sup>b</sup>
Average feed intake (g/day)	111 <sup>a</sup>	122 <sup>b</sup>	122 <sup>b</sup>
Intake index	3.35 <sup>a</sup>	3.39 <sup>a</sup>	3.36 <sup>a</sup>

Note: a,b: on the same line, two values not having the same index letter differ significantly, to the threshold P = 0.05.  
Source: Martin, 1982.

The main drawback is the low animal concentration per square metre of building, which increases the investment per animal housed despite the low-cost cages. However, flat-decks are recommended for nurseries. They could also be used for fattening, but at a higher investment cost per cage. This is usually the only type of housing in European production units now being established or enlarged.

*California cage.* In this system the cages are staggered, one deck higher than the other but not above it. The cages on the lower level open at the top and those on the upper level at the front (poorer access). Floor litter drops beneath the cages and is collected as in the flat-deck system. Advantages of the California system are:

- same advantages as the flat-deck with regard to ventilation;
- slight increase in animal density per square metre of building.

Drawbacks:

- access to upper cages and supervision difficult;

- frame more expensive than flat-deck.

*Inclined-slope battery.* The cages are placed one above the other. Waste slides down ferrocement or metal panels into troughs from which it is removed manually with scrapers or with running water. Cages obviously open at the front. Advantages of the inclined slope are:

- higher animal density;
- reasonable cost, although more expensive than flat-deck.

Drawbacks:

- no matter what material is used for the panels or how steeply they slant, waste does not drop properly and must be periodically raked down;
- high animal density demands careful ventilation;
- access to the cages, supervision and handling of the animals is more difficult.

*Compact batteries.* Waste can be removed by conveyor belt or vats can be installed beneath the cages and emptied by cable-operated scrapers (manual or electric).

FIGURE 26

Examples of correct and incorrect cage assembly, fostering good hygiene and resistance

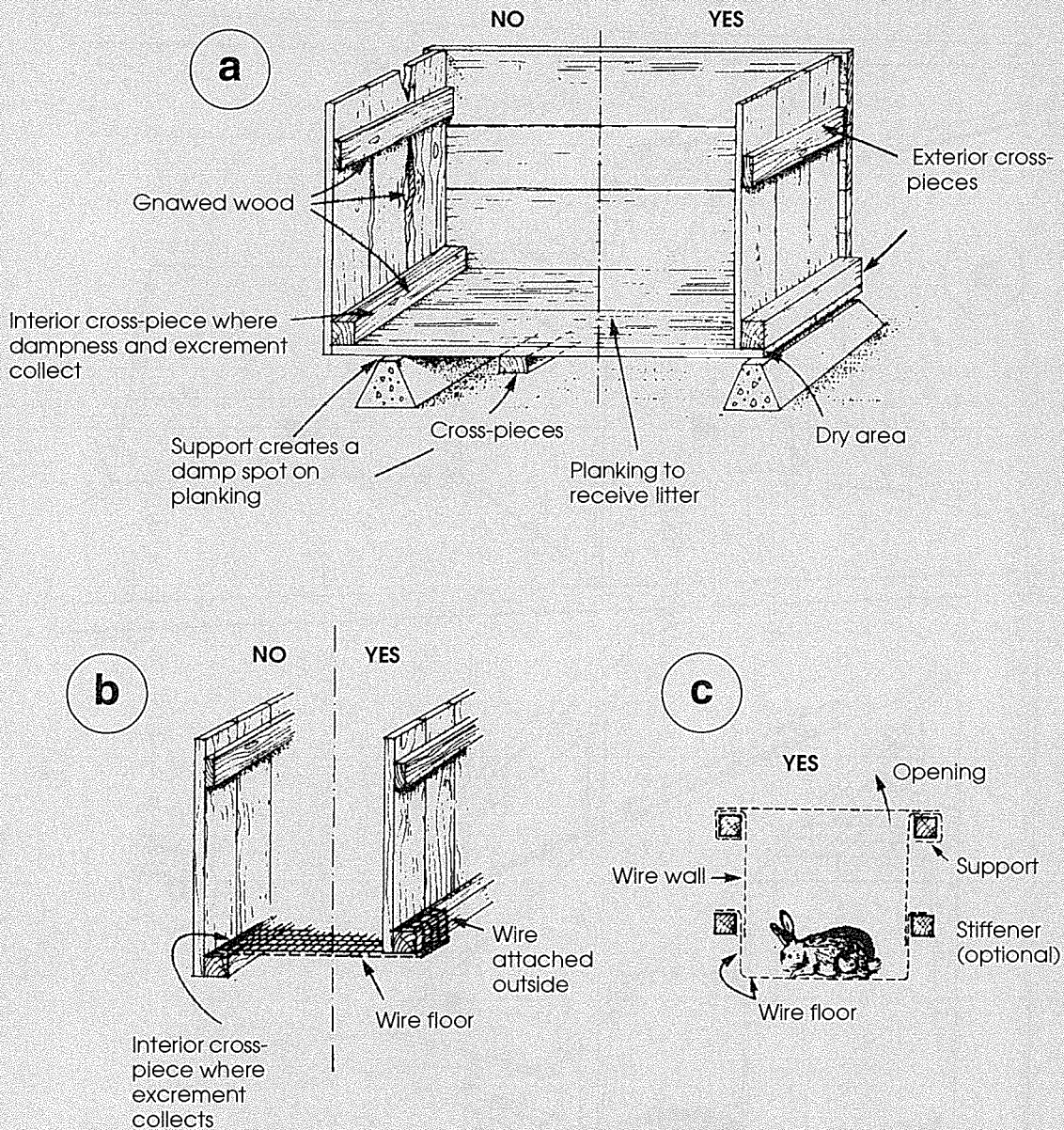

Note: a = wooden cage with litter; b = wooden cage with wire floor; c = suspended wire cage.

As with the inclined-slope battery, the cages must open from the front. The advantage of this system is that the maximum density of animals reduces costs per animal housed.

Drawbacks:

- as for the inclined-slope battery regarding ventilation, access to cages, supervision and handling of animals;
- quicker wear and tear on materials;
- with automatic scraping there is the risk of

breakdown and harmful gases from the scrapers;

- poor distribution of light for breeding does.
- Compact batteries have virtually been abandoned for nurseries in rational European rabbitries.

### Watering

A permanent dispenser of clean water is an essential item in each cage, wherever rabbits

FIGURE 27

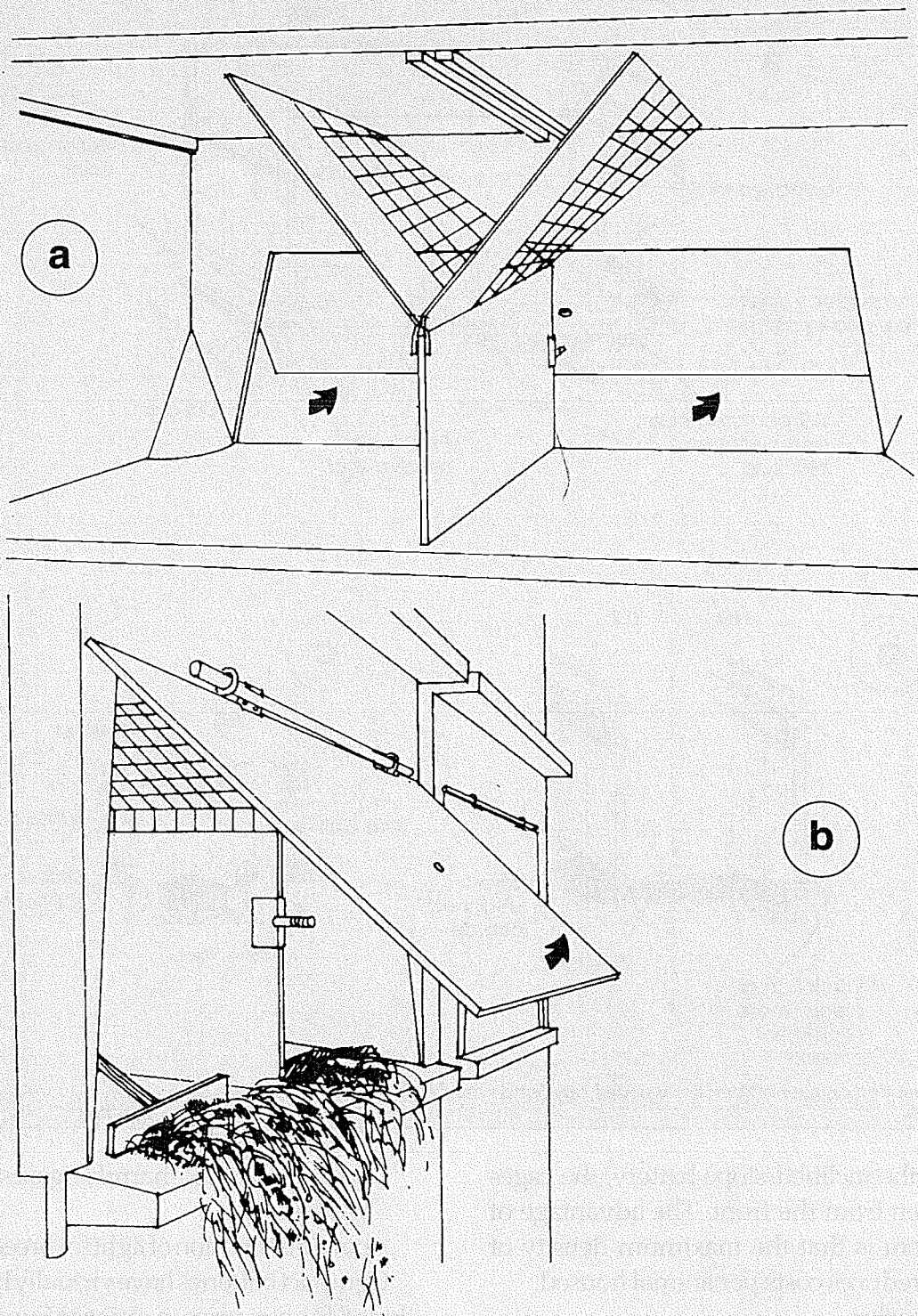
*Swinging rear wall in concrete hutch for waste removal*

Note: a = front view (note forage rack, here shared by two cages); b = rear view.  
Source: Thébault, Rougeot and Bonnet, 1981.



FIGURE 28  
Four systems for using wire cages

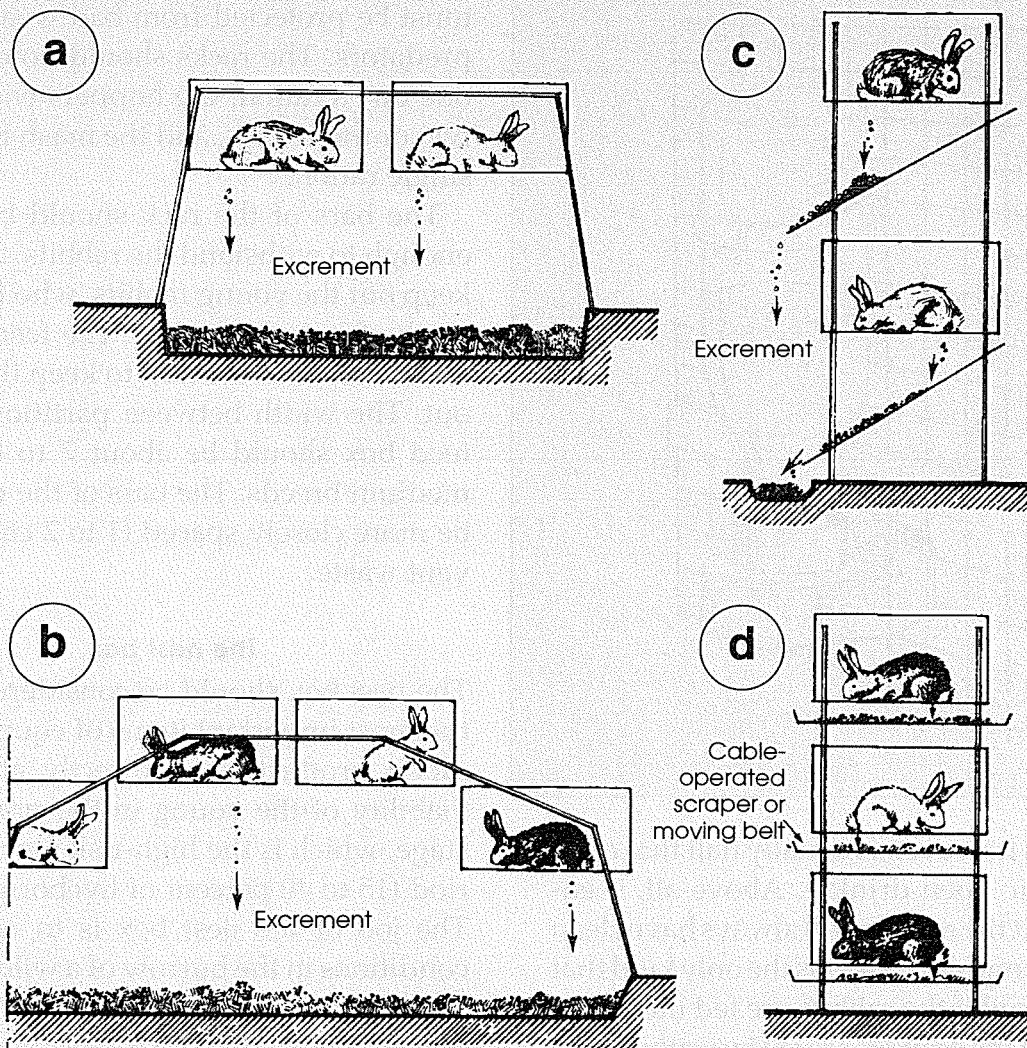

Note: a = flat-deck; b = Californian; c = inclined-slope battery; d = compact battery.

are not fed green forage alone. Using old cans or glass or earthenware pots as drinkers can create a hygiene problem. Rabbits tend to soil their water, especially if they are reared on straw litter. The drinkers should be fastened so that the rabbits cannot overturn them and so that the breeder can easily clean and refill them once or twice a day.

One possible improvement is an inverted water-bottle drinker. A bottle is inverted over a small trough (Figure 29), which is small enough to restrict pollution. The bottle

is big so that it needs to be refilled less often and the breeder can see at a glance whether the animals' water intake is normal.

The best solution is an automatic drinker in every cage (Figure 30). The open drinker guarantees that the rabbits will be watered but it is expensive and there is a high risk of water pollution. A nipple drinker requires some learning on the part of the rabbits and wastes water. Even if there is no leak, the rabbits do not drink all the water that drips out. This can then wet litter or waste.

FIGURE 29  
Inverted water-bottle drinker

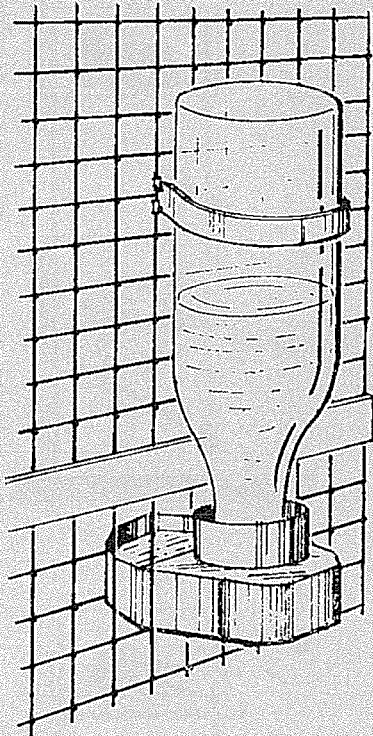

The cost, however, is usually half that of an automatic open drinker. Above all, it ensures that the rabbits will always have clean water. A nipple drinker is the only kind that can be used if the rabbits are fed meal.

Automatic drinkers are fed by water from a low-pressure tank 50 to 150 cm above cage level. This tank can be used to administer medicine with the water. It is usually filled either by water under pressure (automatic watering) or manually (semi-automatic watering). The tank must be in the shade so that the water will not heat, which would be bad for the rabbits. Further solutions are seen in Figure 31.

#### Feed troughs and racks

Cages should be fitted with troughs (feed hoppers for grain or pellets, small troughs for feed mashes) or forage racks, or both, depending on how the rabbits are to be fed. Troughs must be easy to clean and disinfect, so they should be detachable.

Figure 32 shows a hopper for grain or pelleted feed. Troughs and racks should be easy to fill from outside the cage without having to open the access door, but the feed must be protected from bad weather and predators. The racks should hold at least one day's ration, the hoppers enough for two or three days, and the mash troughs a single ration.

The bars of the rack should be strong enough to withstand the rabbits' teeth and keep out the young rabbits, who like to lie on the forage but soil it. The feed hopper should also have a trap to keep the young out. The width between partitions in the feed box should be about 7 to 8 cm for medium breeds. The bars of the racks can be more closely spaced (1 to 2 cm) to prevent waste.

#### The nest box

The nest box should be considered one of the most important items of equipment in rabbit production. It directly affects the viability of the young in the preweaning stage, which is the high-risk mortality period (15 to 40 percent of liveborn rabbits). The job of the nest box is to reproduce conditions in the burrow of a wild doe and protect the young against attacks from the outside environment so that they can get through the first few difficult days of life in optimal comfort. To do this the nest box must:

- allow the doe to kindle and nurse her young in comfort;
- keep the young in a healthy, clean environment;
- prevent dampness from the animals' urine;
- keep the young together in cold weather and help them maintain a constant temperature close to 30° to 35°C in the middle of the nest;
- in hot weather, allow the doe to scatter the nest so that the young can adapt to the temperature;

FIGURE 30  
Automatic drinkers

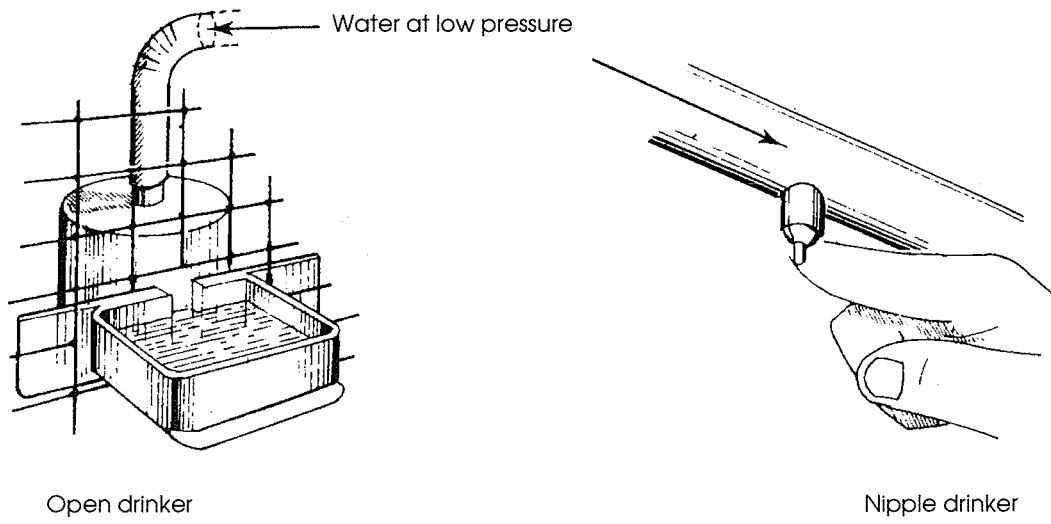
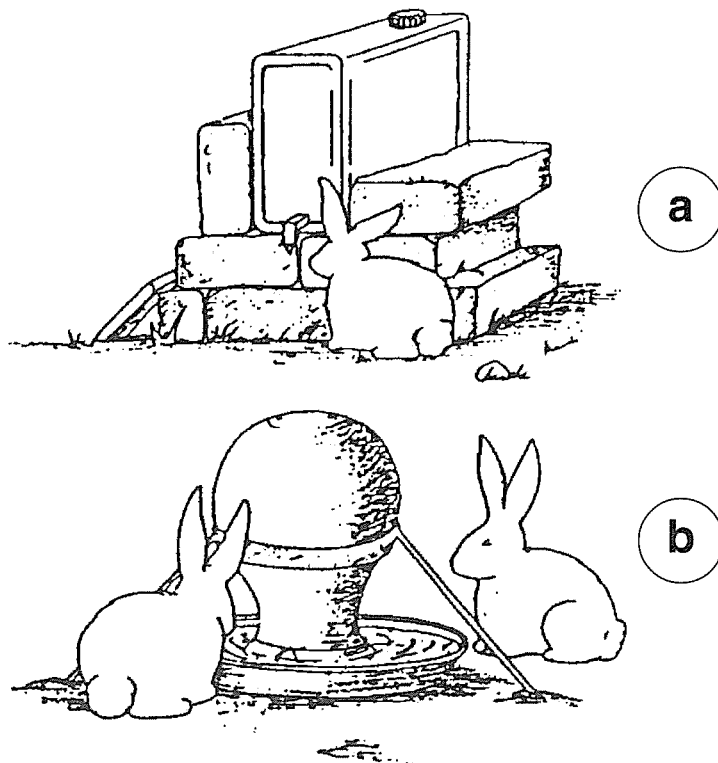
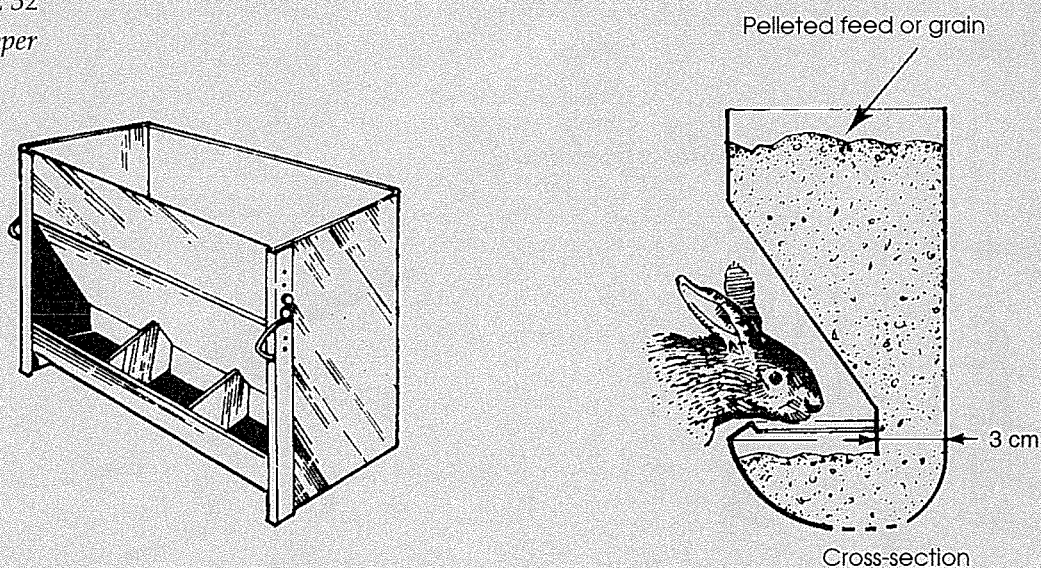

FIGURE 31  
Drinker made from a nipple in plastic bottle (a) and clay drinker used as inverted water bottle (b)



Source: Finzi and Amici, 1992.

FIGURE 32  
Feed hopper



- keep the young from leaving the nest too early and make it easy for them to get back if they do get out;
- allow the producer to monitor the litter, remove any dead animals, introduce baby rabbits to be fostered and change bedding material easily, without disturbing the doe and the young.

The nest box is strongly advised for rabbitries using straw litter; it is essential in modern production. The box most recommended to meet these requirements, especially the doe's comfort when kindling and nursing, is a rectangular paralleled pipe at least 50 x 25 x 25 cm. If there is a dividing panel to keep the young together, at least 30 x 30 cm must be left on that side so that the mother can nurse them in comfort (Figure 33).

The nest box should be made from materials that are impossible to gnaw, easy to disinfect, insulating and resistant to moisture. In a well-heated rabbitry or a warm climate, galvanized iron can be used if some other material such as plywood, wood or plastic is used for the bottom. Untreated wood, fibreboard, plywood or plastic are frequently used in Europe. They insulate better than metals, but except for plastic are not always easy to disinfect.

To comply with the habits of the doe and her young, and to make the breeder's work easier, the box should have the following features:

- the bottom should be hollowed so that the young can huddle together when the temperature drops, but it should also favour their dispersion when the temperature rises;
- the bottom should be non-skid, to prevent dislocation of the young bones ("swimming");
- access for the doe should be opposite the section holding the young so that she will not crush them when entering the nest box suddenly;
- the access hole for the dam should be fairly narrow, square or round, and about 15 cm across;
- the bottom of the box should be designed to allow urine to run off. It can be perforated or a space 1 to 1.5 cm wide can be left between the floor and the sides of the box. Another alternative is straw sandwiched between two layers of mesh;
- the bottom should be detachable so that the whole interior of the box can be cleaned;

FIGURE 33

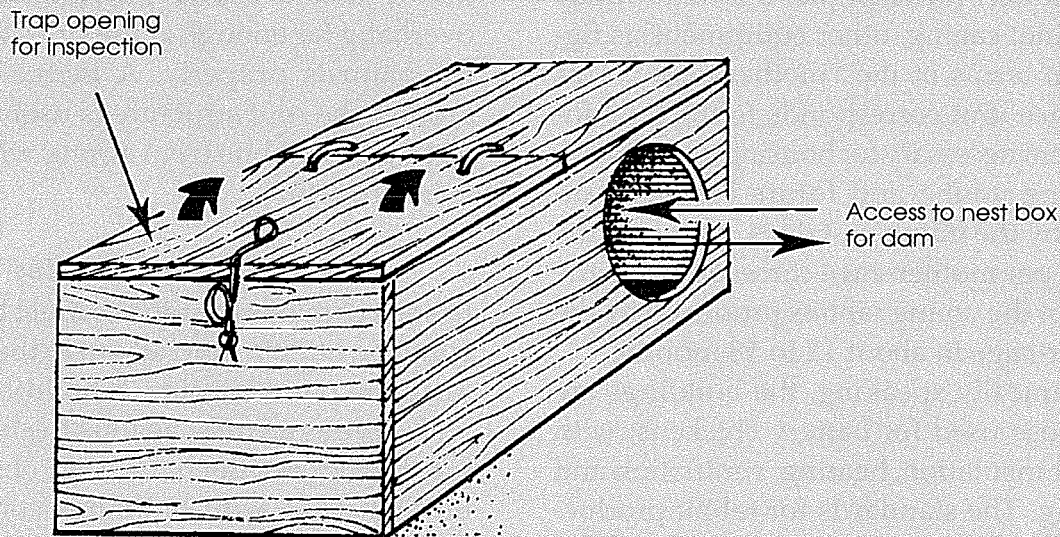
*Design for a nest box*

**Note:** In hot climates the top of the box can be made of wire mesh.

- the top should have a trapdoor so that the breeder can easily observe and check the rabbits;
- there should be a sufficiently high ledge, level with the doe's access hole, to keep the young from leaving the box too early (before day 15). An even better solution is to install the box below the level of the cage floors so that the babies can get back easily.

The doe needs materials in addition to her own fur to make a good nest. Clean straw or soft, untreated wood chips are suitable and dried grasses can be used. Cellulose cottonwool must never be used.

The nest box can be placed inside or outside the cage. If it is outside it can be fastened to the side of the cage or preferably to the front, to make inspection easier.

### BUILDINGS

#### In temperate climates

In countries with temperate or cool climates, rabbits are reared in buildings that are more or less closed in order to ensure year-round production. Traditional rabbit production

in Europe and North America used to be outdoors in hutches and the animals stopped breeding from the end of summer until early spring. More regular or even nonstop production has been made possible by putting the cages indoors.

Temperature and lighting can be controlled to suit the animals. Now the use of wire-mesh cages makes the rabbits more susceptible to the temperature and air flow in their environment and these cannot be controlled fully except inside a building. Even so, if the rabbits are reared in semi-open, fairly unprotected environments, as is increasingly the case for fattening rabbits in Europe, the temperature and ventilation standards in Table 50 are no longer applicable. Animals raised outside are more tolerant of weather variations than indoor rabbits.

In Europe, breeding rabbits are usually reared in floor-level wire-mesh cages, and European rabbits are thus increasingly reared inside closed buildings, with controlled ventilation, artificial lighting, winter heating and possibly summer cooling.

Such solutions are costly and the producer needs substantial initial capital to house all his or her animals.

In France, for example, the total outlay (building, caging, other equipment) is figured in terms of the "mother-cage". This reference unit corresponds to the total investment necessary for housing does, bucks, fattening young and future breeders, divided by the number of does. In France the outlay per mother-cage corresponds to the value of the young rabbits produced by the mother-cage in about 12 to 18 months.

Technically speaking, the buildings are like those used for battery chickens, with similar insulation, heating, ventilation and lighting. The standards for rabbit production, described at the beginning of this chapter, are, of course, different, but for the rest the rabbit breeder can make convenient use of descriptions of buildings designed for chickens. The many instances of old stables, barns and similar buildings being converted for rabbitries is worth mentioning. Some work is usually needed: sometimes insulation, nearly always ventilation, even for flat-deck systems. Unlike compact batteries, the flat-deck system does not need a very long building, and can therefore usually be installed in any existing construction.

#### **In constant hot climates**

In countries where the climate is hot but fairly constant (mean minima and maxima between 20° and 30°C) closed buildings are not really necessary. All that is needed is to protect the rabbits against the weather. If the cages are of wood or concrete (solid walls) it may be enough to roof each hutch, as shown in Figure 34. A roof should keep off rain and also heat from direct sunlight. The hutches can also be placed under trees big enough to shade them all day long. A roof should overhang enough to keep water out on rainy, windy days. The hutches should face away from the prevailing winds.

Wire-mesh cages can be grouped under a common insulating roof. This system, illustrated in Figure 35, was first tried in California. It is satisfactory provided the roofs overhang far enough at the sides to protect the animals properly. A hedge or fence around the roof structure is useful in protecting the rabbits from strong winds, and from predators.

#### **In variable hot climates**

In such climates the rabbits must be reared either on litter in hutches out in the open, or in cages placed inside a building which will serve as a buffer against the heat. Very satisfactory results have been obtained in Burkina Faso with buildings constructed with local palmyra (*Borassus aethiopicum*), and a straw roof. The temperature in a building like this is more constant than in a more costly one made with concrete perpend.

At the Irapuato National Rabbit Centre in Mexico, solid buildings are generally left open in the front during the day and at night the shutters are closed to offset the drop in outside temperature. A daily temperature range of 20°C is common in the region. These shutters also make it possible to ventilate the interior during the daytime; they can be opened to suit the wind direction and regulated to respect the air-flow standards mentioned at the start of this chapter.

In some dry tropical regions of Africa where wood is scarce, producers have made satisfactory housing by building small round huts of unbaked earth bricks covered with straw, used for both cage and housing. Litter changing is often quite a problem with this sort of construction, however. The floor should slope slightly and be off the ground. Parasitism can be partially controlled by demolishing the hut every year and rebuilding it a few metres away. Such housing is thus only suitable for backyard rabbitries in which labour is not a problem.

FIGURE 34  
*Outdoor wooden cage*

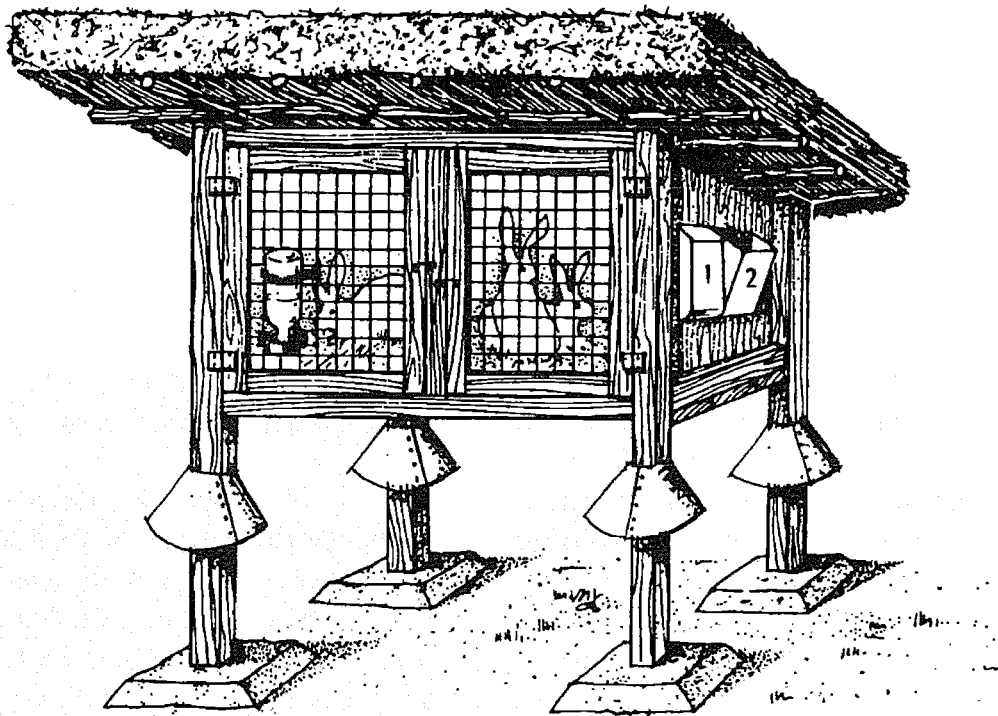

Note: Observe insulated roof to protect the rabbits from the heat, feed hopper (1) and forage rack (2) on the side of the hutch.

FIGURE 35  
*Wire-mesh cages under a common roof*

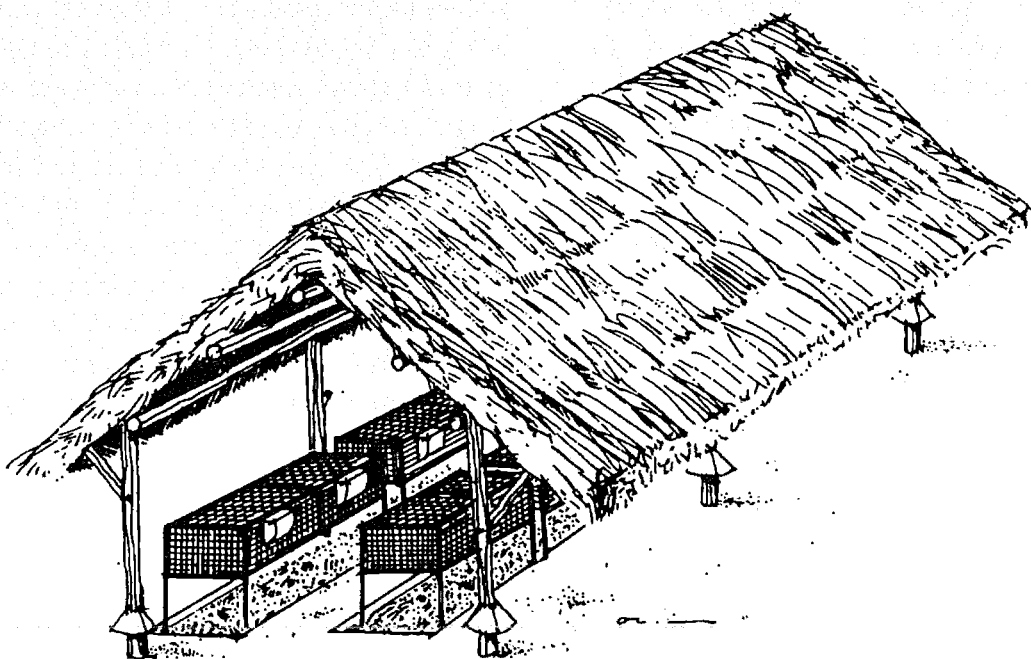

### Predators

The problem of predators differs greatly from region to region. The first step is to build cages sturdy enough to withstand the rabbits themselves and the numerous dogs and cats found in many villages. The rabbitry should be fenced to keep out children and large predators such as dogs. This also helps provide the quiet surroundings that rabbits require. According to needs, the building or complex of cages making up the rabbitry should be fenced with wire netting, a living thorn hedge or sturdy pickets.

Rats, mice and other rodents are also dangerous predators as they attack the young and carry diseases. Any rats in the rabbitry should first be exterminated, then the legs of the cages and the poles holding up the roof can be fitted with tin plates or cones at a height that will prevent rats from climbing them. Wire-mesh or concrete cages are more effective in keeping out rats than are wooden ones.

These pests can sometimes get into the feed racks or hoppers. Where such a risk exists the openings of these accessories have to be protected too, because a mother rabbit does not usually guard her young as a dog or even a mother rat would do. Snake control, in countries where this is a problem, is a far more difficult matter. Breeders get used to paying a certain toll to snakes. Fortunately, this is a small percentage of the rabbits.

Apart from the danger of predators, the risk of escape must also be considered. If the cages and buildings are not properly closed the rabbits can get out: either during handling operations or if the rabbitry is attacked by dogs or other large animals. A well-made outer fence usually ensures that the escaped rabbits can be recaptured quickly. If they do get away, they may well be irretrievably lost.

There is no risk that escaped domestic rabbits will adapt to living wild and multiply, as they did in Australia and New Zealand. In almost every other country,

escaped domestic rabbits have been unable to adapt to the wild. There are numerous predators of animals the size of rabbits (dog and cat families, birds of prey), which soon destroy them. The only risk is on certain islands where potential predators do not already exist, as was the case in Australia in the last century.

### UNCONVENTIONAL HOUSING

The usual techniques for cages and buildings known to give reliable results in all climates have been described so far. This does not rule out other practical solutions, some examples of which are given below.

#### Underground rabbitries

In the southern parts of Tunisia and Algeria, breeders traditionally rear rabbits in a dry "well" 1.5 to 2 m deep (Finzi, Tani and Scappini, 1988). Breeders first dig the well and then lower the rabbits who will breed a colony, building burrows at the bottom of the well. These are used by does as nests, reflecting wild rabbit burrows. The breeder simply throws down fodder, which can occasion significant waste. In more elaborate rabbitries, the breeder digs a sloping tunnel from the bottom up to ground level where it emerges into a small pen. The feed is set in the pen and the rabbits come for it at will (usually at night). A trapdoor in a corner of the pen allows the rabbits to be caught. Of course this system can only work in countries where it hardly ever rains and the ground remains dry down to 1.5 to 2 m. Another drawback is uncontrolled breeding and the breeder may easily maintain totally unproductive rabbits for long periods. Predator control is virtually impossible as well, particularly for rats.

Finzi (1992) describes another underground pen for group rearing, the result of field observations and experiments, shown in Figure 36. Note the simple predator control and rabbit shelter concepts.



### Cage rearing

A system of cages using broad cement channels (0.8 to 1 m wide) laid horizontally has been described in Spain by Contera (1991). The rabbits live on a wire-mesh floor slightly narrower than the channels, and the droppings fall into the channel. The cage/shelters are conventionally equipped. In the hottest hours of summer, systematically sprinkling the outer walls of the channels cools the temperature compared with the outside, the water evaporating through the fairly porous cement of the channels.

Another heatproof device was described by De Lazzer and Finzi (1992): a system of dual-zone cages. Outside is the conventional wire-mesh cage with the feed racks

and inside an "area" of equal volume buried beneath a layer of thick earth but accessible to the breeder through a trap, with the two connected by a 20 cm fibrocement tube (Figure 37). These authors have reconstituted a living area for the fattening or nursery rabbit(s) in the cage that resembles the living space of wild rabbits. During the hot hours of the day, or when there is a disturbance (or to kindle), the rabbits stay underground. When hungry or thirsty, they move into the wire-mesh cage. Experience has shown that the animals always use the outside as a latrine area. The technical results obtained by these authors in one year indicate a productivity wholly comparable with conventional closed rearing in cages, but at

FIGURE 36

*Rational enclosure for rabbitries*

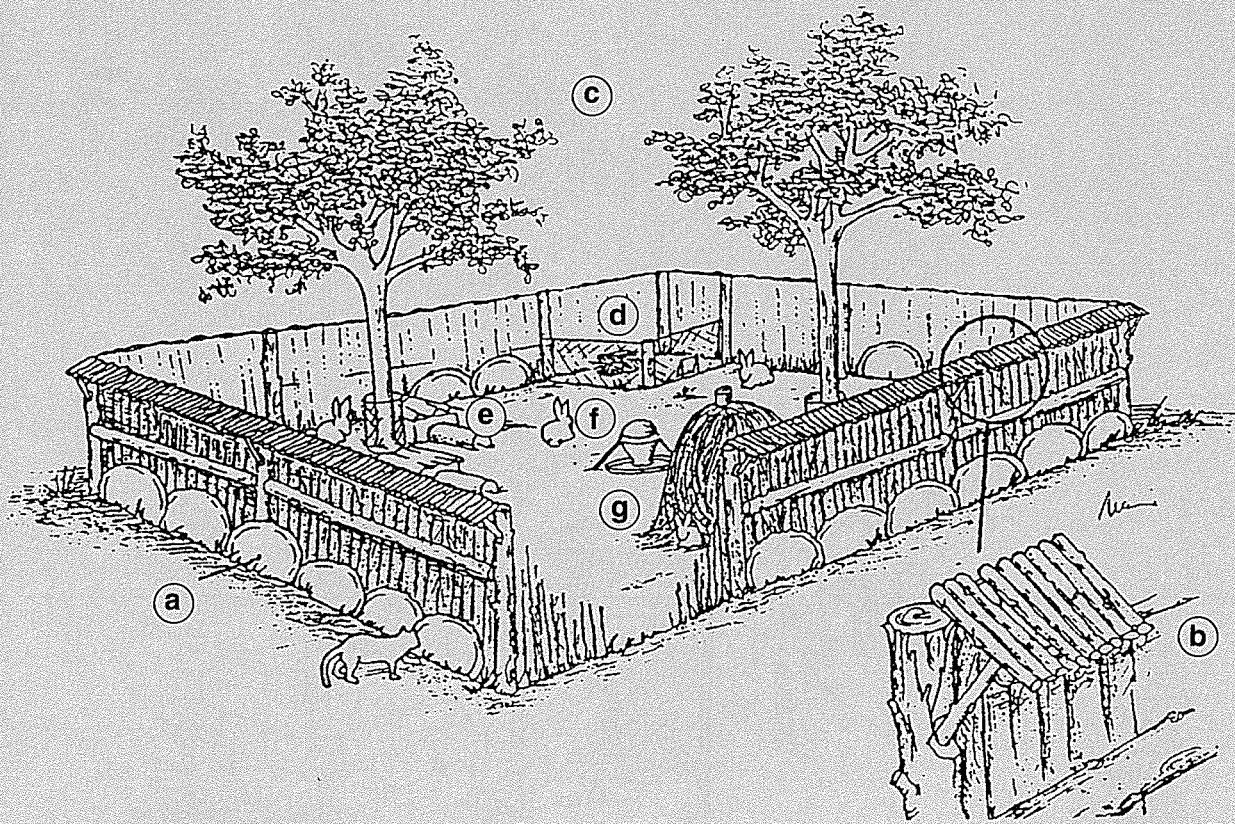

Note: a = tops of drums to protect the foot of the palisade; b = top of the palisade built to keep predators out of pen; c = trees to provide shade and perhaps fodder leaves; d = rabbit catching area; e = nest box accessible to breeder; f = feed rack; g = haystack used as shelter.

lower cost. No information is available on the labour required to build the system.

#### USES FOR WASTE

In every type of rabbit production unit the producer has to remove the excrement and waste from the rabbitry (straw litter and droppings which pile up under cages). These can be put to good use on the farm. The amounts and composition of waste vary according to housing and feeding conditions.

Rabbits eating balanced concentrate feeds and raised on mesh floors produce about 25 to 400 g of faeces and 0.5 to 0.8 litre of urine per mother-cage a day, depending on production intensity. This waste is much richer in nutrients than ordinary farm manure (Table 54).

In fact, farm manure contains only 0.4 to 0.6 percent of each of the main fertilizer components: N,  $P_2O_5$  and  $K_2O$ .

The composition of the waste varies with the type of rabbit (Table 55). A comparison of the figures in Tables 54 and 55 shows a greater risk for nitrogen and phosphorus losses during storage than for other elements.

The average composition of the manure of rabbits reared on litter depends partly on the kind of feed but mostly on the kind and amount of litter used. If well preserved, the waste collected weekly will contain the nutrients in the faeces, part of those in the urine and those in the litter. Fertilizer "production" is therefore at least equal to that in a rabbitry not using litter.

FIGURE 37

Two-zone cage: wire-mesh (at left) and underground (at right). The breeder has access through the corrugated top laid over the underground area

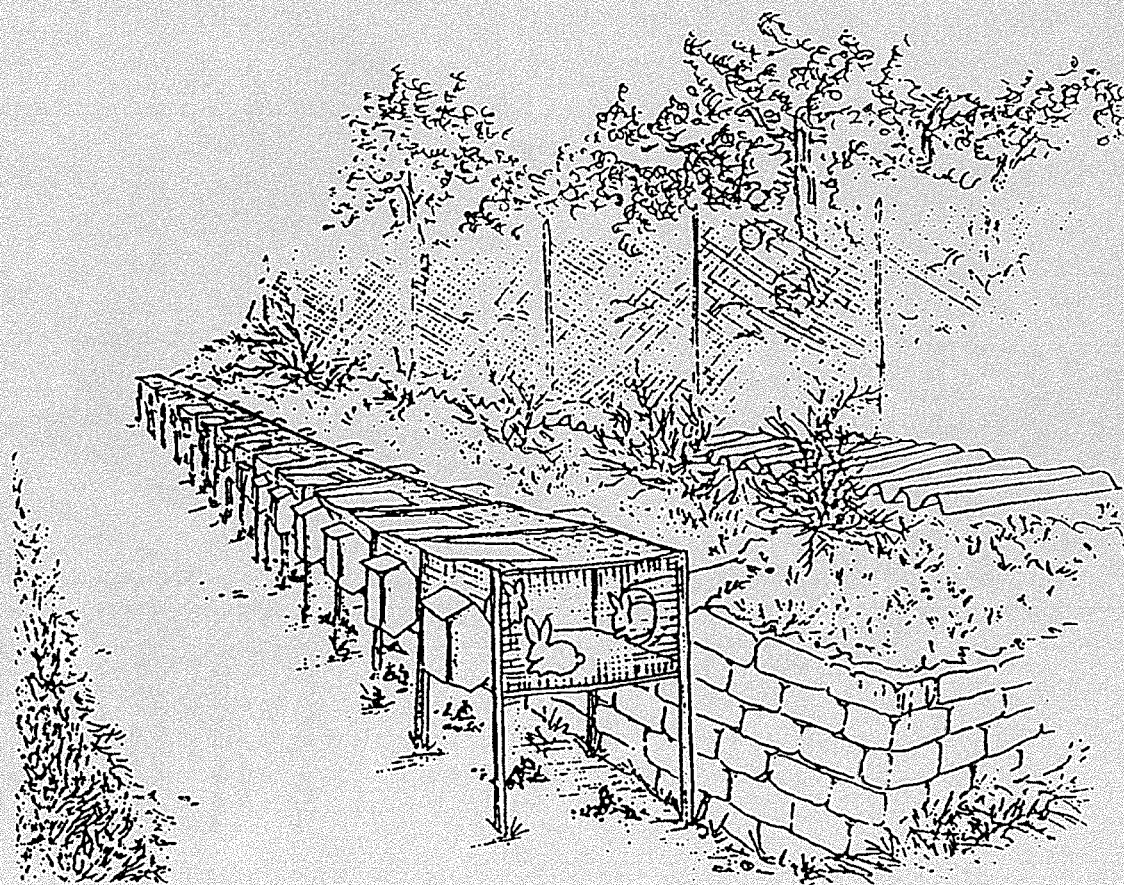

Source: De Lazzer and Finzi, 1992.

TABLE 54  
Average composition of excrement collected under wire-mesh cages of rabbits receiving balanced concentrates (percentage)

Breakdown of crude product	From Varenne, Rivé and Veigneau, 1963	From Franchet, 1979
Dry matter	40-50	24-28
Total minerals	14-18	5-11
Nitrogen	0.8-2.0	0.7-1.0
P <sub>2</sub> O <sub>5</sub>	1-3.7	0.9-1.8
K <sub>2</sub> O	0.2-1.3	0.5-1.0
CaO	0.9-3.4	0.4-2.0
pH	7.2-9.7	8.1-8.8

Source: Varenne, Rivé and Veigneau, 1963; Franchet, 1979.

TABLE 55  
Quantities and composition of excrement produced by different categories of rabbit

Origin	Weight produced per day (g)	Content of fresh product (%)			
		N	P <sub>2</sub> O <sub>5</sub>	K <sub>2</sub> O	CaO
<b>Faeces</b>					
Fattening young	40-50	1.5-1.7	2.5	0.5	0.4-1.5
Nursing doe	150-200	1.2-1.5	5-7	1-1.5	2-3
Resting adult	70-80	1.2-1.5	2-4	0.5	0.4-1.5
<b>Urine</b>					
Fattening young	80-110	1-1.3	0.05	0.8-1.2	0.4-0.6
Nursing doe	250-300	1-1.3	0.02	0.7-0.8	0.15
Resting adult	100	1-1.3	0.08	0.9-1.2	0.6-0.7

Source: Lebas, 1977.



## Chapter 7

# Rabbitry management

Questions of management are discussed in various parts of this book. This chapter brings these different aspects together. The technical and economic criteria presented apply primarily to rational rabbitries of a certain size (at least 50 does). The rules of technical management are the same for smaller units, but the economic variables are different. The objective of small-scale units is not to make the greatest possible profit, but to achieve satisfactory productivity with a low-input system using local resources and family labour.

### THE PRODUCTION CYCLE

As ovulation in does is induced by mating and the females are generally kept in different cages from the males, it is the breeder who determines the reproduction rate of the unit. These rates vary from one or two litters a year under the most extensive management to eight to ten litters in an intensive management system. In rational European rabbitries does are remated either immediately after kindling (intensive system) or about ten days later (semi-intensive). European backyard rabbitries use a more extensive system, presenting the doe to the buck one or two months after kindling. Young does are first presented for mating at four to seven months, depending on the breed (lighter breeds are usually more precocious) and, especially, on the diet.

In the semi-intensive system illustrated in Figure 38, the does are first presented to the buck at four and a half months. They are then mated 10 to 12 days after the birth of each litter. Weaning takes place at 30 to 35, or even 37 to 38 days. Many European breeders (France, Italy, Spain) used to prac-

tise the intensive system: mating does within 48 hours of kindling and weaning the young at 26 to 28 days. This, however, requires very good feeding and a producer with a fairly high level of expertise and was gradually abandoned during the 1980s.

Extensive systems are characterized by a long delay between kindling and mating, and perhaps even until weaning. For example, the young may be weaned at 56 days and the doe mated after weaning. This system is still practised in France in farm rabbitries, where breeding does are fed fodder and grain.

At weaning the young are separated from the doe. The duration of fattening varies, depending on the carcass weight required and the growth rate possible in the feeding and production conditions of the rabbitry.

In intensive European production, where weaning takes place at one month, the fattening period is seven weeks. The rabbits weigh 2.3 to 2.4 kg (live weight) when they are ready for the market. Some African breeding units where weaning takes place at two months are reported to need a four-month fattening period, because balanced feeds are not available. European and North American countries which market rabbits at live weights of 1.7 to 1.8 kg use a different system. The young are not weaned. They are left with their doe up to the age of two months, when they are sold. The mother is remated three weeks before that. This system can produce five or six litters a year. In Spain, however, at a highly comparable sales weight of 1.8 to 2 kg live weight, rabbits are weaned at about one month, then fattened for only one month more. These breeders are actually using the

FIGURE 38  
Production cycle of the domestic rabbit

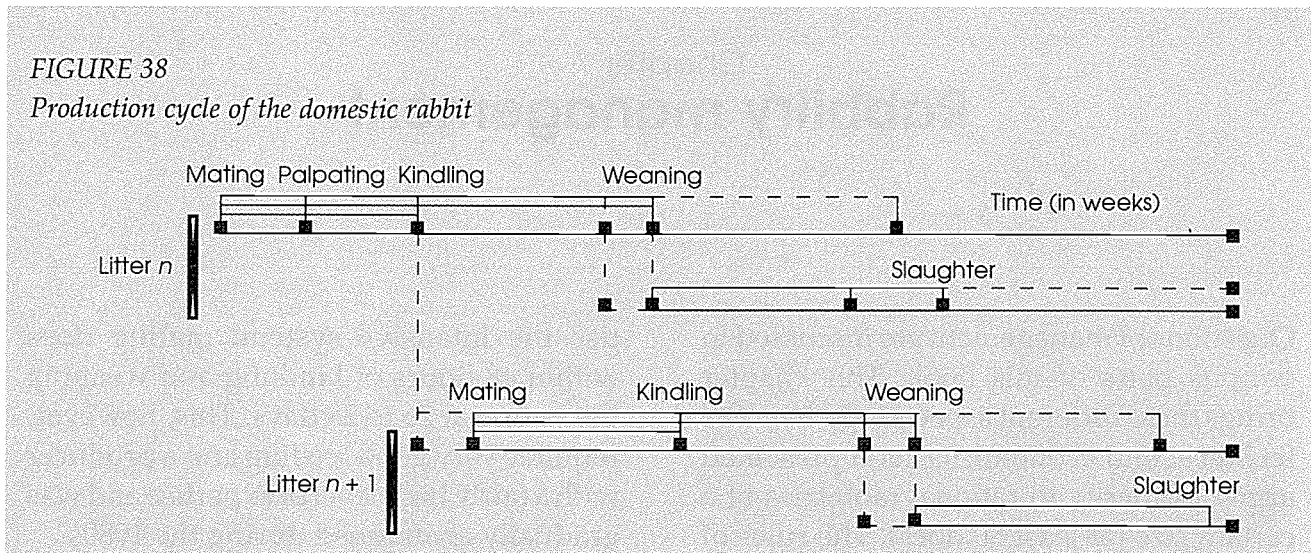

semi-intensive reproduction rate to obtain a great many kindlings and hence more rabbits per doe each year.

### Reproduction

**Mating.** Servicing is always done in the buck's cage. The breeder checks the doe's health at this time to make sure she has no respiratory disorder, sore hocks, etc., or that she is not too thin. A red vulva is a promising but not infallible sign (80 to 90 percent chance of mating success). A buck can fertilize a doe with a white vulva, but the success rate is only 10 to 20 percent. When the doe has accepted mounting and the buck has serviced her the breeder removes the doe and puts her back in her own cage. Altogether this should not take more than five minutes.

While the doe is being handled the producer can carry out any treatment necessary – anti-mange, for example. If the doe refuses to mate, the breeder can try to present her to another buck, as a last resort leaving her for 24 hours in the buck's cage but then cannot be sure that mating has taken place. It is better to mate the animals in the morning or evening, to avoid the hottest hours of the day. Some breeders in France practise double mating. This means that the doe is mated twice in succession at intervals of 10 to 15 minutes, either by the

same male or by two different males. A similar technique is to leave the female in the male's cage for 15 to 20 minutes after mating has first taken place. These techniques allow a slight increase in the percentage of pregnant does (4 to 6 percent, roughly). The drawback, however, is that it considerably increases the number of matings per male and in this system no male can be mated to more than two females each week without jeopardizing the outcome through over exploitation of the buck.

In intensive breeding one buck can serve seven or eight does. In the extensive system one buck can serve 10 to 15 does. The buck, however, should not be used more than three or four days a week, and not more than two or three times a day, which means no more than six ejaculations per week. So even if there are only, say, ten does in the unit, there should be at least two bucks so that successful mating is not dependent on one buck alone. When the size of the unit permits (at least 50 does), one or two reserve bucks are kept. If a balanced pelleted feed is used the bucks should be fed from 120 to 180 g per day, depending on their weight.

The first mating of medium-size, properly fed does takes place around four months. Bucks are first mated at about five months. If production conditions are not optimum the first mating will be delayed

until the animals reach 80 percent of their adult weight. There is no advantage in delaying it further. The breeders should carefully supervise the first mating. For the first month the young buck should not be mated as often as an adult.

**Determining pregnancy.** The only effective way of determining pregnancy is to detect the embryos in the doe's uterus by palpating the abdomen. This operation should be carried out between 10 and 14 days after mating. It is not effective if performed earlier (before the ninth day), while after the 14th day the operation is more delicate and there is a risk of provoking abortion. The breeder must palpate the doe gently and expertly in order not to cause an abortion.

If palpation shows the doe to be empty she is presented to the buck again as soon as possible, if the breeder mates the animals every day in the week. But if the breeder practises group rearing or cycling (paced by the week), he or she will represent the doe to the buck (or use artificial insemination) two to three weeks after the non-productive mating. If the rabbits are merely raised as a group, however, with all does in the production unit at the exact same stage of reproduction (in this case only artificial insemination is used), an empty doe will simply be marked for the appropriate feeding (and perhaps housing) for her situation. She will be reinseminated only with the other does in the production unit. Presentation of the doe to the buck as a test of pregnancy is pointless, though not dangerous. Indeed, a large proportion of pregnant does accept mating and some empty does refuse. Nor is doe live weight an indication of pregnancy, because weight fluctuations depend on too many factors.

Preparations for kindling (supervision, nest box, changing bedding material, etc.) should be made for all the mated does from the 27th to the 28th day after mating if they

have not been palpated, but where palpation has been practised regularly the preparations are restricted to does found to be pregnant.

A pregnant doe that is not nursing a litter will be rationed if the breeder uses pelleted feed. The daily ration for medium-size does will be about 150 g (35 to 40 g/kg live weight). If the doe is nursing a litter at the same time she will be fed ad lib.

**Kindling.** Kindling should take place in quiet, hygienic surroundings. The breeder's presence is not required, but the nests should be checked as soon as possible after kindling. This operation is easy and there is no risk to the young. It can be performed right after kindling, provided the mother is removed. The breeder should remove any dead animals and any foetal sacs the doe has not eaten.

A nursing doe needs considerable nutrition and from the time of parturition she should be fed ad lib. Drinking-water is very important in the days leading up to and following parturition. The doe will nurse her young once a day, usually in the early morning.

The mortality rate between birth and weaning is still high (15 to 20 percent today in European rabbitries). A mortality figure of less than 10 percent is very difficult to achieve. Therefore the nests have to be inspected daily and any dead animals removed. Strict preventive hygiene is more important than ever at this period.

**Fostering.** The breeder may decide it is necessary to eliminate excess newborn rabbits in a large litter, or they may be fostered to a smaller litter, if certain rules are respected:

- no more than three or four young rabbits should be given to a foster mother;
- the maximum age difference between the foster doe's litter and the fostered young should be 48 hours;

- fostering should take place within three days of kindling.

Where a production unit is big enough, and particularly where the breeder practises group rearing, systematic fostering is recommended to achieve equal litter size. The ideal size for withdrawal/fostering is average litter size at kindling (or somewhat smaller if there is a feeding problem). Where there are too many young rabbits the chances of survival are poor and, if young rabbits are to be culled, the lighter ones should be chosen.

**Weaning.** During the weaning period the young gradually give up milk for solid feed. Weaning is also the time when the breeder separates the young from the doe. The breeder may opt for one of the two following weaning methods: all rabbits in the litter are withdrawn at the same time and placed six to eight per cage in the area set aside for fattening. Alternatively, the doe may be removed from the cage and the young rabbits left, a method which reduces postweaning stress for the young rabbits but does necessitate the right production equipment. Management must be geared to group rearing. If the young rabbits are moved (still the more common system), the cages must be very clean and the litters should be kept together, if possible, for uniformity. The alternative is same-age cages (maximum age difference one week) with all rabbits put in the cage the same day. Rabbits soon establish a social hierarchy in the cage and any new introduction is a source of conflict. During the transfer operation the breeder checks the health of the young rabbits, culling any that are undersized or sick.

Weaning can take place when the rabbit's live weight tops 500 g (after approximately 26 to 30 days in rational European production). The young rabbits begin to eat solid feed at 18 to 20 days and at 30 days the doe's milk provides no more than 20 per-

cent of the daily dry-matter intake. Practically speaking, young rabbits benefit from late weaning until the age of six weeks. Depending on the rate of reproduction chosen, weaning should take place no later than two or three days before the doe's next kindling: e.g. 28 days for postpartum fecundation to 38 to 39 days for fecundation taking place 11 days after kindling (42-day rate).

**Stock reduction and renewal of breeding does.** One of the apparent drawbacks of intensive reproduction is the rapid turnover of breeding stock. Monthly culling rates of 8 to 10 percent are not uncommon. In fact, where reproduction is intensive the breeder soon learns the value of each doe and can thus keep the best. The total number of rabbits produced by each doe during her working life is fairly independent of the rate of reproduction imposed by the breeder. Whatever the reproduction and the monthly stock renewal rates, to avoid having empty cages in the nursery there should be a constant reserve of does available that are ready for mating.

The breeder has several means of renewing breeding does. The most practical solution, applicable to both pure breeds and "ordinary" strains, is to select the best young from the best does. To avoid inbreeding, the bucks and even the does should be obtained from another breeder (selector). If production is intensive, the producer can buy breeding animals from a selection programme of specialized strains for cross-breeding – the system of stock renewal to follow will be advised by the supplier.

Renewal mainly takes the following two forms:

- The introduction of male or female breeding animals for direct replacement of does or bucks which have been culled or died. These are called "parental renewal stock" (the direct parents of rabbits intended for sale).



- The introduction of grandparents. Here, the parental rabbits are born within the breeding establishment, the progeny of bucks and does of special complementary lines which live and produce in the same establishment and have a reserved place in it. These grandparent rabbits are in turn replaced by rabbits direct from the selection centre, but in much smaller numbers than needed for the direct renewal of parental animals.

Whatever the genetic type of rabbits brought into the establishment for the renewal of breeding stock, they should be brought in at a fairly early age. INRA's research shows the best solution to be day-old rabbits. This method, proposed in 1987, was soon adopted by French breeders. The future breeding rabbits are immediately fostered by does with good maternal aptitude in the establishment. The young rabbits adapt much better than those introduced at the age of eight to 11 weeks, and particularly four months or older. The rabbits nurse only once in 24 hours, leaving an entire day for their transfer from the selection centre to the rabbitry. This has even been extended to 36 hours to allow the day-long and problem-free transfer of rabbits from the west coast of the United States to France.

#### **Fattening and slaughter**

During the weaning-to-slaughter growth period the rabbit should always be fed *ad lib*. If the breeder uses balanced concentrates, the average daily consumption will be 100 to 130 g for medium-size animals. In good conditions the rabbits will gain 30 to 40 g a day, which means an intake of 3 to 3.5 kg feed will produce a 1 kg gain in live weight. Young fattening rabbits can also be fed cereals and fodder, with or without the supplement of a suitable concentrate.

During this period mortality should be very low – only a fraction of the fattening stock – but it is often far higher. Preventive

hygiene (cleaning, disinfecting) is essential in the fattening station, but the breeder is often inclined to pay less attention to this area than to the nursery.

The animals are sold alive or as carcasses. Rabbits raised in rational production systems are sold at about 70 to 90 days at weights of 2.3 to 2.5 kg for strains such as the New Zealand White and Californian. In extensive production systems with less well-balanced feeding the rabbits may be sold much later (four to six months, maximum). Fattening animals that have passed the usual age for sale can form a reserve from which the breeder can draw for home consumption or stock renewal. In farm rabbitries, the mortality risk from accidents, epidemics and so forth is still high and any delay in the regular slaughtering age for whatever reason, such as keeping the rabbits alive for gradual home consumption, can end in disaster, with the death of all the animals. The higher the mortality rate during fattening, the more the breeder will tend to shorten the length of this production phase.

If rabbits are to be kept beyond three months the bucks must either be put in individual cages or castrated, so that they can continue to be colony reared. The females may remain in groups, but will need more cage space than they did before three months. Castration is a simple operation, though it usually requires two people (see brief description in Figure 39).

Breeders may wish to slaughter their own animals. The necessary installations are relatively expensive if the proper standards of hygiene and conservation (cold storage, etc.) are to be respected. Staff who will work only a few hours per week are also needed.

#### **HANDLING RABBITS**

Rabbits should be handled gently. They should be lifted by their ears as little as possible. Several techniques can be used to pick them up and hold them.

FIGURE 39  
Castration of young male rabbit

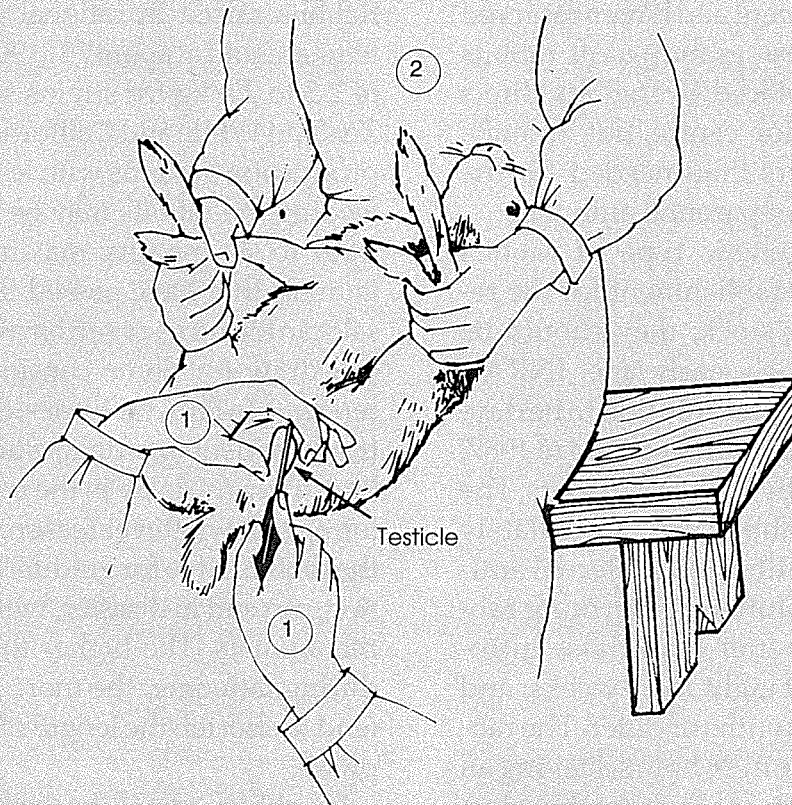

The rabbit is held on its back on the lap of an assistant (2) who holds both legs on the same side in each hand. The operator (1) presses the rabbit's belly from front to back to make the testicle appear. Using a razor, he makes a deep incision, cutting the skin of the pouch and also the testicle. At this moment, by a reflex movement, the testicle comes out. It now remains only to cut the "threads" fixing it to the abdomen. Next disinfect with iodine. There is no need to stitch the wound as it heals in five or six days. Bleeding to any extent is very rare. However, for rabbits of four months and over it is best to crush the threads rather than cut them. There are castrating pincers which crush the threads, eliminating the need for an incision. Source: Lissot, 1974.

A rabbit can always be picked up by the skin of the back (Figure 40). For animals weighing under one kilogram, one method is to pick them up and carry them by the saddle just above the hindquarters, using thumb and index finger (Figure 41). If the animals are heavier it is best to take them by the skin of the back, but if they have to be transported or shifted for more than five or ten seconds they must either be supported with the other hand (Figure 42) or be carried on the forearm with the head in the bend of the elbow (Figure 43).

If an animal struggles and the producer feels he cannot control it, it is best just to drop it so it will fall on all fours and then pick it up again correctly within two or three seconds. If the breeder keeps his hold on a struggling rabbit he risks some nasty scratches and can even break the rabbit's backbone.

#### ORGANIZING AND MANAGING A RABBITRY

##### First operation: identification

Identification can be made in two ways: by individuals and by cages. The first method

FIGURE 40

Correct way to pick up a rabbit



FIGURE 41

Holding a young rabbit head down

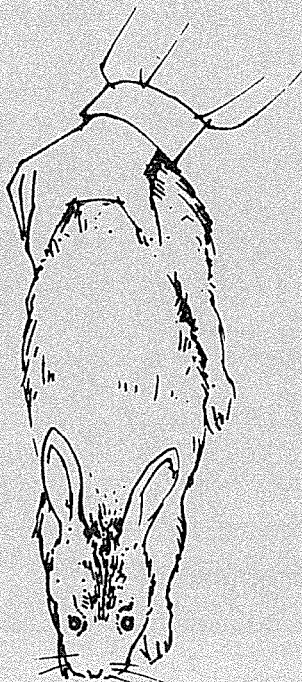

The animal is grasped by the back at the haunches.

is necessary for all producers who intend to select. The second is important for the economic management of the rabbitry.

**Individual identification.** Each animal is assigned a number. This number will appear on all documents concerning the rabbit and on the rabbit itself. There are three main ways of identifying rabbits on a lasting basis; not all are equally good:

- rings: a numbered ring is attached to the hind leg just above the hock. Risk of losing the ring is high;
- clips: numbered clips are attached to the rabbit's ears. These clips are made of metal or plastic and risk of loss is again high;
- tattooing: small holes are punched in the rabbit's ear spelling out numbers or letters and these are filled by rubbing in a special ink. A well-made tattoo lasts throughout the rabbit's lifetime. Although this method takes longer, it is the only one that is really sure. It can be done at weaning using special rabbit pincers, or on adult rabbits with sheep pincers (Figure 44).

**Cage identification.** The management unit of a rabbitry is the mother-cage. All the cages in the nursery section should be numbered and this is the figure that will appear on the records. This method is much easier than individual identification so it is used in rabbitries which keep records but do not breed for selection purposes.

An identification system is essential even in small rabbitries. It will form the basis of the technical records that will serve for both the organization of the work and the economic management of the rabbitry.

#### Technical records and organization of work

**In the nursery.** This unit will occupy most of the producer's attention. A daily record book is essential in almost every kind of production. In large European production

FIGURE 42  
Carrying a large rabbit, supporting its hindquarters

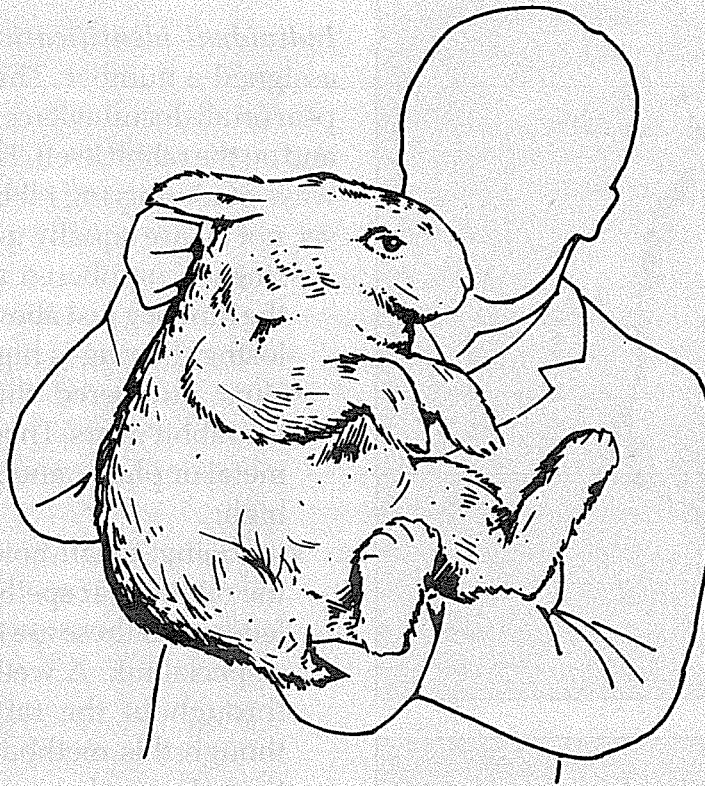
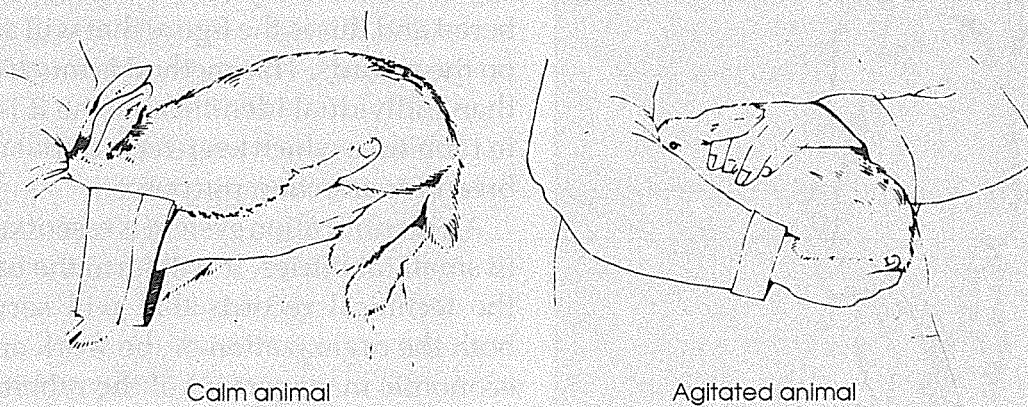

FIGURE 43  
Technique of carrying a rabbit on the forearm



Calm animal

Agitated animal

FIGURE 44

Using a clipper with movable numbers to tattoo the identification number on a rabbit's ear

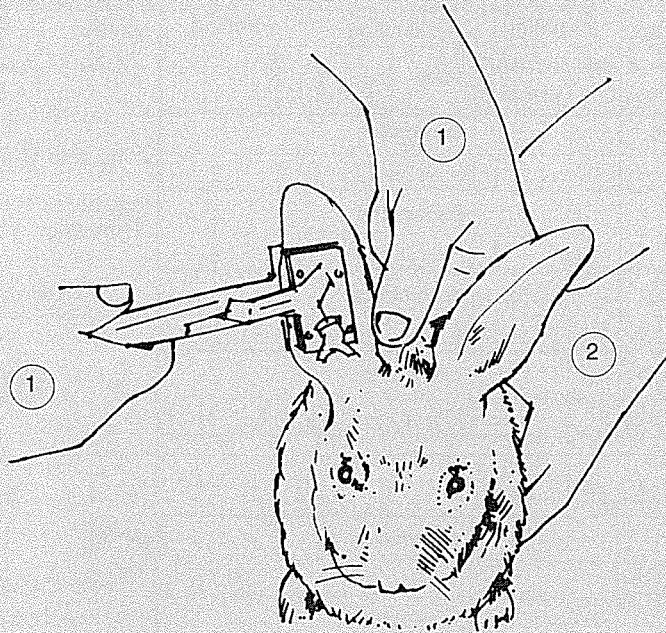

Note: 1 = operator's hands, 2 = assistant's hand.

units, most of this information is now computerized. The producer notes the chief operations simply and clearly:

- mating days for each doe, indicating sire (used to check buck fertility);
- outcome of palpation, where performed;
- numerical size of each litter at birth;
- numerical size of each litter at weaning.

The young does selected for replacement are identified at weaning.

This list is far from complete. Litter weight at weaning could be added, for instance. If the producer uses balanced feeds the amounts fed in the nursery will be entered to compute the average feeding cost per weaned rabbit. This is an important item in calculating net profit. A similar entry would be equally helpful for other types of feeding, but these are far more difficult to estimate.



The record book system is often inadequate. One improvement is a doe card

hooked to each cage, for calculating individual doe productivity. The example shown in Figure 45 summarizes the items of information just listed. Another useful addition is a buck card (Figure 46).

The next step is to put the data together to get an overview of the unit for efficient organization of the work. This is essential in any rabbitry with more than a few dozen does.

Planning pigeonholes (Figure 47) offer a virtually foolproof way of monitoring all events in the nursery. Assuming that does are remated and litters are weaned no later than one month after kindling, the system involves a large box with four horizontal rows of 31 compartments. Each corresponds to a day of the month. The first row is for matings, the second for pregnancy checks (palpation), the third for births and the last for weanings. If weaning takes place between one and two months, which is common in extensive production, there will be

FIGURE 45  
Example of a doe card

1 <sup>st</sup> mating		2 <sup>nd</sup> mating		3 <sup>rd</sup> mating		kindling			weaning		breed	origin	
date	number ♂ palpation	date	number ♂ palpation	date	number ♂ palpation	date	live	dead	number		(5,5)	1 (0,1) 0,2,9	
	217		217			comments						2	
82	050-	82	064+			095	10	001	9	9	entry date [82] 0,2,5		
	217					comments						age at 1 <sup>st</sup> mating	1,2,0
82	106+					137	11	302	7	6	DOE CARD		
	withdrawn		854		354	comments							
82	155	82	162-	82	176+	207	07	00	03	7	7		
	854		854			comments							
82	211-	82	225+			256	04	03	04	1	0		CAGE No
	854		854		854	comments						1,0,6,4,2	
82	260-	82	274-	82	288-	comments						cause: empty	
comments						culled?							

two rows for weaning, for even months and odd months.

Every morning the producer sees in the work book what operations are to be carried out. As each is completed, the card of the doe concerned is moved into the pigeonhole corresponding to the next operation and the day for which it is scheduled.

In a rabbitry where mating takes place ten days after kindling and rabbits are weaned at 35 days, the doe record could be as follows: suppose the doe is mated on the third day of an odd month. Her card is then placed in the palpation row. This operation is performed on the 16th of the same month (+13 days). If the result is positive, the doe card is placed in the kindling row under the second day of the following month (+15 days). If it is negative, her card will go back to the mating row. After kindling the doe card returns to the mating row under the 12th day of the same month (+10 days). At

the same time, a card with the doe's individual and cage numbers will be placed in the weaning row, in space 7 of the second, odd month (+35 days).

There are other planning systems. The important thing is to use one system consistently. Computerized individual performance records can combine these parameters and list the daily operations to follow in line with the management model adopted by each breeder, listing the history of each breeding animal.

Scheduling several matings, a few palpations and the weaning of several litters all for the same day adds up to a lot of wasted time. Using a weekly work plan one person working eight hours a day can manage 250 to 300 does. Table 56 is an example of such a work plan. Scheduled matings (Thursdays and especially Fridays) mean other activities can be grouped (weaning on Tuesdays, palpation on Wednesdays).

FIGURE 46  
Example of a buck card

Date M	No. ♀	P	NL	Date M	No. ♀	P	NL	Date M	No. ♀	P	NL	
												No. of male
												_____
												No. of cage
												_____
												Breed
												_____
												Date of birth
												_____
												Weight at 1st mating
												_____
												Age at 1st mating
												_____
NOTES:												

Note: M = mating, P = outcome of palpation, NL = number of rabbits born live.

Some activities such as nest supervision and feeding have to be carried out every day.

With this method batches of litters at weaning are close to the same age. It also sets the time for activities the producer always tends to postpone, such as recording data and carrying out preventive hygiene measures.

This weekly management plan, used for nearly 30 years, has expanded into age-group rearing or cycling as described above. At first all rabbits of the same age were grouped in the same part of the rabbitry (hence the term age group). Next, breeders kept same-age rabbits only in the same rearing unit. Each unit was cleaned and disinfected after the rabbits were sold or put in a newly cleaned unit. This means breeding does move regularly from one unit to another at each weaning (hence the term cycling).

Age-group rearing quickly led to rabbit production units organized into just three age groups at intervals of two weeks or two age groups at intervals of three weeks, with a semi-intensive "42-day" rate of reproduction in both instances, and fecundation by natural mating or artificial insemination. In the last two or three years, some Italian and French breeders have been working with a single age group: all does in the establishment are fecundated on the same day by artificial insemination only once every 42 days.

These different management techniques have basically evolved to reduce the amount of labour per rabbit, even though productivity per female is not as high as is theoretically possible.

**Fattening records.** Here again the daily record book is essential. It will list the first and last fattening days (sale or slaughter) of the animals in each cage, any mortality

FIGURE 47

Diagram of planning pigeonholes

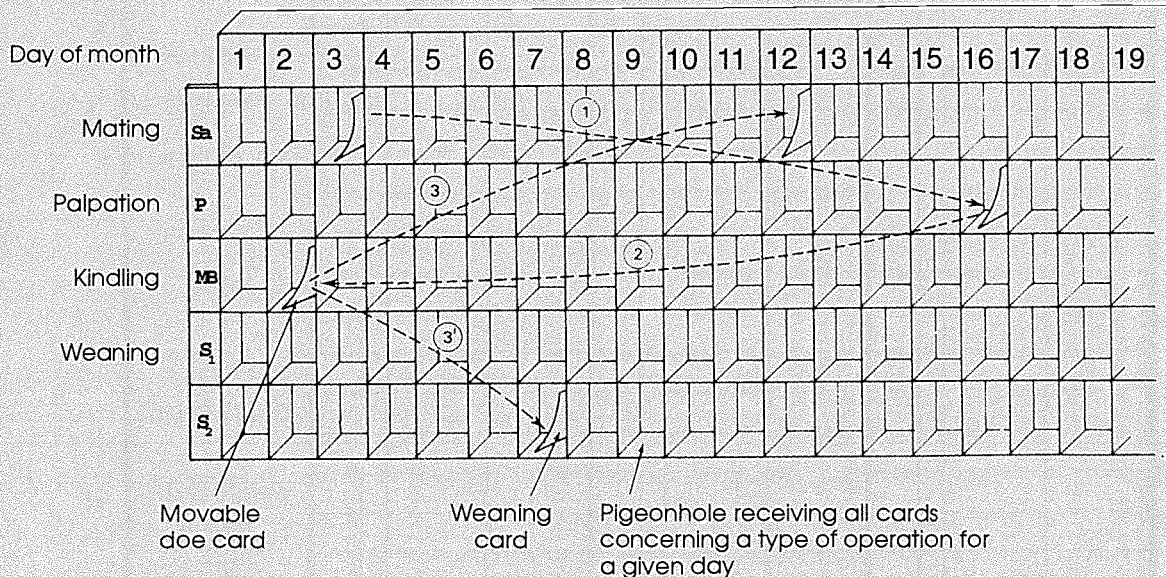

Note: See text for explanation of card movement.

and the apparent causes. Live weight when sold and the number of animals marketed weekly could also be added. In large-scale operations, production checks will be done by batches (a batch is a group of rabbits weaned the same week). The batch will be the core reference point of all technical data.

If the breeder uses balanced concentrates he or she will record the amount of feed eaten by fattening rabbits. Feed conversion efficiency (the amount of feed needed to produce a weight gain of 1 kg) is a sound economic criterion. If the producer wants to breed stock for selection purposes a litter card is used listing the weaning weight and date, the weight and date at sale or slaughter and the individual identification number of each rabbit.

**Working hours.** In a rational production structure under European production con-

ditions, some 12 to 20 working hours per week per 100 does that are actually producing is the rule. Same-age rearing in a well-organized establishment can even reduce this to under ten hours. Indicatively, listed below are average working times per week in 1991 in a group of 18 rabbitries in south-eastern France, each for 100 producing does and their progeny (GELRA, 1991).

• Mating + palpation	2 h 28 min
• Checking nests + fostering + weaning	2 h 40 min
• Feeding	2 h 20 min
• Cleaning	4 h
• Monitoring + treatments	1 h 40 min
• Clean-out	40 min
• Sales	50 min
• Management	40 min
• Other	35 min
Weekly total	16 hours



TABLE 56  
Example of weekly work plan

	Monday	Tuesday	Wednesday	Thursday	Friday	Saturday	Sunday
Numbering kindlings and first check	x	x					
Weaning young and initial selection of future breeding animals		x					
Culling sick and unproductive females	x				x		
Filling in doe cards	x						
Second selection of future breeding animals at 70 days		x					
Cleaning equipment and building		x		x			
Health inspection of animals and nest boxes			x		x		
Palpating does mated two weeks earlier			x				
Mating of females that kindled the previous week and does empty when palpated				x	xx		
Setting up nest boxes					x		
Filling in buck cards					x		
Routine activities (supervision, feeding)	xx	xx	xx	xx	xx	xx	x

Note: X = operation to be performed on day marked.

### SOME PRODUCTION TARGETS

Table 57 shows the performance records since 1983 of selected French rabbitries monitored under technico/economic management. It covers more than 1 100 production units for the last year. The parameters change little from one year to the next.

The main productivity criterion is the number of progeny per breeding doe per year. The average here is 46 young rabbits for the year 1992. Strikingly, the range of performance around this mean is great: in the 275 most productive units (the top quarter), the

output was 58.7 young rabbits sold per doe. The yearly renewal rate of does of 131 percent means that in order to maintain 100 breeding females year-round, 131 new does must be introduced each year, i.e. the average productive life of a doe is just over nine months ( $365 \text{ days} \div 1.31 = 279 \text{ days}$ ) between the first mating and withdrawal (culled or dead).

Basically, the average production per doe depends on the theoretical breeding rate set by the breeder (in France the doe is presented to the male eight to ten days after kindling), the ratio of kindlings to mating (73.3 percent

TABLE 57  
Annual production performance in France from 1983 to 1992 in rabbitries monitored under technico-economic management

	1983	1985	1987	1989	1991	1992
Number of rabbitries	404	488	661	543	922	1 101
Number of does per production unit	148	174	196	216	241	256
Percentage of annual renewal	141	157	155	144	135	131
Kindlings/mating	68	69	70	72	72	73
Kindlings per doe per year	7.4	7.4	7.5	7.4	7.2	7.2
Total newborn in litter	8.3	8.6	8.6	8.7	9.0	9.1
Birth-weaning mortality,	21.3	24.3	22.0	19.4	19.4	19.1
of which stillborn	7.4	7.0	6.4	5.9	5.5	5.5
Mortality at weaning/sale	14.9	12.4	12.5	13.7	12.7	12.9
Number weaned per doe per year	48.4	48.0	50.1	52.2	52.1	52.9
Number sold per doe per year	41.1	42.1	43.8	45.0	45.5	46.0
Average live weight at sale (kg)	2.33	2.34	2.30	2.34	2.34	2.36
kg of feed/kg of sale weight	4.37	4.22	4.18	4.13	3.97	3.95

Source: Koehl, 1993.

in 1992), litter size at birth, and the survival rate of newborn rabbits.

A further 25 percent of these rabbits are lost before sale. Technically, the range is also great here, with the best breeders selling a little over 90 percent of their liveborn rabbits.

Economically, the consumption index is a major item. Under French conditions, feed accounts for over 50 percent of all production costs, including labour. In 1991 for the first time, breeders spent a little over 4 kg feed to produce 1 kg of rabbit for sale, including the feed consumed by rabbits sold, breeding does, bucks and replacement breeding animals. In different economic conditions the portion of feed cost price may vary, but it is always the major expense item.

Various external agencies (research or development agencies, private firms) may collect weekly data on production performance and evaluate the parameters for the

purpose of helping breeders collect and analyse these technical criteria, keeping the breeder abreast of performance at all times. Computer programs can provide the same information at the production-unit level, but regular comparisons with other rabbitries will highlight weak points for the breeder.

#### Economic management

As with keeping technical records, not all producers have the same needs in economic management, which mainly concerns those whose purpose is to make the maximum profit.

There is a great deal of variation in this area. Results depend on the expertise of the breeder and his or her economic situation, so there is not much point in giving absolute figures.

Table 58 shows the relative importance of the various cost items for a group of 18 French breeders followed in 1991. Figures are given in percentage of turnover.

TABLE 58  
**Cost schedules in French production units as a percentage of annual turnover: averages and values for the upper and lower thirds of rabbitries classified by doe productivity**

	Lower third	Average	Upper third
Number of progeny per doe per year	37.0	45.5	54.3
Feed	56.4	52.0	49.8
Energy + water	4.0	3.7	3.7
Health	3.3	3.9	3.0
Breeding animals	2.1	2.8	2.7
<b>Total operational costs</b>	<b>65.8</b>	<b>62.4</b>	<b>59.2</b>
Write-off and financial costs	9.6	8.0	5.9
Social costs	2.4	2.2	1.8
Insurance and miscellaneous	3.2	4.9	4.1
<b>Total structural charges</b>	<b>15.2</b>	<b>15.1</b>	<b>11.8</b>
Labour (= net margin)	19.1	22.5	29.0

Sources: GELRA, 1992; Koehl, 1992.

TABLE 59  
**Influence of various factors on income of a French production unit**

Factor	Variation		Improvement
	Absolute	Relative (%)	Relative income increase (%)
Fertility (%)	+5	+ 6.8	+14.6
Number born per litter	+1	+11.1	+35.7
Birth-weaning mortality (%)	- 5	- 25.8	+17.6
Mortality during fattening (%)	- 5	- 39.4	+17.6
Feed consumption per rabbit sold	- 1 kg	- 10.8	+12.6
Feed purchase price (FF/100 kg)	- 10 FF	- 6.2	+12.9
Rabbit sale price (FF/kg live weight)	+ 1 FF	+ 7.4	+32.4

**Note:** These results reflect French conditions. The various factors are interlinked and cannot, therefore, be added. Figures are indicative.

Sources: GELRA, 1992; Koehl, 1992.

To indicate variability, figures are also given for the six least-productive rabbitries (37 progeny per doe per year) and the six most productive rabbitries (over 54 progeny per doe per year). A major expense item, as stated, is feed purchases. Depend-

ing on productivity, the share of turnover used to pay wages ranges from 19 to 29 percent, even though the rabbitries in the study lie in the same French region and are thus economically comparable in terms of feed purchase price and rabbit sale price.

As always, the higher the level of investment the greater the unit productivity needed to write off these debts. Productivity should be expressed either as unit of investment or as working time, depending on which is the main local constraint.

Table 59 looks at the influence of various production factors on income. The findings are indicative and valid in French conditions for production levels close to those in Table 57.

Among the financial factors, sensitivity to sale prices for rabbit meat is very high. In these circumstances it is easy to see the advantage of direct sales.

Improvement in overall production has a substantial impact on producer income. Careful selection of genetic type will increase profits by increasing litter size under specific breeding conditions.

## Chapter 8

## Production of rabbit skins and hair for textiles

Meat is definitely the main goal of rabbit production. Two by-products are usually also recovered from the skin: the pelt and the shorn hair, with no particular production constraint.

Angora rabbits, however, are produced solely for the hair. The only way the producer can be sure of quality hair is to apply a very specific methodology quite different from that used in meat-rabbit production.

The same can be said for the production of quality pelts from special strains such as the Rex. The appropriate techniques, intended primarily to obtain a good pelt, make meat a by-product of the skin. Bearing in mind the special vocabulary used in the fur industry, this chapter includes a small glossary to help the reader with the definition of some specialized terms.

### **RABBIT SKINS: A BY-PRODUCT OF MEAT**

Rabbit fur production is not comparable with the production of other fur species. Mink, which tops the list of species bred essentially for its fur, supplies a world total of about 25 million to 35 million pelts a year whereas rabbit pelts are estimated at one billion. In France alone annual rabbit skin production tops 70 million.

Few skins are now retrieved from slaughterhouses: they are simply thrown away. Those that are used fall into three categories: fur pelts for dressing, pelts for shorn hair (hair removed from skin) and skins for use as fertilizer.

### **Origin of the by-product**

Intensive meat-rabbit production techniques in Europe are usually incompatible with production standards for quality fur pelts.

In fact, the raw skin represents only a small percentage of the value of the living animal. Thus more and more frequently rabbits are slaughtered at an age or time of year when their coats have not fully developed. This is usually at 10 to 12 weeks when they still have an infant coat or are beginning the subadult moult. These thin, unstable coats are not suitable for furs.

The only season when the adult coat is stable and homogeneous is winter. This is true of any animal over six months of age. The rest of the year there are always moult areas of greater or lesser size, so the coat is uneven and the hair is not firmly attached to the skin. Some summer coats can be homogeneous, especially those of rabbits that have completed the subadult moult, but the rabbits must be at least five months old. The summer coat is also thinner than the winter coat.

This rather inflexible growth cycle and seasonal changes in the coat make simultaneous fur and meat production a problem and so fur can only constitute a by-product, especially in intensive production. However, no research has been done on moulting patterns in subtropical countries; the figures given here only really apply to temperate regions.

The only quality skins are from adult rabbits, but the trend in modern rabbit production is to slaughter young, reducing the proportion of adult skins. In extensive production, rabbits are slaughtered at four to six months and this is the situation in many tropical countries. Therefore, quality skins could be produced in the tropics assuming the proper skinning and preserving techniques were used.

### Sorting and grading pelts

**Sorting.** In an unsorted batch of rabbit skins valuable pelts can be found side by side with useless waste, so sorting and grading should be done as early as possible. Sorting, the first operation, determines the future use of the skin. Skins are sorted into three grades:

- *Pelts for dressing* (the term "dressing" instead of "tanning" is used for fur). These are the best skins, with regular shape, intact, homogeneous, dense, a well-formed coat, a flawless skin. Their price may be 20 times that of unsorted quality skins.
- *Pelts for shorn hair.* These usually lack the proper shape or are not homogeneous enough for fur products. The hair, however, is sufficiently long and healthy. It is therefore machine shorn and used for textiles or felting (although the hat trade is declining in many countries). The skin is cut into fine strips (vermicelli) and made into glue (another declining industry) or fertilizer. This technique allows much of the pelt to be recycled.
- *Waste*, unusable except for fertilizer (the hair is gnawed, cut, soiled, sweaty, parasite-ridden). Such skins push up the costs of labour, processing and transport.

In France, one of the foremost rabbit-producing countries, the proportion of pelts suitable for dressing is less than half of those collected. The figure differs from one author to another, which is not surprising in view of the difficulty in getting exact data on this product.

**Classification.** The customer buys the skins in commercial lots (from 0.5 to 5 tonnes) of matching quality.

The following grading system is used in France (and also in many other countries because of the number of French traders in the fur market).

*For pelts for shorn hair.*

- rejects – hair weight 10 to 18 percent of the dry pelt weight;
- ordinary – hair weight more than 18 percent of dry pelt weight;
- good quality, with guard hair removed – for glove-making.

*For fur pelts.* Grading is more complex for fur pelts, as colour, size and quality are all considered. The colours are white, range of grey, range of red (nankin), mixed and black.

Size is assessed by weight per 100 dry pelts:

- entre-deux: 12 to 13 kg/100 pelts (100 to 140 g per pelt);
- cage: 13 to 20 kg/100 pelts (150 to 210 g per pelt);
- heavy: 26 to 40 kg/100 pelts (250 to 350 g per pelt).

The gap between grades and the difference between weight per 100 pelts and unit weight stem from fluctuations in assessment.

Quality assessment covers the integrity of the pelt (proper cut, good fleshing, no knife marks or holes from skinning) and its structure (height of guard hair, compactness and height of downy undercoat and the homogeneity of the coat):

- pelts 4: poorest;
- pelts 3, 2 bis: medium;
- pelts 2 and 1: best.

This classification, which at first sight looks complex, is in fact relatively simple: traders and clients know exactly what merchandise is in question when they speak of a "cage 2 grey" or an "entre-deux 4 nankin".

The system, with slight variations, is the same in every country, understandably so considering rabbit pelts are an international trade item. In the United States, where rabbit production is not widespread and is undertaken by amateurs, United States Department of Agriculture grades are:

- firsts: no defects, thick and regular subhair. Used for furs;

- seconds: some hair defects and a certain lack of thickness, short subhair. For inferior fur and cutting;
- thirds: for cutting (felt) or toys;
- hatters: rejects, the best of which are used for cutting.

Firsts and seconds include five colours: white (price sometimes double that of colours as pelts can be dyed); red; blue; chinchilla; mixed.

Sorting and grading clearly show that it is in the interest of the breeder and the general economy of the country to produce the highest possible proportion of quality pelts or at least reduce the proportion of those which are unusable. It is also important to be able to constitute homogeneous commercial lots. This means that if production is low in a region the range of colours should be limited. The choice is not simple, given the ups and downs of fashion. The wisest choice would normally be white, as it generally commands a good price and once dyed can easily follow colour fashion trends. However, this is not the best advice at present, with long-haired fur in vogue and dyeing virtually in disuse.

White (not Angora) rabbit hair from shorn skins should not be considered a negligible item: it accounts for several thousand tonnes on the world market. France usually exports 100 to 200 tonnes of rabbit hair every year, and imports slightly less. Prices can be quite high: in 1984 to 1985 they held steady at 250 to 300 FF/kg, whereas the usual price is about 100 FF/kg as in 1992.

#### PRODUCTION OF QUALITY FURS

The main barrier to quality pelt production is slaughter age: the pelt must be big enough and the whole coat mature: i.e. a winter coat. The crucial times are moulting – juvenile moults for growing rabbits and seasonal moults for adults.

Quite apart from rabbits slaughtered too young and those raised under poor conditions, the two major defects that make rab-

bit fur a downmarket product are the fragile guard hairs (long coarse hairs in the coat) which break off very easily and the unequal growth of the hair during adult seasonal moulting (zones with shorter or looser hairs).

The Rex rabbit is free of the first defect because the coat contains no guard hairs, an advantage that places Rex furs in a select category of fur classification.

The second defect can be ironed out by production techniques that synchronize moulting in all parts of the body. The combination of this technique with Rex production has made it possible for some rabbit fur to attain formerly unthinkable pinnacles of quality.

#### Moulting

*Seasonal moults in adults.* Seasonal moults in adults, which are ruled by seasonal photoperiodicity, occur in spring and autumn. The spring moults are spectacular, with visible loss of winter hair, but they are slow and irregular and rarely give an entirely stable coat in summer. This summer coat, thin and short, is not among the most prized – it weighs only 50 g. The autumn moult, on the other hand, reactivates all the hair follicles in a relatively short time. It gives longer hairs and above all multiplies the secondary hair follicles which produce part of the undercoat. The winter coat, which remains stable for several months, weighs approximately 80 g. This coat is the most highly prized of all and often the only one used by furriers. In addition, the network of collagen fibres of the derma is contracted and produces a finer and stronger skin.

It is obviously preferable in a temperate climate to slaughter the animal at the onset of winter, as soon as the coat is mature, to ensure the least possible deterioration of the hair. Unfortunately no detailed study has been made in tropical or equatorial climates.

**Juvenile coats.** There are three types of juvenile coat: that of the newborn rabbit, infant coats and subadult coats. The first two are unusable because they are too small. The coat of the newborn rabbit stops growing when the animal reaches 0.4 kg (for an average size breed); it weighs only 8 to 10 g. The infant coat is mature at around nine weeks and its weight depends on the rabbit's weight, since the number of hair follicles in development depends on the size of the skin area of the growing animal. If a rabbit weighs 0.5 kg at nine weeks it carries 15 g of hair, against 30 g for a rabbit weighing 1.1 kg. The coat is thus still light in weight and the hair is fine.

The subadult coat becomes more interesting but the lengthy (four or five weeks) moult which produces it does not start until the rabbit reaches 1.7 to 1.9 kg. It matures, at the earliest, at four to five months (usually five). The weight of the coat, and hence hair length and density, also depends on the season in which the hair develops: 40 g in summer, 60 g in autumn or in winter, which is acceptable given the skin area. The subadult coat is therefore the first coat that could provide a fur.

As a consequence, it is very difficult to obtain pelts for fur in intensive meat-production systems (slaughter at 11 weeks). However, a breeder might attempt to produce acceptable pelts for shorn hair by using simple measures.

It is however quite possible to produce fur pelts under extensive production systems, by not pushing the animals' growth, feeding them a cheap but balanced diet and slaughtering them at the age of five or six months during the winter. It is also possible to produce fur pelts in intensive systems, provided that the rules detailed below are obeyed.

#### Conditions for quality fur production

**Light.** Newborn and subadult moults are not really ruled by seasonal photoperio-

dicity. They can be induced earlier by artificial lighting, but this calls for sophisticated installations (windowless housing) and the technique is complex (two different fattening periods with separate light regimes).

**Temperature** does not govern moults, but if it is too hot the discomfort will make the rabbit eat less, and the coat will suffer accordingly.

**Hygiene.** Any physiological imbalance or pathological disorder has immediate repercussions on the coat, even if it has reached maturity. It becomes dull and unkempt, the secretion of the sebaceous glands is disturbed and the rabbit neglects its grooming. A skin collected in this condition will never make a good fur. Normal hygienic procedures, valid whatever the production system, also favour the production of a quality pelt and help to avoid diseases which specifically affect the skin. This will be one of the most difficult problems for developing countries.

#### Choice of breed and selection

In making this choice there are two factors above all to be considered with relation to grading pelts: colour and size.

Colour is a question of fashion but, as mentioned earlier, white is the most suitable as it is impervious to fashion changes because it can be dyed. It must be remembered that the trader is interested only in lots of four or five tonnes. Large pelts are the most prized; without going so far as to produce giant rabbits this means that midget breeds should be rejected.

Finally, there is the structure of the coat: it should be homogeneous, with long hair and a thick undercoat well covered with silky guard hair.

As has already been mentioned, the Rex breed produces an interesting and original pelt which is softer to the touch but tougher, recalling prestige furs such as chinchilla, moleskin or otter.



## COLLECTION, PRESERVATION AND STORAGE OF PELTS

### Skinning

Skinning should be carried out in a manner that ensures the largest possible skin surface, which is an important part of its value. The first cut is usually an incision at the hind feet, passing from one thigh to the other. The skin is then pulled off. The skin on the head is of no commercial value but it is preferable to keep it because it allows better stretching.

This operation should be done with care to avoid mutilation, knife marks, grease (which oxidizes and burns the skin) or bloodstains. All these defects reduce the value of the pelt, especially when the coat is originally of good quality. The sequence of skinning operations is illustrated in Figure 48.

### Preservation

Rabbit pelts are preserved by drying. This is a simple operation which can be done anywhere and costs little (the salt used to preserve the skins of other species can be expensive). Drying should start immediately after the skin has been removed. It must cool off quickly and dry out to prevent the action of enzymes in the derma which attack the hair root and cause the hair to fall. If fresh pelts are left in a pile for even a short time (more than 15 minutes) a rapid bacterial fermentation will set in and cause the hair to fall out in patches. Many pelts are lost this way through lack of elementary care.

The skins are shaped on a frame. They should not be excessively stretched, nor should there be any creases. The frame can be a board or a steel wire frame (Figure 49). Straw should not be used as padding as it can deform the pelt in places.

During drying, air should circulate freely and the skins should not come into contact with one another. It is unacceptable to accelerate drying by exposing the skins to the

sun or to hot air; above 50°C the collagen of the derma is altered irreversibly and the skin cannot be processed. They should be dried in the shade or in the dark in a well-aired dry place (optimum temperature 18° to 22°C).

Twenty-four hours later it is best to remove fatty deposits on the shoulders and belly to avoid local hotspots.

### Packaging and storage

The pelts are arranged in piles when they are perfectly dry in a cool airy room, with insecticide (naphthaline) between each layer of skin. It is best to grade the pelts without delay, the grading being more or less elaborate according to the size of the stock in question. At least the different qualities should be separated immediately and the white pelts from the coloured.

Whether the destination of the pelt is fur or hair production, all operations from skinning to storage must be carried out with care and attention. The slightest fault in handling results in a lowering of grade, which is all the more serious when a high-quality skin is involved and all the work carried out previously is lost. The greater the homogeneity and quality of the pelts the more attractive they will be to the trader, which is particularly important at times of market depression.

If it is intended to extend rabbit production in a country for the profitable sale of the pelts, training should not be underestimated. Training will be needed not only in production, particularly in teaching producers how to recognize the state of maturity, but also in the care needed in skinning the animal and in preserving and storing the pelt. Experience with hides and skins of other species shows the extent of losses due to negligence (in some countries only one pelt remains from every three animals slaughtered). Perhaps bad habits can more easily be avoided when a new animal-production sector is introduced.

FIGURE 48  
Skinning a rabbit

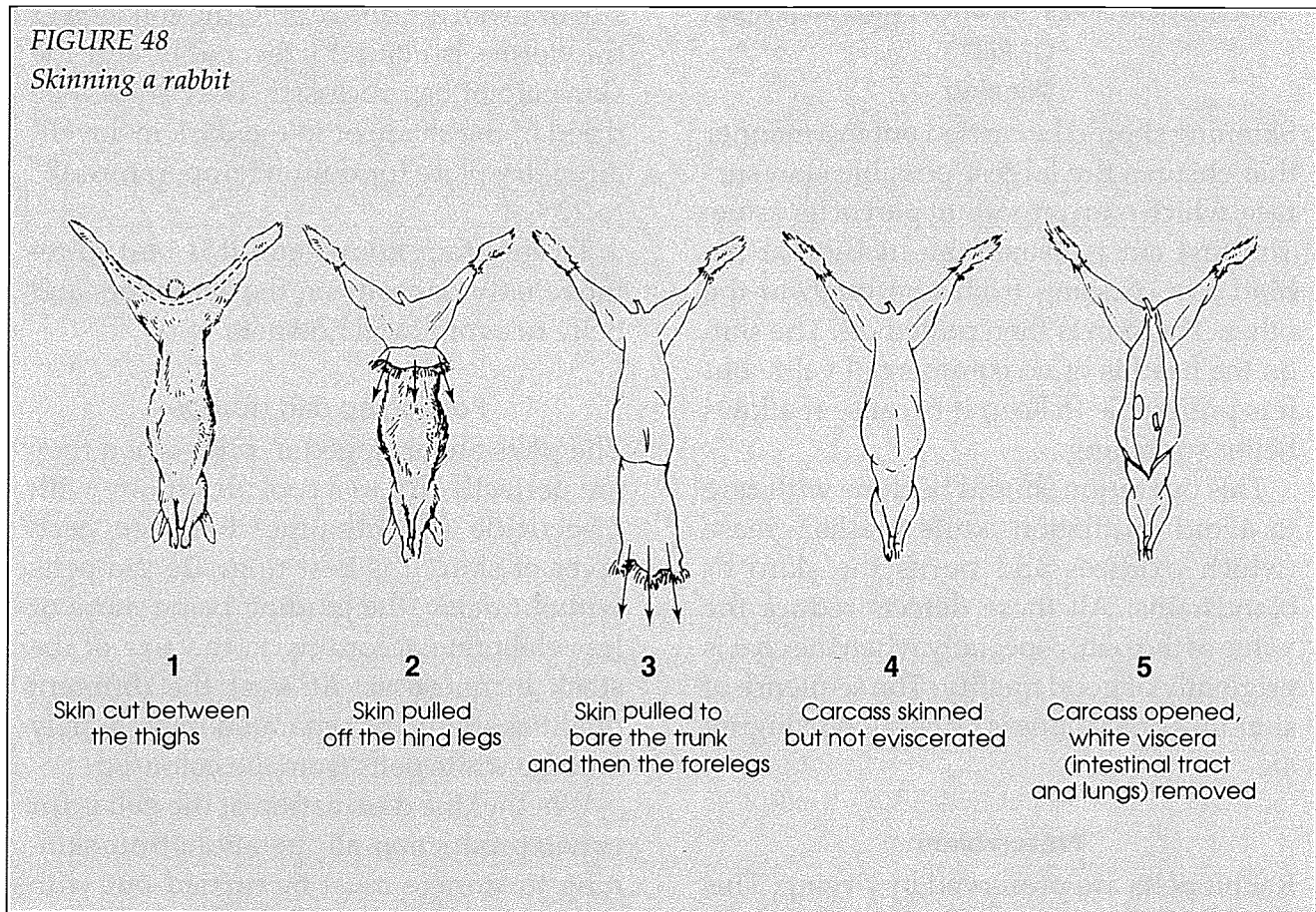

#### CURING AND GLOSSING

Developing countries are increasingly processing the cattle hides and sheep skins they produce. The first step is to turn out semi-finished products, for which the technology is simpler and more uniform, albeit demanding, and for which there is a wider market. Finished leather is a specialized product whose manufacture is far more delicate to undertake as expertise and imagination are both essential.

This is why developing countries are holding back their rough pelts to make semi-finished products such as wet-blues and hides (India, Pakistan). This system obviously has the advantage of using the local labour available, giving greater value to the exported product and facilitating packaging and storage.

Is the same development possible for rabbit pelts? This is difficult enough to answer with regard to other fur, which must always be perfect, and even more difficult for rabbit

fur, towards which there is some consumer prejudice, also because European output, although of medium quality, is so high. On the other hand, shearing the pelt for the hair does not seem to pose any particular problem any more than does making use of the remainder of the skin, even if only for fertilizer. There is also the possible manufacture of small objects such as toys with pieces of low-quality fur; however, this is of relatively small economic importance and may involve difficulties with the hygiene regulations of potential importing countries.

#### Curing

Processing the pelt to the semi-finished stage requires a series of operations:

- dipping: rehydration of the pelts with water, salt and possibly soap, followed by rinsing;
- fleshing: the rabbit skin has a peculiarity, a thin collagenous film on the flesh side. This membrane, which is impervious to

FIGURE 49

Correct way to dry rabbit pelts

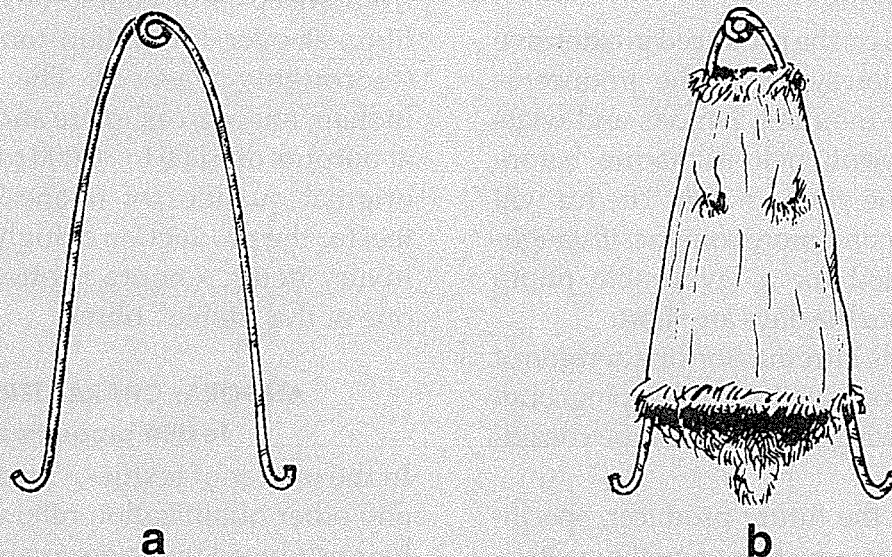

Note: a = frame of thick steel wire (6 mm) if possible covered with plastic or sticking-paper; b = skin stretched over frame to dry, turned inside out with frame on inside, held down by clamps or clothes pins.

curing products, should be removed.

This is a delicate, labour-intensive operation, carried out on the rehydrated skins;

- dressing: the special tanning for rabbit skins generally uses a specific blend of salt, alum and formol;
- thinning: it is necessary to thin down the thicker skins. This is highly specialized work, demanding great precision to avoid holes in the skin, cutting hair follicles and causing hair loss. A second dressing is carried out on the thinned skins;
- greasing: nourishing the skin with oil. This operation is labour-intensive;
- finishing: this gives the skin a pleasing appearance and consists of removing grease (stirring in a tub with absorbents), beating (tossing in a meshed cylinder to remove absorbents, sawdust, grit, kaolin) and lifting the hair to set it in place. Machines can be used for all three finishing stages.

### Glossing

This is a complicated finishing operation, with variations such as shaving or colouring according to the final product required. It calls for much handling, expertise and imagination (mixing of dyes, special effects, etc.). These operations are too complex to describe here. However, it is often the furrier who, having chosen a lot of rough furs, decides on the final appearance they will be given. For a coat, 20 to 30 skins will be needed. The making up of "bodies" (remnants of fur sewn together and sold by length), which is labour-intensive and not highly automated, can be done in developing countries or in countries where the labour is less expensive (Greece, the Republic of Korea and, for mink pelts, Taiwan, Province of China).

### CONCLUSIONS ON FUR PRODUCTION

There is no hope of supplying quality furs under current rational production

conditions for meat rabbits, particularly those slaughtered at 11 weeks. Skins, however, may be recovered for the three separate purposes of hair (felt), hides (fertilizer, glue) and sometimes dressed skins.

Quality pelts can be produced in extensive rabbit production systems if the producer is mindful of the moulting periods and waits until the subadult pelt is mature before slaughtering the young rabbit. The fur will be even thicker and more compact if slaughter is scheduled for a favourable photo period, i.e. when the days are short.

As regards the introduction or extension of rabbit production for pelts in developing countries, the following points should be considered:

- training of the future producer, specifically in the production of quality pelts;
- production of quality pelts in sufficient quantity to make up homogeneous lots for trade, concentrating on a limited number of pelt types, in particular as concerns colour;
- coat structure (density, silkiness) and the size of the skin are important considerations in selecting the breed. There is not much point in pinning great hopes on obtaining high-quality pelts in hot climates.

Upmarket furs can also be produced in rational systems provided special strains such as the Rex are used. The look and feel of this fur is now much in demand. There must be specific production techniques geared to fur production (meat, even though it may be of better quality, is here the by-product). Compared with conventional intensive production, the fattening units must be modified: windowless buildings for artificial illumination, large individual cages. The diet must also be modified (rationing) and slaughter specifically timed. Skinning, drying and preservation require great care. The skins are usually sold raw to furriers, for small-scale tanning operations often lack the qualities to produce high value added upmarket furs.

## ANGORA

Angora, the hair of Angora rabbits, is one of the five keratinic textile fibres of animal origin of significant economic value. Wool from sheep is of course by far the main fibre, at over 1.3 million tonnes per year (thoroughly washed). The four others: mohair, angora, cashmere and alpaca, each at outputs of 5 000 to 30 000 tonnes, exhibit original qualities of fineness, lustre and feel for the production of high value added luxury items. Angora is often considered one of the "noble" fibres.

### ANGORA: CHARACTERISTICS

#### Textile properties

In the matter of textiles, "angora" without any other qualification refers solely to the hair produced by Angora rabbits.

Its International Organization for Standardization (ISO) symbol is WA: W for wool, reserved for noble textile hair, as opposed to H used for ordinary hair. The letter A is for the Angora rabbit and distinguishes it from the mohair produced by the Angora goat, M. The symbol for mohair is thus WM. The short hair of the ordinary rabbit is designated HK (K = Kaninchen which is "rabbit" in German).

**Length.** Angora hair is unusually long owing to the prolongation of the active phase of the hair follicle cycle: the hair grows for approximately 14 weeks, whereas that of the rabbit with ordinary (short) hair grows at the same rate but for only five weeks. This is due to the presence of a recessive gene in Angora rabbits.

Apart from this great length, there is no other modification either in the hair's structure or in the composition of the coat, which contains the three classic types of rabbit hair.

- guide hairs: the longest (10 to 11 cm) and the roughest; they cover and guide the coat;
- guard hairs ("barbes"): shorter than guide hairs (8 cm); their rough points lie

on the coat and hermetically seal it (covering hair); four to each guide hair;

- down: shortest hair (6 cm); rounded point, hardly visible, very fine body (14  $\mu$ ). Very numerous, 60 to a guide hair, they constitute the thermic isolation undercoat.

The length of angora hair accounts for its textile value, because it permits cohesion in the thread.

**Friction coefficient.** The rabbit's hair has a characteristically low friction coefficient owing to the very slight relief of the cuticle scales. This results in a particular softness to the touch, but also an exceptional capacity for slipping. This is why the length of angora is important; the hair is twisted and stays in the thread. The use of ordinary rabbit hair to replace angora produces threads of bad quality which spread everywhere: this is a fraudulent process which reflects badly on the Angora industry.

Because of its softness angora hair is used for the manufacture of insulating underclothes (keratin). Ten percent angora in a mixture of wool, cotton and synthetic fibres makes an extremely soft fabric, very easy on the skin.

The kemp points and the covering hairs, which are more rigid, rise from the fabric, giving it a fluffy appearance which is much prized. Whole angora hairs obtained by depilation are the most suited for this purpose.

#### Other characteristics of angora hair

Although the Angora rabbit exists in all colours, only the albino strain is produced now. Its coat is entirely white, which is an advantage for dyeing. Coloured Angora rabbits are raised in India for the manufacture (by breeders themselves) of undyed artisanal fabric with muted colour motifs. The hairs are all medulated (hollow), which makes them lighter than wool (density 1.1 against 1.3) and increases their insulating

#### Mini-glossary

Selected technical terms for fur production

*Curing*: tanning skins with hair.

*Shearing*: separating the hair from the skin in which it is implanted.

*Knife marks*: perforation or slit from skinner's knife.

*Skinning*: separating the skin (with hair) from the animal (carcass).

*Brushing*: gently brushing hair back into place at various stages in the curing process.

*Pellicle*: a thin collagenous film on the flesh side. The subskin muscle is removed with the dermis during skinning.

*Fur*: rabbit skin and hair.

*Glossing*: dyeing the hair of cured pelts.

*Moulting*: period of reactivation of hair follicle. The base of the former hair is hydrolized, freeing the hair canal for the emergence of the new hair.

*Moulting zone*: section of skin where hair follicles were active at slaughter. Seen as dark blue patches on the skin side of the pelt. The hair comes out easily or is still very short, its growth interrupted by slaughter.

properties. They have all the properties of keratin, notably insulation, water absorption and good dyeing quality.

The Angora rabbit's coat is 98.5 percent pure as cutaneous secretions (restricted to those of the sebaceous glands) are very slight and the animal grooms itself frequently (a sheep's fleece is only 50 percent pure because of the presence of suint). Angora wool goes straight to the card without previous

washing: it is imperative that the producer keep constant control over the cleanliness of the animals.

#### Commercial qualities

There are several grades of hair, identified by length, type of animal and cleanliness. First-quality hair which represents 70 percent of the coat must be over 6 cm in length (down) and clean. This grade was worth 950 FF a kg in 1984, but only 300 FF in 1981 to 1982. Since 1988, the price has ranged from 300 to 380 FF.

Second-quality hair is clean but too short (down less than 6 cm) or too woolly. It is grown on the belly and extremities and is worth about 20 percent less than the first-quality wool. The hair of the young Angora rabbit is shorter and softer. It is the product of the first and sometimes the second collection. The clean but felted hairs collected on the necks of females or breeding animals are worth only 15 percent of the value of first-quality hair.

Dirty hair of any length is virtually worthless. At best, it is worth less than shorn hair from ordinary rabbit breeds. Its value would be no more than 5 or 6 percent of the first quality. Clean hair is therefore absolutely essential in Angora wool production.

#### RAISING ANGORA RABBITS

Angora rabbits are reared primarily for their hair. The production of this hair calls for an entirely different set of techniques from those used in meat-rabbit production. These techniques have historically reached the pinnacle of specialization in France, where the sole target has long been wool production, but some countries, headed by China, are now also developing this specialization.

**Sexual balance.** The adult female produces the hair: adult, because top-quality Angora is only produced from the third collection at nine months, and female because the female

produces more hair than the male – an average of 1 kg against 700 to 800 g for the male. Therefore the hair-producing stock is made up of adult females that are maintained as long as possible, with reproduction kept at a minimum. Gestation and especially lactation reduce hair production by one-third.

The number of breeding bucks is kept to a minimum. The proportion is only 2 or 3 percent in hair-production units. In France the males not destined for breeding are culled at birth, which hastens the development of the female young.

**Harvesting schedule.** The hair is collected every 90 to 100 days, when the follicles reach the resting stage and before hair starts falling, which would cause felting and reduce the value. The hair is cut with scissors or electric or manual shears, or collected by depilation. Depilation has long been the technique of choice in France, synchronizing the reactivation of hair follicles with a well-structured coat with good guide hairs. Since the 1980s French breeders have been using a depilatory fodder sold under the name Lagodendron<sup>R</sup> (Société Proval, 27 rue de la gare de Reuilly, 75012 Paris). With careful use of this product, rabbits can be shaved more quickly and easily and less stressfully. Scissors is the more common technique in China, with shearing more common in Central Europe and South America. French-type Angora rabbit hair is better collected by depilation, whereas shearing or scissors are better for Chinese or German-type Angoras. The differences between their genotypes include, *inter alia*, the simultaneous resumption of hair follicle growth in accordance with the collection method.

Angora hair must be sorted into the different grades at collection, which is the best time. A skilled operator takes about half an hour: less than 20 minutes and more than 45 minutes are both very rare.

FIGURE 50  
Comparative growth of hair types in Angora and common rabbits

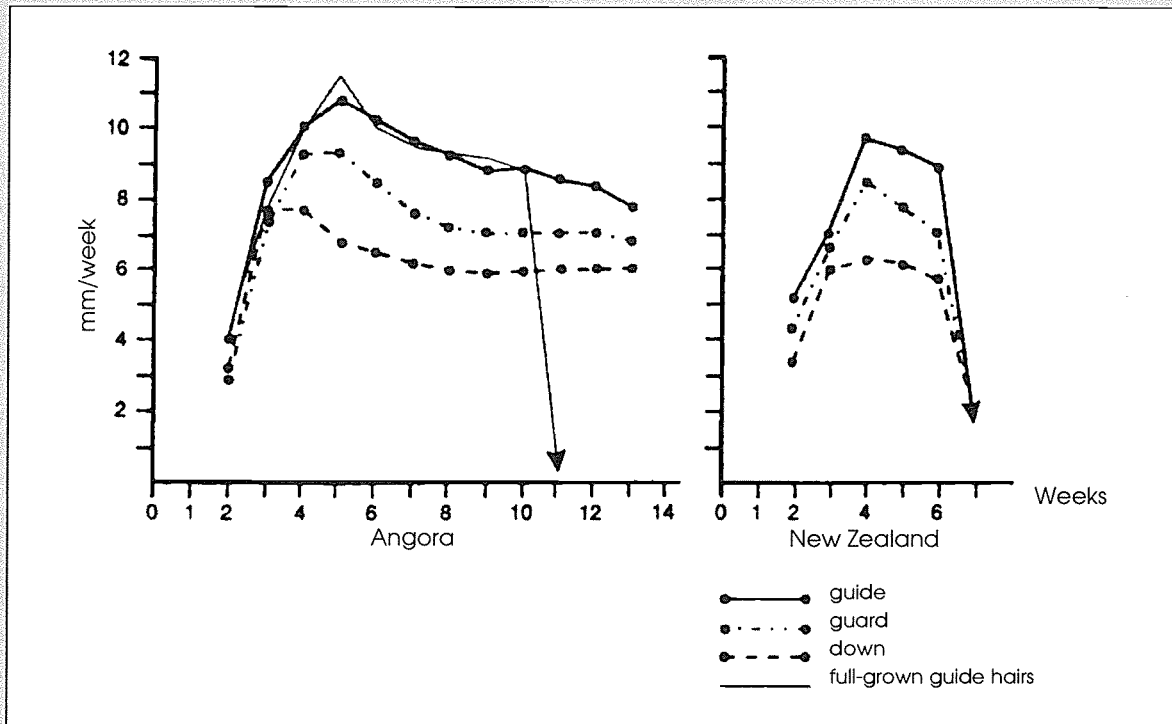

Source: Rougeot and Thébaud, 1984.

### Habitat

Angora rabbits must be reared in single cages, at least after the age of two months when the hair is first collected. The cage must be big enough (about 0.5 m<sup>2</sup>) and high enough (about 0.5 m). Wire-mesh floors are rarely recommended. Angora rabbits, particularly French ones, have very fragile paws for their weight of roughly 4 kg. As they are to be kept for several years it is better not to take chances.

French breeders have opted for cement hutches and straw litter, for clean hair and paw protection. The straw absorbs the urine. A little fresh straw is added each week and the entire litter changed every four or five weeks. Duckboard has been a frequent choice in other countries, with the slats made of bamboo (as in China) or plastic. Some breeders, for example in India, use German-type Angoras and have successfully raised them on wire-mesh floors as

for meat-rabbit production (see Chapter 6).

Angoras do not like high temperatures (over 30°C). Low temperatures are a problem as well (below 10°C), but only during the days following hair collection. It is therefore not necessary to heat all production buildings (in fact open-air production has long been the practice in France); on the other hand, the denuded rabbit must be protected, particularly where depilation is the collection technique. Breeders use several methods: two-stage depilation at intervals of a few days, leaving a "back" which is subsequently removed; body-coat, warmers, post-depilation boxes, etc.

### Feeding and hygiene

Feeding Angora rabbits involves several peculiarities compared with meat rabbits. Indeed, the Angora at peak production is an adult rabbit in a situation of maintenance from the physiological standpoint. Its

growth is complete and reproduction is limited to a few animals. It must, however, produce over 2 kg of dry proteins a year – more than 1 kg of keratin (hair) and the same amount from the internal sheath of the hair follicle. This is the equivalent of 7 or 8 kg of muscle.

This explains the need for a high-protein diet – 17 percent. The keratin in the hair is rich in sulphur amino acids, exporting 35 g of sulphur a year, so the proper intake of these amino acids (0.8 percent in the ration) must be ensured. The high productivity of modern Angora strains (up to 1 400 g per year), make full productivity difficult under traditional feeds such as hay, alfalfa, oats, barley, etc. The amounts would be excessive and deficits in sulphur amino acids inevitable. For cost considerations (excluding labour costs) some French breeders still combine these feeds with balanced concentrates containing methionine, vitamin and mineral supplements. Almost all breeders use only pelleted feeds for Angoras which are easy to administer. In this case an average 170 to 180 g should be fed to each rabbit daily.

The Angora rabbit's feed requirements follow the cycle of collection (every three months) and hair regrowth. Requirements increase after depilation as the animal is then hairless and energy losses by radiation are very great. By the second month the animal is again well covered, but this is when the hair grows fastest so the ration must of course remain adequate. In the third month, requirements decrease because the hair grows more slowly and, as collection time approaches, starts to fall. Daily rations need to be adjusted carefully to these variable requirements.

It is now the practice to give 190 to 210 g per day of dry matter during the first month, 170 to 180 g during the second month and 140 to 150 g during the third month. This is less imperative when the wool is sheared. It is also recommended that the rabbits not be

fed one day a week so the stomach can empty, preventing or at least diminishing the risk of the hair balls that can form from self-grooming (very hard balls called trichobezoars that obstruct the pylorus and usually end in death).

Most losses of adult Angoras occur during the days following hair collection as the animals then have problems maintaining thermal balance. They become particularly sensitive to respiratory germs (pasteurella, coryza, etc.). The breeder must therefore be constantly on the alert regarding their general hygiene (frequent litter renewal, cleaning, disinfecting). Having to replace working females with young does lowers average production levels because first-year Angora output is appreciably lower: 650 g compared with 1 kg. The usual yearly rate of renewal is 25 to 35 percent.

#### Labour

Labour in Angora rabbit production may be subdivided into five categories:

- feeding;
- hair collection;
- cleaning and disinfection of the buildings;
- curative or preventive health care (vaccinations);
- reproduction.

*Feeding* is not labour-intensive provided the breeder distributes only balanced pelleted feeds in easily accessible feeders. In this case 40 minutes per day and 210 hours per year would be needed for a production unit of 400 Angora rabbits. The time is doubled for coarse feed such as hay and cereals. A daily distribution of straw or roughage, including fasting days, transport and sifting of feed must be reckoned in, raising the time spent on feeding to 400 hours per year.

*Hair collection* is the most time-consuming operation. The calculation needs to include not only the actual hair removal by



shearing, cutting or depilation but also moving the rabbit from its hutch to the collecting table, the grooming phase to remove filth or plant matter from the coat, weighing different grades of hair, keeping records, returning the rabbit to the hutch, plus postharvest thermal stress reduction measures. All in all, some 1 000 hours per year are required for a 400-rabbit production unit.

*Complete litter removal* (cleaning) for hutches or cleaning out wire-mesh cages, disinfection procedures and sweeping takes at least 250 hours per year.

*Veterinary care* is basically preventive: vaccinations and general disease prevention can take up to 175 hours per year.

*Reproduction-related work* (handling breeding animals, checking gestation and kindling, sexing newborn rabbits, weaning) also requires 175 hours per year.

In all, a production unit of 400 Angora rabbits requires 2 000 working hours per year under rational production conditions.

## SOURCES OF VARIATION IN ANGORA HAIR PRODUCTION

### Genetic estimates of different strains

Although there are several strains of Angora rabbit, only the German, French and Chinese (Tanghang, Wan, etc.) strains are of economic interest at this time. The Chinese strains (including the German strain reared in China and South America) supply over 95 percent of the angora hair sold in the world. The European, French and German strains deserve mention for their specific features and because they have been selected for over 50 years.

**Weight production.** Hair-weight production has long been the sole focus in Angora rabbit selection. These genetic improvement efforts in France and Germany have produced highly similar acceleration of hair growth.

The annual output of does at the INRA experimental production unit in France rose

from 885 g/year in 1980 to 1 086 g/year in 1986, a phenotypical gain of 31 g/year. Animals tested at the *Neu-Ulrichstein Hesse Centre* in Germany gained in productivity from 400 g/year in 1945 to 1 350 g/year in 1986: a phenotypical gain of 32 g/year. Production in the French and German commercial sectors lagged slightly behind these figures with an estimated annual production per doe of 1 000 g/year under French and 1 200 g/year under German production conditions.

There are major gaps in China by province and by production systems. The figures range from 261 g/year (unspecified Chinese strain, 1985) to 815 g/year (Wan strain, 1992) for does. Production conditions, particularly feeding, are highly influential because German rabbits under Chinese conditions are, according to the literature, producing from 422 to 820 g/year.

### Non-genetic factors in quantitative hair output

Most of these factors are known today. The most important, judging by weight at each collection, is of course the interval between two collections. This effect is attenuated when considering annual output.

The collection technique (shearing or depilation) is an important factor, particularly for the (depilated) French strain, as shearing reduces adult doe productivity by about 30 percent.

The number of the hair collection is important up to the fifth collection for French strains: the first four collections successively represent 11 percent, 60 percent, 81 percent and 93 percent of adult production. The German strain is apparently more precocious, with several references citing the fourth and even the third collection as representing full potential productivity.

The sex factor is very marked in the French strain: male rabbits produce 20 percent less hair. This is not so true of the German strain,

where the literature reports a difference of zero to 15 percent, with most citing a figure of 10 percent less for male rabbits. Live weight is fairly irrelevant, except during the growth period, but should be correlated with the collection number (first, second, etc.).

The seasonal factor should also be taken into account: winter collection is always heavier than summer collection, varying by 4 to 30 percent depending on the author. It does seem that the higher the productivity of the strain, the weaker the seasonal effect.

Other variation factors such as the season of birth have been studied, but new data are needed to confirm these findings. Undeniably, other factors such as diet (deficiencies), temperature and comfort do have a direct influence on quantitative productivity of hair.

#### **Non-genetic variation factors in qualitative hair production**

Angora hair quality parameters are length, the fineness of the down, guard-hair diameter and fur structure and composition. Concerning this last point, the basic distinction is between woolly fur and fur thick in guard hairs. The latter, in accordance with the proposed classification presented to the 1992 Corvallis Convention, include those in which over 70 percent of the guard hairs are full (i.e. with pointed ends) and where less than 1 percent of the fibre is shorter than 15 mm. The other furs are considered woolly. Felting or dirty fur is also considered a quality parameter.

The interval between hair collections is a decisive factor in hair length.

In the distinction between guard hair obtained by depilation and woolly hair obtained by shearing, the collection procedure is fundamental.

The number of the collection is important (at least at the first harvest) for all rabbit strains and for the second and third collec-

tions in French strains, where the young rabbits still produce woolly fur, even after depilation.

The sex factor is less of a distinction and is weaker in the German than in the French strain but males do show a more marked tendency towards felting.

Live weight and season have less effect in adults; at most there is a structural difference: the length ratio of underfur to guard hair is less in summer than winter: 55 percent in summer as opposed to 65 percent in winter.

#### **PROSPECTS FOR ANGORA WOOL PRODUCTION**

A point to be considered very carefully is that Angora rabbit production is labour-intensive and also requires great expertise. The slightest mistake can mean the loss of productive adults: the animals have to be over a year old to return a profit. Hair collection is always a delicate operation and careless sorting irredeemably downgrades the product. Above all, not all climates are suitable: excessive heat and intense light (albinos) are very bad elements. In cold countries, or in countries with cold winters, the solution is to use buildings that shelter the animals against the rigours of the winter. Recently denuded animals require special care, however. The feed requirements of Angora rabbits are important: a poor, deficient diet will always mean qualitatively and quantitatively poor hair production.

Last and probably most important, the price of angora wool fluctuates: first, according to fashion, with a cycle of three to five years, but also and more abruptly, in classical supply and demand terms, when world production is structurally either excessive or insufficient compared with average utilization of the fibre. The price of angora (sheared wool) suddenly doubled between 1976 and 1978 (from US\$13 to \$28 per kilogram) because world production,

estimated at 900 tonnes in 1977, was clearly insufficient. The price remained at this high level for about ten years, following the dollar; up to US\$45 to \$50/kg, and then in 1988, when world production had increased by a factor of ten to 9 000 tonnes, the market collapsed and the price had fallen to US\$20/kg by the summer of 1991. There was a recent reversal of this slump in Chile, Argentina, Hungary and France (and China to a lesser extent), bringing the price up to US\$30 in 1992. The volumes traded, and hence angora utilization, continue to rise: the production figure is likely to reach 10 000 tonnes per year again.

As for France, the only developed country to have maintained an angora output of original quality (the guard hair), the situation is one of unprecedented crisis. Production costs no longer permit the sale of French angora wool at less than US\$75/kg and the gap between that and the world price appears

immense to foreign buyers (the difference between world prices and the price for French angora conventionally being 40 to 50 percent). Quality French angora hair has remained virtually unexported since 1988, therefore, and is very difficult to market internally, either in the unprocessed form for manufacture or in manufactured form (e.g. sweaters).

Clearly this is a highly speculative production and should be approached with great caution. The utilization of the noble textile fibre, angora, continues to grow despite competition from other natural fibres and particularly from synthetic fibres. This is partly due to the new sectors that have opened, particularly for fabric, in combination with cashmere and silk. The price slump from 1987 to 1991 did indeed follow ten very favourable years, after decades of good angora prices. Better times could return again.



## Chapter 9

# Rabbit breeding and rural development

The objective of this chapter is to present a case-study to show how rabbit production can help close the protein gap and raise the incomes of rural and suburban people in a great many countries. No attempt will be made to provide formulas for success – the various technical choices to be made will depend on the environment into which the rabbit is introduced. Instead the case history is used to demonstrate the questions that need to be asked in designing a programme like this and to determine the support structure needed for successful development in a traditional rural environment.

Generally speaking, the first task is to examine the external components of this kind of production system. There is a historical component, an environmental component, an animal component, a human component, and the socio-economic components (agriculture and stock-raising in the country, agrarian structure and industrial rabbit production). The interrelations among these various components should also be studied. They will reveal the advantages and constraints represented by rabbit production in reaching the objective: using local resources to supply animal proteins to rural families.

Next, the support structures and services available for development projects need to be investigated.

All these factors in combination comprise a community-level production system. Can the initial objective be attained? What are the potential bottlenecks? The components of a “model” programme tailored to the local circumstances should provide the answers to these questions.

### THE MEXICAN “FAMILY PACKAGES” PROGRAMME

Mexico has been chosen for the case-study analysis because it is unquestionably the country which has approached the problem most fully and systematically.

The example used is the *Paquetes familiares* (family packages) programme developed in Mexico by the *Dirección General de Avicultura y Especies Menores* (DGAEM). This rural development activity uses several backyard animals, including rabbits. The aim is to develop the production of poultry (chickens, turkeys, ducks), rabbits and bees, using local resources to produce quality animal proteins and honey, mainly for home consumption. The eventual marketing of products and by-products will raise community incomes.

Assisted by several rabbit production centres, the Mexican programme has a threefold mission:

- to inform producers, teach them all they need to know about rabbits, make them aware of the potential of rabbits, and draw the attention of the media to these actions;
- to train future breeders and experts/extension workers by teaching them the fundamental technical operations, making it clear that rabbits are not reared the same way as chickens;
- to produce the breeding animals Mexico needs for both industrial and backyard rabbit production.

In support of this programme, DGAEM conducts a number of experiments at its centres to test production techniques, installations, equipment and feed formulas in local conditions. The production techniques

developed in these centres are then introduced into the target rural communities.

**Historical background.** The wild rabbit found in Mexico belongs to the genus *Silvilagus* Gray. There are several species – *Silvilagus andubonii*, found throughout most of Mexico; *Silvilagus brasiliensis*, in the southeastern part of the country; *Silvilagus floridanus*, in central Mexico; *Silvilagus bachmani*, in Baja California; and, last, the Zacatuche, in the volcanic zone.

The wealth of names reveals how important this animal was in the past. Among the Aztecs, Tochtli (rabbit) is the eighth of the 20 signs central to the Aztec calendar. This monumental stone is far more than a simple calendar: it is a compendium of their cosmological view of the world. Tochtli had relations with Xipetote, the goddess of agriculture and good harvests. He was also the symbol of fertility. In the cosmogony he descends from Mextli, who represented the moon. The peoples of Central America saw a rabbit in the dark parts of the sky around the moon. Ometochtli (two rabbits) is the god of “pulque”, the god of intoxicating drinks.

Despite this sometimes alarming symbolism, Fray Bartolome de las Casas in his book *Los Indios de México y Nueva España* reports that pre-Colombian peoples used rabbit skins for clothing and appreciated how well they kept out the cold. Rabbit meat was also eaten. Cortez’s soldiers saw rabbit meat in the great markets (the famous *tianguis*), especially in the Aztec capital. The Spaniards later imported domestic rabbits of the species *Oryctolagus cuniculus* (Linnaeus, 1758) for the backyards of their *haciendas*.

Eating habits have regressed. Nowadays rabbit meat is unknown to most Mexicans. The individual intake is less than 100 g per person per year. In 1975, of the 127 people’s markets in the Federal District only three had stands offering rabbit for sale. It is

found on some weekdays in some supermarkets. Consumption is therefore limited to a small fringe of the urban population, especially in the Mexico City area (often people of European origin). Most Mexican people have never tasted rabbit meat. This unfamiliarity can make them suspicious or even hostile towards it.

**The environment.** *Oryctolagus cuniculus* is well adapted to the agroclimatic complex of its area of origin (the entire western Mediterranean). In the natural environment encountered in Mexico some areas are more favourable than others. Mexico is a tropical country lying north and south of the Tropic of Cancer. Its relatively large size (1 970 000 km<sup>2</sup>), impressive relief and mountain plateaus and the distance from north to south (about 2 000 km) explain the variety of climates and landscapes. The different combinations of latitude and altitude allow one to pass from a cool, temperate climate to a wet tropical one within a distance of a few hundred kilometres.

There are several large systems. In the centre a plateau area, the Altiplano, stands 1 000 to 2 500 m above sea level. The climate is pleasant and healthy. Temperatures range from 15° to 25°C, and the difference between day and night temperatures is considerable. A dry season alternates with a wet one of the same length. Northwards, the dry season lengthens. The plateaus change, sometimes into true desert (the Great Sonora, Baja California) and sometimes into great, closed depressions dotted by oases. Further south the humid season is longer. The two mountain chains (the Sierra Madre) surrounding the plateaus converge to form a complex, low mountain system.

To the east the plateau slopes down to the Atlantic in a series of steps well watered by the humid winds, especially in the south. The further one goes the wetter it gets. The plains become semi-aquatic in the state of Tabasco.

The next region is Yucatán, a calcareous peninsula with shrubby vegetation.

The Pacific side to the west is a much steeper formation of crystalline rock. Well watered to the south, it is semi-desert in the north.

In this mosaic of agroclimatic zones that make up Mexico the rabbit prefers the temperate or cool zones of medium rainfall – the high plateau and the Atlantic or Pacific slopes. As rabbits need a certain amount of water and forage their adaptation to the desert and semi-desert zones would pose some problems. Rabbits also dislike heat more than cold. So the lowest, hottest areas have to be avoided.

However, trials in Colima, which has a hot, wet climate, show that the species has considerable potential for adaptation. Studies now under way should enable potential production areas to be better specified in the future and, possibly, the selection of genetic types adapted to these tropical zones. These factors emphasize the importance of local genetic types, where found.

While not every agroclimatic zone in Mexico is favourable for rabbits, some can be exploited in creative fashion. The “family packages” used by the DGAEM programme usually contain the species or combination of species that will achieve the target objective. These associations (turkey-rabbit, chicken-duck or turkey-bee, etc.) would be even more effective if reinforced with small ruminants such as goats or sheep or a monogastric species such as the pig. There are one or more combinations of domestic animals for each agroclimatic zone, the goal being to make the rural community self-sufficient in animal proteins by maximizing the local natural resources.

**The animal component.** Worldwide, rabbit production is fairly extensive. Rabbits are found in almost every climate. The use of local breeds, where found, should be promoted. The direct introduction of selected

animals into production systems should be discouraged. These animals probably do not possess the necessary adaptability and also the strains almost all derive from just two breeds: the New Zealand White and the Californian. When imports are unavoidable, the rabbits should not be introduced directly into the rural environment, but rather studied for one or two generations in experimental stations where their reactions to their new environment can be observed.

**The human component.** The extraordinary population explosion in Mexico over the last few decades is both an advantage for the future and a serious problem. The population was 13 million in 1900. It doubled in 50 years and stood at 26 million in 1950. Twenty-two years later it had again doubled. Today the 80 million mark has been passed and a figure of 111 million will doubtless be reached by 2010.

Demographic pressure is stronger in the rural areas. The outcome is a general rural exodus, amplified by a large emigration flow to the United States. Between 1960 and 1970 the active farm population shrank by 15 percent in relative terms. At the same time it also increased in absolute terms. The problem of undernourishment in these areas therefore continues to grow more acute.

**Socio-economic background.** A look at Mexican agriculture is necessary to see the programme in its proper context. A historical footnote on agrarian reform is followed by a brief description of industrial rabbit production.

**Agrarian reform.** Agrarian reform began about 1910 during the Mexican Revolution, with the establishment of the *ejidos* (collective farms). *Ejidos* were either old rural communities whose former lands were restored to them, or *haciendas* (large estates dating from colonial times) confiscated and turned over to the farm labourers and tenant farmers

working them and run as cooperatives. The process is not complete even today as there are still landless farmers in many areas. Of the arable lands 25 percent are still in the hands of landowners with more than 1 000 hectares. Despite the existence of laws protecting productive properties, the risk of expropriation holds investments to a very low level on these estates.

Each *ejido* member also received a collection of plots, but these proved to be too small. The farmer can grow enough maize and beans to feed his family, but that is all. Only one of his sons can succeed him; the others have to go elsewhere. Numerous efforts have been made by the government to finance the *ejidos* with non-agricultural capital but most of these have failed.

*Mexican agriculture.* The traditional Mexican diet consists of tortillas (thin, flat, unleavened maize cakes), red beans and pimientos. Long a grain exporter, Mexico has become an importer in recent years.

The growing consumption of animal products, especially in the cities, conceals the stagnation or even regression in meat consumption in rural areas. Agricultural output lags behind population growth. This is in part a result of the existence of a vast sector that is underproductive: 3.5 percent of the land supplies 54 percent of all agricultural production, while at the other extreme 50 percent of the cultivated land supplies only 4 percent of total output. Despite this Mexico still has great reserves: 3.3 million hectares could be added to the 24 million hectares of agricultural land.

The government seems determined to develop this potential by the reasonable exploitation of its oil profits. It is aiming at national food self-sufficiency before the end of this decade, and the *Sistema Alimentario Mexicano* was launched for this purpose. This is an ambitious goal. The unemployment figure resulting from this and the population growth should be noted here. Underemployment is chronic in the countryside.

The Mexican peasant works an average of four months a year and the rest of the time cannot find any employment. Some try to improve their lot by doing several seasonal jobs.

*Industrial rabbit production.* Industrial rabbit production differs from the rural variety mainly in its objectives, which are to reap a profit by producing animal proteins for urban markets.

In the early 1970s some thought rabbits had a great role to play as suppliers of animal proteins for the steadily growing urban population swelled by the drift from the land. Entrepreneurs with capital to spare invested in rabbit production. They started by importing breeding animals and then marketed them. The market developed rapidly and many rabbitries sprang up.

At this point a number of negative factors began to emerge. The extremes of the climate had a depressing effect on intensive production. For better environmental control, costly buildings had to be constructed. Breeder expertise was scanty. There were serious problems with the feed because of the poor quality of the raw materials and the small amounts manufactured. Growing production costs were masked by the profits from the market for breeding animals. However, this market dried up in the end, so advertising campaigns were then mounted to stimulate the demand for rabbit meat.

Unfortunately there were no marketing structures. Supply and demand were never able to balance. The resulting instant overproduction caused a price slump. As production costs were high, many units closed down. Production dropped and demand was never met. The crisis dealt a lethal blow to the recently formed producers' organizations. They disappeared before they had had a chance to organize the market or reduce the number of negative factors. Neither of the two objectives was met, but industrial rabbit production did not



disappear and continued throughout the 1980s. Colin (1993) believes there are several dozen rabbitries with 200 to 3 000 does, and many more with about 30 does. The sector is thought to produce about 2 500 tonnes of carcasses every year. Marketing systems favour home consumption and local markets. Mexicans sometimes eat rabbit in restaurants. Promotional efforts are frequent.

#### **Advantages and drawbacks of rabbit production in rural Mexico**

*The objective.* Rabbit protein production corresponds to different needs. In the earlier example, the object was to increase producer income and it led to the development of techniques to maximize output while trying to hold down costs. These two goals are hard to reconcile. Some producers choose to hold down costs, especially investments, and try to maximize output regardless. Rabbit production thus fulfilled a luxury market: the eating habits of the tourists swarming through parts of Mexico every year encouraged restaurants to broaden the menu.

But the need in the countryside is a vital one: the diet is heavily deficient in animal protein.

The level of need and what attempts are being made to satisfy it is the next question. There are four levels: the farm family, the village, the city and the nation. Needs at individual and village community levels are easy to meet. Home consumption by farm families offers all the advantages of short producer/consumer marketing circuits: bottlenecks in processing and marketing disappear.

At the urban level, one feasible solution would be industrial production on the outskirts of towns. Several problems arise: technical management of large-scale units must be mastered. Obviously, since technical problems easily outstrip the size of production units, the size barrier is soon reached.

Rabbit marketing also needs to be organized: the people it is planned to supply must actually buy the product through existing channels. At the national level, there may be other justifications, such as foreign exchange from rabbit exports, as in Romania, Hungary and China.

*Rabbit production in rural Mexico.* The first advantages of raising rabbits in small rural units are the intrinsic qualities of the species: its prolificacy, the quality of its meat and its faculty of adapting to varied environments. This last trait should be fully exploited in small units where mistakes will not entail the same drastic consequences as in large units with several hundred does.

The rabbit is a small animal. It requires few inputs (purchase of initial stock, buildings, etc.) and it is the right size for home consumption. It can be reared by workers lacking great physical strength: women, children and old people. It therefore allows these categories to be part of the family labour force.

Fibrous feed is an important part of the rabbit's diet, so it does not compete directly with humans for its food. This feature makes it highly complementary to other backyard animals (chickens, ducks, turkeys) or small ruminants (sheep, goats). It will make use of forages not otherwise used, kitchen and other wastes and so on. In addition to its meat it supplies certain useful by-products such as skins and excrement. Processing the skins could provide a little employment for rural labour. Tourism should provide an outlet for these products. In the Mexican climate, earthworms can be used to convert manure into fertilizer. This is a fairly important resource in areas where chemical fertilizers are virtually unknown.

However, there are disadvantages. Despite their adaptability, rabbits need a minimum of water and green or preserved forage and do not withstand humid heat very well.

Where rabbits are reared in cages their forage must be gathered and distributed. Rabbits cannot seek their own food like other domestic animals.

Rabbit is not a customary item in the Mexican diet. With some exceptions Mexicans are not acquainted with this meat and are often reluctant to try it.

Technical personnel trained in rabbit production are lacking. Even if the owner of a small unit can manage with labour that is not skilled, a certain minimum number of technical operations need to be mastered. A rabbit is not reared like a chicken, so rural producers have to be trained. They also need to be assisted with the technical problems that can crop up periodically: health and reproduction problems and so on.

Making good use of the advantages offered by the rabbit implies knowing more about the animal: its requirements *vis-à-vis* the environment, rearing techniques and the products it supplies. Another prerequisite is the availability of motivated labour.

#### **The DGAEM: an action agency**

This agency has been working with rabbits since 1969, but also works with many other species: chickens, turkeys, ducks, geese, bees and pigs. The family packages programme was developed in cooperation with other development organizations. The rabbit component of the programme covers information, training in technical expertise and extension, the production of breeding animals and technical assistance to breeders. DGAEM has its headquarters in Mexico City and numerous production centres throughout the country. The Irapuato National Rabbit Breeding Centre (State of Guanajuato) was set up in 1972. This is the only centre specializing in rabbit breeding; the other centres breed other animals as well as rabbits.

At the national level, information is prepared by a special department of the DGAEM.

It issues brochures, reviews and other publications as well as audiovisual aids and any other appropriate teaching material to inform and interest farmers. It also assists other national and regional development agencies using the livestock species in which DGAEM specializes. It participates in agricultural and livestock fairs and keeps in contact with agencies abroad involved in the same work. A leaflet designed and drawn up by this department is published here to illustrate the work it does (Figure 51).

Promotion at the rural community level is the responsibility of a technician who usually works for another organization but has been trained in one of the DGAEM centres. This promoter is the key element in the field programme. The first step is to present the programme to municipal or, *ejido* authorities, explaining clearly the origin, development and aims of the programme and the benefits it offers the population. The promoter then organizes public meetings, visits families in the community and hands out the information documents provided by DGAEM, trying to enlist the cooperation of local primary or vocational school teachers. Experience has shown that children are very good at persuading their parents to accept a family package.

The promoter makes a list of interested families and with them examines how the family packages can be paid for. There are two ways of paying, in cash or in kind, with deferment for one year. For a package of one male and five does the farmer can pay back the same number of animals or seven dried skins. A community representative collaborates with the promoter and acts as guide on visits to the production units.

In addition to their technical training these agents have been taught communication techniques. A few simple ideas help them in their work. Every message seeks to produce a change so its purpose must appear clearly. The manner in which the person receiving

FIGURE 51

Example of leaflet circulated in Mexico for the promotion of rabbit production

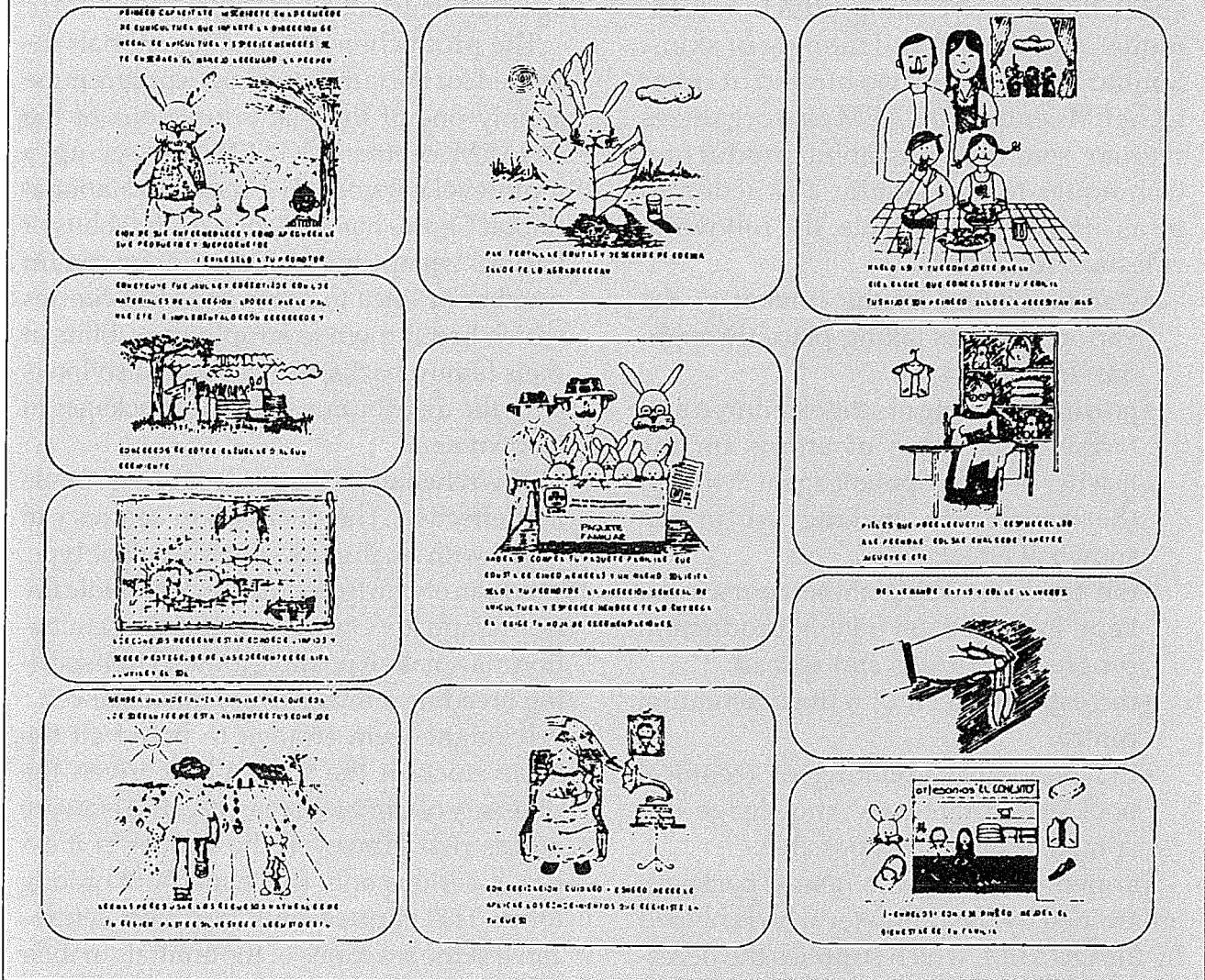

the message interprets it depends on their skill in communicating, their level of knowledge and sociocultural environment. So the information should be as accessible as possible to the person for whom it is intended. The one issuing the message should make its purpose stand out clearly, choosing the most appropriate medium, from the leaflets, tapes, slides, films, posters, cinema and television available, each of which has its own advantages and should be carefully combined.

Feedback is not overlooked. Public reaction is important as it enables some details to be corrected and shows whether the objectives are being met. The number of fami-

lies in a community who have asked for family packages is a good yardstick of success. The evaluation process continues throughout the programme.

Training and extension in the family packages programme works on two levels: training the promoters who in turn train the producers. This is essential as DGAEM cannot afford direct training for all breeders receiving family packages.

Promoters are trained at the DGAEM centres in all livestock species handled by the programme. There are over 25 of these centres in the country. Courses are about 60 percent practice and 40 percent theory. The Irapuato course, for instance,

lasts three weeks. This centre can take up to 50 students, including 30 boarders. The general course alternates with more specialized courses on production techniques and the use and tanning of skins. Similar courses are also offered at other DGAEM centres. DGAEM also organizes regular seminars on rabbit production techniques for the public. For action to be as effective as possible, the following rules are followed:

- standardization of the content of the various courses taking place throughout the country;
- no direct training of schoolchildren and farmers but focus of efforts on the teacher or development agent acting in the community, making use of the snowball effect;
- the teachers taking these courses are kept informed on rabbit production progress in Mexico and abroad;
- the establishment of a documentation centre;
- the periodical updating of technical booklets so that new knowledge can spread as quickly as possible.

Farmers receiving the family packages are trained by the promoter who is helped by the DGAEM, which supplies the necessary teaching materials. The promoter also offers direct assistance to families whenever the need arises. Particular attention must be given to the crucial stages of the programme:

- construction of cages and shelters;
- arrival of animals;
- feeding;
- mating;
- birth and weaning of young rabbits;
- fattening and slaughter;
- consumption of meat by producer's family;
- utilization of by-products.

Every month the promoter sends comments to the DGAEM centre which supplied the animals. The centre can then help

if difficulties arise, such as a serious health problem. During the first year of operations an expert from the centre visits family package recipients once a month.

The production of breeding animals intended for the family packages programme is only one of the many functions of the DGAEM centres. DGAEM has set up a multilevel network. The Irapuato National Rabbit Centre has 1 500 breeding rabbits of various genetic types. It provides a certain number of lines to other DGAEM centres which breed them to supply the rabbits in their family packages. Irapuato also looks after the distribution of family packages in its own area.

This scheme has the merit of being simple and effective. The distribution centres can get by with small stocks of each genetic type. They can obtain fresh stud stock periodically from Irapuato. One day, artificial insemination may make it possible to avoid transporting breeding animals over long distances.

It might seem strange to breed all the basic stock in the same place, given the diversity of climate areas. DGAEM is aware of this risk. However, the danger, if it exists, is serious only in the medium or long term. The various multiplication centres can test the reactions of the animals in their climatic environment and these animals could, if the need arose, constitute a core stock to begin setting up regional lines.

A centre the size of Irapuato has technical problems which are hard to overcome. Any country wishing to establish such a network should first acquire experience with medium-sized units before designing the central unit. Original solutions have enabled such problems to be very largely overcome in Mexico.

The Irapuato centre is first of all a production centre for breeding animals. It supplies pure-bred animals for other centres for multiplication and pure- or cross-bred animals, as needed, for the family packages.

Irapuato is also an experimental centre.

One of its tasks is to constitute Mexican rabbit lines. To do this it has had to identify the animals (tattoo breeding animals, tag animals temporarily at weaning), organize performance checks (record litter size at birth, at weaning and at 70 days, as well as individual weight at weaning, at 70 days and at first mating) and process and utilize all these data. Production quality is a constant concern of the people in charge of the centre. This requires a meticulous review of all technical constraints and skilful organization of centre operations.

Staff activities are programmed on a weekly basis: weaning on Mondays, selection of future breeding animals on Tuesdays, palpating on Wednesdays, etc. Certain operations are done every day (feeding, inspection of nests). Such specialization is more efficient.

To facilitate the organization of the work, each doe is assigned a card. A system of colour-coded clips and pigeonholes in which to place these cards makes possible the simultaneous management of all females at the same physiological stage. Each buck and each litter have cards listing their productivity in weight and numbers. These cards are not only useful for the immediate management of the animals, they also help to choose the breeding animals to be culled and the stock to be used for replacement.

Production evaluations are made monthly in each building in the centre. These data are processed in the centre and sent to DGAEM headquarters in Mexico City. Each centre around the country sends in a monthly production balance sheet. The analysis of these monthly reports is extremely important for dealing with the technical problems arising in units of this size. Problems can be pinpointed rapidly, the causes analysed and attempts made to remedy them.

Irapuato is located on the Altiplano at 1700 m above sea level. The altitude tempers the effects of the tropical climate. Temperatures are relatively high. Diurnal variations

are considerable, from 16° to 30°C in summer and from 8° to 25°C in winter. The dry season, October to May, is about the same length as the wet season. Rainfall often takes the form of storms that cause major swings in humidity, which can shoot up from 40 to 95 percent. The buildings have been designed and improved to offset these climatic swings as much as possible.

A conventional pelleted feed is given to breeding and fattening animals. Its use has led to a better understanding of some of the shortcomings mentioned in the section on industrial rabbit production. This feed is brittle and tends to crumble. Its fibre and nitrogen contents are far too variable.

The causes of these defects are many: uneven quality of raw materials, small quantities produced, which stops the feedstuffs manufacturers from making needed investments and so on. The problem of pelleted feed quality is one of the major barriers to technical success in large units such as the Irapuato centre. The animals could be fed green forage, but this solution has not been considered because it is labour-intensive. There is also no guarantee of the quality and reliable supply of forage.

In units the size of Irapuato poor control of animal health would soon lead to catastrophe. With some exceptions, individual treatment is seldom satisfactory in large-scale production and is very costly. The answer is prevention, with the focus on the group, not the individual animal. Constant attention is therefore given to preventive hygiene:

- regular cleaning and disinfecting of equipment and buildings;
- daily removal of dead animals, quarantine of sick animals, rapid examination of breeding animals at each mating;
- avoiding stress and contamination by personnel or inopportune visitors;
- control of other live vectors of contamination;
- regular analyses of feed composition and bacteriological quality of the water.

There are several types of rabbit in Irapuato. Three are crossed to make up the family packages. These rabbits were imported during the 1970s and their performances are highly satisfactory. They have adapted well to local production conditions. Mass selection is practised. The least-productive animals are culled and future breeding animals chosen from the litters of the best females.

In the New Zealand White and Chinchilla strains the standard criterion is the number of weaned rabbits per month of production. All the does in a building are entered on a double-entry worksheet (Figure 52). After each weaning the keeper changes the position of the doe on the card. Does on the left-hand side of the sheet are to be culled as soon as possible; those on the right-hand side will produce the young replacement females and on the far right the replacement males. Culling and selection will be determined on the average level of production, to keep a constant total in the herd. The offspring of does in the central section will be for distribution to other centres and for family packages. The Californian strain is selected in the same way. The main criterion is growth rate between weaning and 70 days.

Reproduction is not intensive (mating 17 days after kindling; weaning at 42 days). Various experiments at Irapuato have shown that this system best reconciled quantity and quality under variable environmental conditions and where factors of production were not fully under control.

The organization of matings under one roof makes some selection possible while avoiding a too rapid increase in the average coefficient of inbreeding. To achieve these two conflicting goals each building is divided into breeding groups and matings are scheduled between these groups. This frees the keeper from having to check to see if the animals to be mated are related.

In the family packages a cross-bred female

is included, say a Chinchilla x New Zealand White genotype. She will be supplied to the producer with a Californian male (Figure 53). This cross offers the advantage of heterosis. With several genetic types, numerous combinations are possible. Some are now being evaluated at Irapuato and in the family packages programme. The multiplication centres do not keep much stock of each genetic type. They receive Chinchilla and Californian males regularly from Irapuato. Basically these centres multiply New Zealand White females.

*Liaison with other development organizations* is necessary because DGAEM cannot provide technical support for each family package distributed. The promoters and extension agents who are indispensable in linking DGAEM to the rural communities belong to other organizations for this reason.

A programme such as family packages is just one component of an overall rural development strategy, itself a component of the national development plan. A global programme has to consider all the rural social questions of housing, health and hygiene, cultural activities and education. The promoter needs to integrate these components. To be effective, action must focus not at the family level but at the village community level. The fact that there are so many activities demands close coordination among the various bodies. While a simple administrative body may be inconceivable, a flexible support and coordination unit within an overall programme including family packages seems essential.

Promoters thus require multiple training. In addition to strictly technical matters they must be conversant with other, non-agricultural fields such as hygiene and pollution control. Moreover, if they are to get their message across, they must have some rudiments of the social sciences.

DGAEM officials are well aware of these

FIGURE 52

Example of worksheet used for selecting does according to numerical productivity

		Number of rabbits weaned/does/month of production			
		Fewer than 1.8	1.8 to 3.4 (average = 2.5)	Over 3.4	Over 3.9
		CULLING	PRODUCTION	SELECTION	
Months of production since 1st kindling	4				
	5				
	6				
	7				
	8				
	9				
	10				
	11				
	12				
	+				

Least-productive females to be culled as soon as possible
Working females (these females are kept but none of their offspring are)
Females whose sons will be kept to renew bucks

Females whose daughters will be kept to renew dead or culled does

Note: This sheet is used in a unit producing a yearly average of six litters of five young each per doe. At each weaning after the second, the doe's tag number is repositioned in the area corresponding to her average output, taking the date of her first kindling as the base time zero.

two essentials – coordination with other development organizations and technical training for promoters – but there are many problems that have not yet been solved in practice. The failure of the family packages programme in some communities has been the result of inadequate training for promotion and poor coordination with the DGAEM centre supplying the animals.

When the promoter has finished the publicity campaign he or she visits each interested family, noting their resources and the time they have available. The final list of applicants is then drawn up and sent to the director of the nearest DGAEM centre.

Now it is time to start making the cages to house the rabbits. Each adult breeding animal must have its own. During the postweaning fattening stage, however, several animals can occupy the same cage. So a group of one male and five females needs about ten cages. The materials and techniques used vary according to what is available. The community's own resources will be utilized to the utmost.

Each cage has a drinker and feeder or feed rack. The nest box is not always used when the floor of the cage is covered with straw litter, but is always recommended. In cold regions it is completely closed; in warmer

FIGURE 53

Example of cross-breeding based on three genetic types at Irapuato

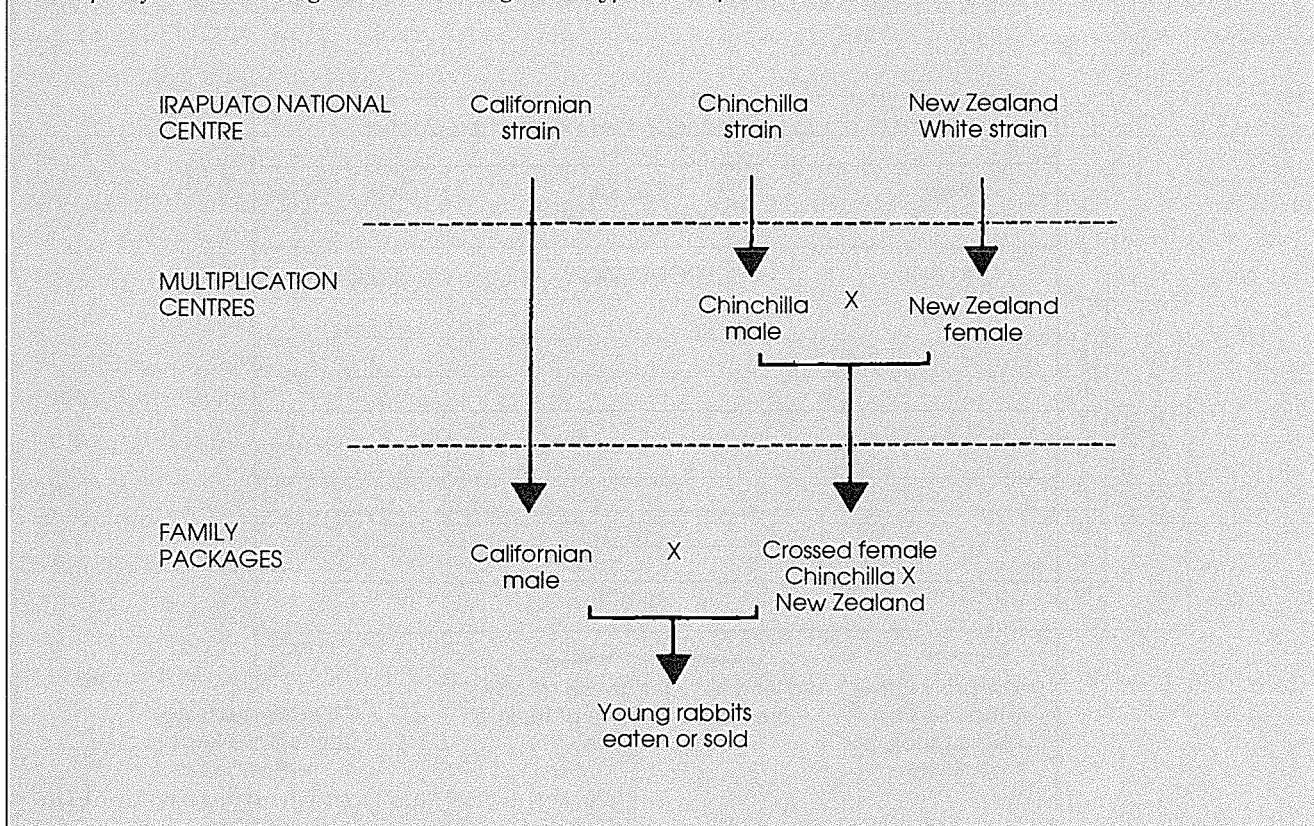

areas it is left half open. In the hottest regions a simple wooden crate will suffice. It is lined with straw or wood shavings. To prevent the urine from collecting at the bottom several small holes are drilled in the floor of the nesting box.

Cages are always placed under some partial shelter from rain, wind, cold, direct sunshine and other extremes. Shelter design and placement must consider the total microclimate, especially the direction of the prevailing winds. Where predators are a threat, adequate protection will be needed to keep them away from the cages.

When the cages are ready the promoter agrees on an arrival date for the animals with the DGAEM centre director. The animals are transported in a closed vehicle which protects them from sun and rain, in well-ventilated cages. They are given water every eight hours.

The first few days are the tricky period of adaptation. The promoter pays careful

attention to the rabbits' behaviour. Three hours after their arrival they are given fresh water. For the following three days they are given only dry feed. After that they may be given green forage.

For their feed, maximum use is made of local forage resources and kitchen waste, or feed wastes of other animals, minimizing the competition with people for food. As part of the integrated rural development programme, families may be encouraged to plant kitchen gardens before the animals arrive. In some areas the promoter gives families kale seeds to plant. The aim is to find the cheapest feed while maintaining the animals at a certain production level. After a few weeks of adaptation, animals over the age of four and a half months are gradually bred, presenting one female to the male each week.

Palpating is a delicate technical operation so it is seldom performed. Nest boxes are systematically set up 25 days after mating.



Ten days later, if the female has not kindled she is mated again. The rate of reproduction should be in keeping with available forage supplies. In some areas the females are not mated during the dry season.

Weaning takes place between 35 and 60 days. The aim is to obtain four litters per female a year, or 24 young, at an average rate of six per litter. The animals are slaughtered when they exceed a live weight of 2 to 2.5 kg. However, the producer does not slaughter an animal until it is needed. Fattening animals constitute a live larder from which the producer takes now and then, according to the family needs.

Regarding health care, almost all treatments are discouraged. A few simple rules of preventive hygiene are usually enough:

- give varied feed daily;
- ensure the structure adequately protects the rabbits from environmental stresses and predators;
- provide clean water;
- prevent the proliferation of flies and insects;
- regularly clean the installations;
- examine the animals every day so as to detect quickly abnormal behaviour;
- quarantine sick animals;
- keep recently acquired animals in quarantine;
- keep visits to a minimum.

The promoter uses commercial products to treat benign infections such as ear mange or injuries to the foot pads. In more serious cases the animals are let out into a closed pen measuring a few square metres and provided with a rough shelter. This is the best and least costly way of looking after them. If this does not produce results the sick animals must be culled. When a serious health problem affects the community as a whole, the promoter calls in a DGAEM expert.

When it is time to slaughter and eat the first rabbits, the promoter's teaching role becomes critical. The families have to learn

to kill a rabbit cleanly, bleed it, cut it up and gut it. There is no better way than to give a demonstration right in the rabbitry. The promoter shows them how to clean the carcass and set the skin out to dry so that it can be used later.

To induce the family – and especially the children – to eat the rabbit, just a little imagination and the slightest persuasion are usually all that is necessary: imagination to prepare the rabbit according to a local recipe; persuasion to get one member of the family to agree to take the first bite. At the community level, a rabbit-tasting session could be arranged when the first young rabbits have reached slaughter age. DGAEM has published several booklets offering Mexican-style rabbit recipes.

There are many ways to use the by-products depending on the community context and the promoter will try to get the community to make the best and fullest use of them. Rabbit skins can provide the raw material for a small handcraft industry. Tanning will be done in a community workshop. DGAEM centres are equipped to teach these techniques. Many articles can be produced from the skins. The tanning workshop in the Irapuato centre, for example, makes bags, children's clothes and bed covers. Other parts of the rabbit can also be used, for example the paws and tails for keyrings.

The promoter ensures in advance that there are marketing outlets for these products, perhaps in one of the many tourist centres dotted about Mexico. Surplus meat can be sold to local restaurants. Earthworms can convert excrement into fertilizer where the climate is suitable, and this can be spread on the family's kitchen garden.

The promoter must carefully follow up the development of the programme in the community. After the various preparatory stages have been completed it is the production stage that convinces the producer of the programme's benefits. The number of kilograms of meat produced per family is

an important standard. This is the point that will attract the interest of other families and nearby communities.

The next phase is home consumption – the number of kilograms of carcass eaten by the family, especially the children, should be the basic standard of evaluation. Income generated by by-products and the sale of any surplus meat is another important item.

In supervising the programme the promoter notes the dates of visits to each family, progress made in the unit and the advice given. The information is summed up on an evaluation form and sent monthly to the DGAEM centre. On it the output of the family packages, the side benefits and also the problems are noted. This feedback is an essential part of the family packages programme, but in practice it is often difficult to obtain.

### THE SITUATION IN 1993

The programme just described has developed since the 1970s and productivity has shot up. Interest in rabbits declined in the early 1980s, output dropped and many problems appeared, primarily feed. Training and development activities were halted and the resources earmarked for the programme severely curtailed. The DGAEM disappeared and the Irapuato Centre staff were slashed by 75 percent. Centres such as Irapuato became state and not federal responsibilities.

The crowning touch in this decade of crisis for rabbit production was the appearance of viral haemorrhagic disease in late 1988. An exceptional control mechanism was soon in place. Vaccination was forbidden. Major information campaigns were broadcast on radio and television. The sources of infection were identified and all animals in contaminated production units culled. A figure of over 120 000 rabbits has been quoted. The rabbit breeders received damages and the units were restocked a few months later. The experts were amazed

at the size of rabbit production in urban areas, particularly Mexico City (Finzi, 1991). This original strategy is thought to have cost US\$22 million (Colin, 1994), but it seems to have worked. The information campaign did have a depressive effect on rabbit meat consumption, however.

This exemplary mobilization is an indication of Mexican interest in rabbits. The 1991 mission of Professor J. Galvez Morros culminated in a decision by Mexico to mount a new rabbit project with two components: to renovate the regional rabbit development centres and to reactivate training and development activities. The plan is to renew four centres: Irapuato with 1 500 does, Ixtacuixtla with 300, Aguascalientes with 200 and Xochimilco with 100. While the buildings can still be used, all equipment needs to be replaced.

The National Rabbit Centre has a triple mission: genetic improvement for supply to other centres; experimentation; and documentation. It is under the authority of the National Confederation of Livestock Producers.

State and private training and development efforts will be pooled. A survey will identify areas where the family packages programme is still functioning. Not enough competent technicians are available for training, and the rabbit development centres will therefore need to go into operation at the earliest possible date. The survey will also pinpoint what training is needed by rabbit breeders. For the development component, each state will run its own programme based on the DGAEM family packages programme. The feeding problem is as acute today as ever.

Colin (1994), in a recent summary of the state of rabbit production in Mexico, estimates a yearly output of 15 000 tonnes, 12 500 of which from family rabbitries. Mexico is a good illustration of the rabbit's great potential adaptability and also of the need for training. It is possible to develop

family-scale rabbit breeding in a country where there is no firm tradition of rabbit meat consumption. Mexico is thus a model for many countries in the south that would like to see sustainable development of rabbit production.

#### **A DEVELOPMENT PROGRAMME USING RABBITS**

A brief review of other rabbit development programmes in the southern countries concludes this chapter.

Benin is of particular interest (Kpodekon, 1988; Kpodekon, 1992; Kpodekon and Coudert, 1993). There is a lively tradition of rabbit husbandry in this West African country, the northern part of which has a tropical climate with a dry season running from November to April and a rainy season from May to October. Southern Benin has a sub-equatorial climate with two alternating dry and rainy seasons. Small family rabbitries averaging four does based on local resources are the usual pattern. Benin has set up a rabbit research and information centre (CECURI) to vitalize the sector. This centre, located on a university campus, has an experimental rabbit production unit. Its twin objectives are to promote expertise through research and development and extend rational rural rabbit production. The promoters of this centre insist on the need for local solutions to feeding, genetic and material problems. As in Mexico, the emphasis is on training for breeders and the need to listen carefully to their questions. This resource centre does need finance to operate, however, a problem requiring a clear political will favouring rabbit production. CECURI made spectacular technical progress between 1988 and 1991: fertility virtually doubled, litter size at birth rose by 30 percent and mortality was cut by a factor of between two and six. There again, the time factor is important: a centre of this type needs several years to reach cruising speed and iron out the main production problems.

One final aspect that deserves emphasis is CECURI's 1992 organization of the First Regional Rabbit Congress, an indication of the need for cooperation between countries in resolving rabbit production development problems in tropical and equatorial Africa.

Unfortunately, as in Mexico, most rabbitries in Benin were decimated in late 1995 by viral haemorrhagic disease. A new rabbit development programme is currently under evaluation.

Lukefahr and Cheeke (1992) summarized their review of various development programmes in southern countries, particularly in Africa. In addition to the aspects of the Mexican programme already mentioned, they come up with a number of original ideas. In their view, the initial demand for rabbit development should come from the breeders themselves. They next suggest setting up a network of leading breeders, representing different villages, to follow programme developments and identify problems more quickly. Training is a major item and to be successful all trainers should also be breeders. They also agree with Kpodekon and Coudert that research and development programmes are crucial in solving local problems and they stress the need for reliable technical information.

#### **Summary**

Analysing a small rural rabbitry depends on a number of interacting factors. Not all operate on the same level: Figure 54 gives an idea of how they interconnect. The reader can either start from the centre and read outwards, or start from the outside and read inwards. The objectives are in the centre. Here the major goal is to produce proteins to feed the breeder's family. A secondary goal is to generate family income through sales and employment.

The first circle around the centre shows factors that directly affect achievement of the objectives. Double arrows show how

several factors interact at the same level. The second circle contains a second series of factors. The plain arrows represent the action of one factor on another. The system considered here is only a subsystem, one component of a global system of rural development and links with the outside are barely indicated in the diagram.

The programme is executed by a national organization. This structure is responsible for developing the work. Its task is to inform, create awareness and provide training and evaluation. Local backup is provided by regional units which do the same job. The regional units do not train the producers directly; they train the technical people who are in touch with the field. This decentralization is essential to the effectiveness of the whole and to avoid the excessive growth of the organization that is technically responsible for the programme. The regional units produce and multiply the breeding animals. They may also act as centres for demonstration and experiment, where the animals' reactions to the production techniques and the agroclimatic conditions they will meet outside the centre can be tested.

This programme is one section of an integrated development programme. According to circumstances it might embody such features as production of other animal species, agronomy, horticulture, or perhaps home economics, hygiene or home renovations. Such integration requires good coordination between the executing agency and the other development agencies: some technical, others more concerned with socio-economic work.

In practice, liaison is through the promoter responsible for keeping the programme going. He will have been given basic training in rabbit production at one of the regional production centres. Preferably, he should have two years' experience in rearing rabbits. His training will also enable him to lead other programmes.

The sphere of action is the village community. To get these programmes off the ground at least ten families have to join. This number makes the agent's work more effective, promotes interest in the community and makes mutual assistance more effective. It also makes it unnecessary to include one male in each batch of five females. The promoter can distribute a number of males among the units and organize their use.

The promoter must be in constant contact with the local branches of each organization involved in the programme. Periodic reports will enable him to evaluate his work. Regional experts can rapidly detect problems that come up and help the promoter solve them. Feedback is essential for the system to run smoothly.

The human factor is a very basic component of this environment. The promoter has a primary role. It is he who arouses interest and enthusiasm, who provides information and who guides the rabbit breeders. He is both instructor and observer; he must not give up easily, but he must also be patient. He is largely responsible for the level of technical ability reached by the farmers.

It is hard to modify agroclimatic factors, so they must be exploited as much as possible. An inventory of regional forage resources often requires the intervention of an agrobotanist. Medicinal plants could be useful, for example. Water resources will be the subject of a separate study.

There is a great deal of interaction at this level. The reproduction rate adopted must be decided on the basis of alternating seasons and thus according to forage resources. Where fodder is abundant the production potential of the species can be fully exploited. During harder times, most of the animals will be eaten by the producer's family. He will keep only the future breeding animals. This extreme pattern is adapted to regions where the dry season lasts less than six months.

FIGURE 54  
Global analysis of a development programme using rabbits

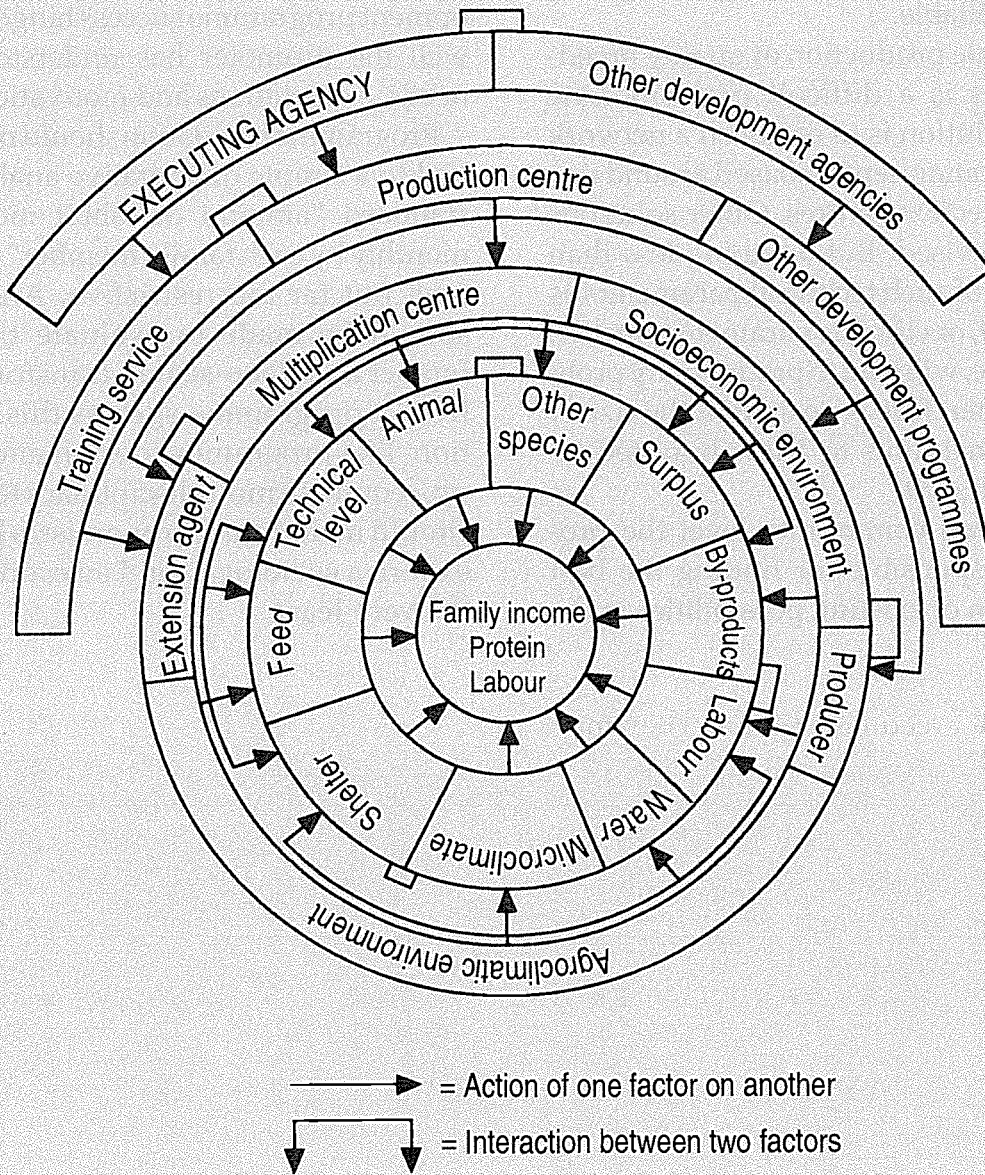

Microclimate, locally available materials and available labour will also determine the type of cage and shelter to be used.

The socio-economic factors depend partly on other development programmes. It is these that determine any sales outlets for eventual meat surpluses or by-products. Where there are enough by-products a small industry can be launched to provide a little work and generate some income for the community.

The animal factor should not be overlooked.

A systematic evaluation of local genetic types will help to breed animals adapted to the local agroclimatic complex. A policy of cross-breeding to reinforce this adaptation to the environment and so upgrade productivity can be tried. Selection should take place in an environment not too different from the area where the producers work. In countries with several clearly defined climatic zones, selection should be done at the regional centres.

Rearing rabbits jointly with other animals such as domestic poultry (chicken, duck, turkey), small ruminants, bees or fish is often the best way to exploit the resources available.

Large-scale production of quality breeding animals is a difficult problem. One effective solution is to establish a network of multiplication centres based around one or more selection centres. Other solutions could be devised. But anything less than full control of such technical parameters as feed quality, or climatic parameters such as temperature, will lead to productivity problems. It is therefore wise to limit the size of these regional units to a few hundred females at the start.

At the rural community level the promoter is responsible for finding the best combination of existing possibilities in the

light of local constraints. There is probably no need to reiterate the importance of the work of this person and the need to reach an understanding with the community. Development programme success hinges on how well the promoter has understood their needs, expectations and motivations.

Programme evaluation should not be limited to a simple quantitative analysis. The standard "amount of rabbit meat eaten monthly by each family member" is important, but far too restrictive. An attempt should be made to evaluate the social impact and deep-seated transformations from a programme such as this. Evaluation, like programme design and follow-up, requires a multidisciplinary team. This should include an agronomist, a livestock expert, a sociologist and an economist, at the very least.

## Bibliography

- Adrian, J., Legrand, G. & Frangne, R.** 1981. Dictionnaire de biochimie alimentaire et de nutrition. Technique et documentation, Paris.
- Afifi, E.A. & Khalil, M.H.** 1992. Cross-breeding experiments of rabbits in Egypt: synthesis of results and overview. *Options méditerranéennes, Seminar Series*, No. 17, p. 35-52.
- Arnold, J.** 1984. Les modèles de pigmentation chez le lapin. *Cuni-Sci.*, 3: 1-12.
- Ayyat, M.S., Habeeb, A.A. & Bassuny, S.M.** 1991. Effects of water salinity on growth performance, carcass traits, and some physiological aspects of growing rabbits in summer season. *Egyptian J. Rabbit Sci.*, 1:21-34.
- Bolet, G., Brun, J.M., Hulot, F. & Theau-Clément, M.** 1990. Variabilité génétique et effet de la sélection dans le croisement de trois souches de lapins – 2. Composantes biologiques de la taille de portée. *Mémoire, 5<sup>es</sup> Journées de la recherche cunicole*, Paris, December 1990. Communication No. 65. ITAVI, Paris.
- Brun, J.M., Bolet, G. & Ouhayoun, J.** 1992. The effects of cross-breeding and selection on productive and reproductive traits in trial experiment between three strains of rabbits. *Fifth World Rabbit Congress*, Vol. A, p. 181-189.
- Cantier, J., Vesinhet, A., Rouvier, R. & Dauzier, L.** 1969. Allométrie de croissance chez le lapin (*Oryctolagus cuniculus*) – I. Principaux organes et tissus. *Ann. Biol. Anim. Biochim. Biophys.*, 9: 5-39.
- Cheeke, P.R., Kinzell, J.H. & Pedersen, W.N.** 1977. Influence of saponins on alfalfa utilization by rats, rabbits and swine. *J. Anim. Sci.*, 46: 476-481.
- Colin, M.** 1993. Une cuniculture peu connue: la cuniculture nord-américaine (Etats-Unis et Canada). *Cuniculture*, 20: 37-45.
- Colin, M.** 1994. La cuniculture nord-américaine – II. Le Mexique. *World Rabbit Sci.*, 2: 7-14.
- Colin, M. & Lebas, F.** 1994. La production du lapin dans le monde. Communication to 6<sup>es</sup> Journées de la recherche cunicole en France, 6 to 7 December 1994.
- Contera, C.** 1991. Systèmes modernes non conventionnels d'élevage du lapin en Espagne. *Conférence Duquesne-Purina*, 28 November 1991, Chartres-de-Bretagne, France.
- Coudert, P.** 1981. Chemoprophylaxe von Dram und Gallengangskokzidiozen beim Kaninchen. *Deutsche veterinärmedizinische Gesellschaft. V4 Tagung: Krankheiten des Pelztiere, Kaninchen und Heimtiere*. Giessen, 1981, p. 106-119.
- Coudert, P.** 1989. Some peculiarities of rabbit coccidiosis. *Fifth International Coccidiosis Conference*, Tours, France. INRA Publ., Paris, No. 49.
- De Lazzer, M.J. & Finzi, A.** 1992. Technical and economical efficiency of an unconventional rabbit breeding. *Fifth World Rabbit Congress*, Vol. A, p. 615-620.
- Di Lella, T. & Zicarelli, L.** 1969. La produzione della carne nel coniglio di razza bianca di Nuova Zelanda – II. Dati di macellazione a diversa età. *Att. Soc. Ital. Sci. Vet.*, 23: 548-552.
- Dickerson, G.E.** 1978. Animal size and efficiency: basic concepts. *Anim. Prod.*, 27: 367-379.

- Eberhart, S.** 1980. The influence of environmental temperatures on meat rabbits of different breeds. *Mémoire II, Congrès mondial de cuniculture*, Barcelona, Spain, April 1980, Vol. I, p. 399-409.
- Elamin, F.M.** 1978. Rabbit husbandry in the Sudan. *Provisional report No. 4, Rabbit husbandry*. Morogoro, Tanzania, December 1978, p. 29-42.
- Estany, J., Camacho, J., Baselga, M. & Blasco, A.** 1992. Selection response of growth rate in rabbits for meat production. *Genet. Sel. Evol.*, 24: 527-538.
- FAO.** 1982. *Les aliments du bétail sous les tropiques. Données sommaires et valeurs nutritives*. Rome.
- Finzi, A.** 1991. La malattia emorragica in Messico. *Riv. Coniglicoltura*, 28 (2): 13-16.
- Finzi, A.** 1992. Rabbit production in developing countries. *Fifth World Rabbit Congress*, Vol. A, p. 86-94.
- Finzi, A. & Amici, A.** 1992. Traditional and alternative rabbit breeding systems for developing countries. *Conférence sur les systèmes de production du lapin de chair*, Valencia, Spain, 14 to 25 September 1992. CIHEAM, Zaragoza, Spain.
- Finzi, A., Tani, A. & Scappini, A.** 1988. The Tunisian non-conventional rabbit breeding systems. *Fourth World Rabbit Congress*, Vol. 1, p. 345-351.
- Finzi, A., Valentini, A. & Fillipi Balestra, G.** 1992. Alimentary, excretory and motorial behaviour in rabbits at different ambient temperatures. *Fifth World Rabbit Congress*, Vol. B, p. 732-738.
- Fischer, W. & Rudolph, W.** 1979. Einfluss des Schlachters auf einige Merkmale der Schlachtkörperqualität von Broilerkaninchen. *Wiss. Z. Wilhelm-Pieck-Univ. Rostock*, 28: 179-182.
- Fort, M. & Martin, S.** 1981. Les bâtiments et le matériel en élevage cunicole. *Bull. Tech. Inf. Minist. Agric.*, 358-359: 195-214.
- Franchet, J.** 1979. La composition des déjections avicoles et cunicoles. In *L'énergie: ressources classiques et énergies nouvelles*. Le courrier avicole, Paris.
- Galvez Moros, J.F.** 1991. Recuperación y mejoramiento de la producción cunicola. Primer informe. Proyecto TCP/MEX 0052 (D). Typed report, 37 pp.
- GELRA.** 1991. *Etude des temps de travaux dans les élevages de référence de la région Rhône-Alpes*. House paper of the Union régionale des groupements de producteurs de lapins de la région Rhône-Alpes (GELRA).
- GELRA.** 1992. *Rentabilité comparée de différents élevages suivis en GTE*. House paper of the Union régionale des groupements de producteurs de lapins de la région Rhône-Alpes (GELRA).
- Gidenne, T.** 1986. Effet d'un apport de banane en complément d'un aliment concentré sur la digestion de lapereaux en engraissement. *Cuni-Sci.*, 3: 1-6.
- Gonzales, R.R., Kluger, K.J. & Hardy, J.D.** 1971. Partitional calorimetry of the New Zealand White rabbit at temperature 5° to 35°C. *J. Appl. Physiol.*, 31: 728-734.
- Gregory, P.W.** 1932. The potential and actual fecundity of some breeds of rabbits. *J. exp. Zool.*, 62: 271-285.
- Hammond, J. & Marshall, F.M.A.** 1925. *Reproduction in the rabbit*. Oliver and Boyd, Edinburgh.
- INRA.** 1989. *L'alimentation des animaux monogastriques: porc, lapin, volailles*. 2nd ed. INRA, Paris, 282 pp.
- King, J.O.L.** 1974. The effects of pelleting rations with or without an antibiotic on the growth rate of rabbits. *Vet. Rec.*, 94: 586-588.
- Koehl, P.F.** 1992. GTE nationale 1991: une lapine produit plus de 45 lapins ou 61 kg de viande par an. *Cuniculture*, 19: 219-225.
- Koehl, P.F.** 1993. GTE nationale 1992: une lapine produit 46 lapins ou 62 kg de viande par an. *Cuniculture*, 20: 247-251.



- Kpodekon, M.** 1988. Le point sur l'élevage du lapin en République populaire du Bénin. Perspectives d'avenir. *Cuni-Sci.*, 4: 15-26.
- Kpodekon, M.** 1992. *Impact d'un centre cunicole de recherche et d'information sur la recherche et le développement de la cuniculture au Bénin.* Communication to the First Regional Congress of Rabbit Breeders, 16 to 20 March 1992. 8 pp.
- Kpodekon, M. & Coudert, P.** 1993. Impact d'un centre cunicole de recherche et d'information sur la recherche et le développement de la cuniculture au Bénin. *World Rabbit Sci.*, 1: 25-30.
- Lebas, F.** 1969. *Où en sont les essais d'alimentation des lapins aux granulés de luzerne déshydratée.* Technical data from the Bureau de la nutrition animale et de l'élevage. Marseille. Doc. IT 436 D.
- Lebas, F.** 1971a. Composition chimique du lait de lapine. Evolution au cours de la traite et en fonction du stage de lactation. *Ann. Zootech.*, 20: 185-191.
- Lebas, F.** 1971b. Quoted by Lebas (1975).
- Lebas, F.** 1972. Effet de la simultanéité de la lactation et de la gestation sur les performances laitières chez la lapine. *Ann. Zootech.*, 21: 129-131.
- Lebas, F.** 1973. Possibilités d'alimentation du lapin en croissance avec des régimes présentés sous forme de farine. *Ann. Zootech.*, 22: 249-251.
- Lebas, F.** 1975. *Le lapin de chair, ses besoins nutritionnels et son alimentation pratique.* Revised and amplified. ITAVI, Paris.
- Lebas, F.** 1977. Valeur du 5<sup>e</sup> quartier en élevage cunicole. *Session Economie ITAVI.* Poitiers, May 1977.
- Lebas, F.** 1981. Unpublished data.
- Lebas, F.** 1989. Besoins nutritionnels des lapins: revue bibliographique et perspectives. *Cuni-Sci.*, 5: 1-28.
- Lebas, F.** 1992. Alimentation pratique des lapins en engraissement (2<sup>e</sup> partie et fin). *Cuniculture*, 19: 83-90.
- Lebas, F. & Colin, M.** 1992. World rabbit production and research: situation in 1992. *Fifth World Rabbit Congress*, Vol. A, p. 29-54.
- Le Ménec, M.** 1982. La difficile maîtrise de l'ambiance des bâtiments d'élevage. *Aviculteur*, 420: 81-96.
- Licois, D.** 1992. *Escherichia coli* entéropathogènes du lapin. Summary. *Ann. Rech. Vét.*, 23: 27-48.
- Lissot, G.** 1974. *L'élevage moderne du lapin: 94 consultations utiles.* Flammarion, Paris.
- Lukefahr, S.D. & Cheeke, P.R.** 1992. Rabbit project development strategies in subsistence farming systems. *World An. Rev.*, 69: 26-35, FAO, Rome.
- Machin, D.H., Butcher, C., Owen, E., Bryant, M. & Owen, J.E.** 1980. The effects of dietary metabolizable energy concentration and physical form of the diet on the performance of growing rabbits. *Mémoire II, Congrès mondial de cuniculture*, Barcelona, Spain, April 1980. Vol. II, p. 65-75.
- Maertens, L., Janssen, W.M.M., Steeland, E., Wolters, D.F., Branje, H.E.B. & Jager, F.** 1990. Tables de composition, de digestibilité et de valeur énergétique des matières premières pour lapins. 5<sup>es</sup> Journées de la recherche cunicole, 12 to 13 December 1990. Communication No. 577. ITAVI, Paris.
- Martin, S.** 1982. En maternité, en engraissement: les moyens d'améliorer la productivité. *Aviculteur* (special issue), 19: 21-24.
- Masoero, G.** 1982. Breeding and cross-breeding to improve growth rate, feed efficiency and carcass characters in rabbit meat production. *Second Congress of Genetics Applied to Livestock Production*, VI, p. 499-509.
- Matheron, G. & Chevalet, C.** 1977. Conduite d'une population témoin de lapins. Evolution à court terme du coefficient de consanguinité selon le schéma d'accouplement. *Ann. Génét. Sél. Anim.*, 9: 1-13.

- Matheron, G. & Dolet, P.** 1986. Performances en milieu tropical: premiers résultats en Guadeloupe. *Cuniculture*, 13: 103-110.
- Matheron, G. & Martial, J.P.** 1981. L'élevage du lapin en ambiance chaude et humide: étude de quelques réponses zootechniques et physiologiques. *Mémoire de fin d'étude de J.P. Martial*. ENSA, Rennes.
- Matheron, G. & Mauléon, P.** 1979. Mise en évidence de l'action conjointe des effets directs maternels et grand-maternels sur la taille de portée. *Bull. Tech. Dép. Génét. Anim.*, INRA, 29-30: 232-263.
- Matheron, G. & Poujardieu, B.** 1984. La génétique du lapin: le point, les perspectives. *Third World Rabbit Congress*, Vol. 1, p. 3-32.
- Matheron, G. & Rouvier, R.** 1977. Optimisation du progrès génétique sur la prolificité chez le lapin. *Ann. Génét. Sél. Anim.*, 9: 393-405.
- Mgheni, M. & Christensen, K.** 1985. Selection experiment on growth and litter size in rabbits – III. Two-way selection response for litter size. *Acta Agric. Scand.*, 35: 287-294.
- Moret, B.** 1980. Comportement d'oestrus chez la lapine. *Cuniculture*, 7: 159-161.
- Morisse, J.P.** 1981. L'influence de l'environnement sur la pathologie respiratoire: les résultats d'une enquête sur le terrain. *Courr. avicole*, 812: 13-16.
- Narayran, A.D., Rawat, S. & Saxena, C.** 1985. Evaluation of response to selection for litter size in rabbits. *Indian J. Anim. Sci.*, 55: 954-957.
- Oloufa, M.M., Bogart, R. & McKenzie, F.** 1951. Effect of environmental temperature and the thyroid gland on fertility in the male rabbit. *Fertil. Steril.*, 2: 223-228.
- Ouhayoun, J.** 1974. Les qualités bouchères du lapin: acquis et perspectives de recherches. *Cuniculture*, 1: 92-100.
- Ouhayoun, J.** 1989. La composition corporelle du lapin. *INRA Prod. Anim.*, 2: 215-226.
- Ouhayoun, J., Demarne, Y., Delmas, D. & Lebas, F.** 1981. Utilisation de pellicules de colza dans l'alimentation du lapin en croissance – II. Effet de la qualité des carcasses. *Ann. Zootech.*, 30: 325-333.
- Paez Campos, A., De Rochambeau, H., Rouvier, R. & Poujardieu, B.** 1980. Le programme mexicain de sélection du lapin: objectifs et premiers résultats. *Mémoire II, Congrès mondial de cuniculture*, Barcelona, Spain, April 1980. Vol. I, p. 263-273.
- Peeters, J.** 1993. Les *Escherichia coli* entéropathogènes (EPEC) du lapin. *Ann. Méd. Vét.*, 137: 361-368.
- Ponce de Léon, R.** 1977. Fuentes genéticas de variaciones y heterosis de los caracteres maternos en cruces simples, triples y de cuatro razas en conejos. Tesis Instituto Sup. Cienc. Agropec. Habana. Inst. Cienc. animal, Havana.
- Poujardieu, B. et al.**, 1993. Pers. comm.
- Proto, V.** 1980. Alimentazione del coniglio da carne. *Coniglicoltura*, 17(7): 17-32.
- Prud'hon, M.** 1975. Le comportement alimentaire du lapin dépend beaucoup de l'abreuvement. *Elevage*, (special issue): une production d'avenir: le lapin, p. 55-59.
- Prud'hon, M., Rouvier, R., Cael, J. & Bel, L.** 1969. Influence de l'intervalle entre la parturition et la saillie sur la fertilité des lapins. *Ann. Zootech.*, 18: 317-330.
- Ramschurn, R.** 1978. New feed resources for rabbits in Mauritius. *Provisional report No. 4, Rabbit husbandry*, Morogoro, Tanzania, December 1978, p. 129-135. IFS, Stockholm.
- Renault, L.** 1975. La pathologie digestive du lapin. *Inf. Tech. Dir. Serv. Vét.*, 51-54: 129-141.
- Reyne, Y. & Salcedo-Miliani, V.H.** 1981. Le lapin peut-il équilibrer seul son ingestion de cellulose? *Cuniculture*, 8: 26-28 and 117-120.

- Reyntens, N., Okerman, F., Keppens, L., De Groote, G., Van Wambeke, F. & Fontaine, G. 1970. Comparaison de la qualité d'abattage des lapins. *Compte rendu d'activité de la station de petit élevage de l'Etat*, Gand, Belgium, p. 168.
- Rideau, P., Coudert, P., Mercier, P. & Hervouet, P. 1992. A comparative study of the virulence of *Pasteurella multocida* from rabbits (*O. cuniculus*). *Fifth World Rabbit Congress*, Vol. C, p. 1389-1400.
- Rochambeau, H. de. 1988. Genetics of the rabbit for wool and meat production (1984-1987). *Fourth World Rabbit Congress*, Vol. 2, p. 1-68.
- Rochambeau, H. de. 1990. Objectifs et méthodes de la gestion génétique des populations cunicoles d'effectif limité. *Options méditerranéennes*, Seminar Series, No. 8, p. 19-27.
- Rochambeau, H. de, Fuente, L.F. de la, Rouvier, R. & Ouhayoun, J. 1989. Sélection sur la vitesse de croissance post sevrage chez le lapin. *Genet. Sel. Evol.*, 21: 527-546.
- Roustan, A., Matheron, G. & Duzert, R. 1980. Influence de l'adoption sur la mesure de la viabilité naissance-sevrage des lapereaux. *Mémoire II, Congrès mondial de cuniculture*, Barcelona, Spain, April 1980, Vol. I, p. 343-354.
- Rouvier, R. 1970. Variabilité génétique du rendement à l'abattage et de la composition anatomique de lapins de trois races. *Ann. Génét. Sél. Anim.*, 2: 325-346.
- Rouvier, R. 1980. Génétique du lapin (*Oryctolagus cuniculus*). *Article II, World Rabbit Congress*, Barcelona, April 1980, Vol. I, p. 159-191.
- Santagreu, M.A. 1992. Estimación de los parámetros genéticos de la taxa de ovulación, supervivencia prenatal y tamaño de camada en conejo. Ph.D. thesis, Univ. of Valencia, Spain.
- Stephen, R. 1952. Seasonal observations on the wild rabbit in West Wales. *Proc. zool. Soc.*, London, 122: 417-474.
- Thébault, R.G., Rougeot, J. & Bonnet, M. 1981. Aménagement et équipement du clapier destiné à l'élevage du lapin Angora. *Cuniculture*, 8: 203-208.
- Varenne, H., Rivé, M. & Veigneau, P. 1963. *Guide de l'élevage du lapin. Rentabilité-Médecine*. Librairie Maloine, Paris.
- Venge, O. 1950. Studies of the maternal influence on the birth weight in rabbits. *Acta Zool.*, 31: 1-148.
- Vrillon, J.L., Donal, R., Poujardieu, B. & Rouvier, R. 1979. Sélection et testage des lapins mâles de croisement terminal. 1973-1977. *Bull. Tech. Dep. Génét. Anim.* (INRA, France), No. 28. 106 pp.
- Yamani, K. 1992. Rabbit production methods (systems). *Conférence sur les systèmes de production du lapin de chair*, Valencia, Spain, 14 to 25 September 1992. CIHEAM, Zaragoza, Spain.
- Zaragoza, P., Arana, A., Rodellar, C. & Morena, B.A. 1990. Blood biochemical polymorphisms in rabbit - I. Genetic variation and distance among populations of rabbits presently bred in Spain. *Options méditerranéennes*, Seminar Series, No. 8, p. 47-52.

## Further reading

- Arvy, L. & Moré, J.** 1975. *Atlas d'histologie du lapin*. Vagner, Paris. 310 pp.
- Barone, R., Pavaux, C., Blin, P.C. & CuQ, P.** 1973. *Atlas d'anatomie du lapin*. Masson et Cie, Paris.
- Boussite, D.** 1989. *Reproduction et insémination artificielle en cuniculture*. AFC, Lempdes, France. 234 pp.
- Castle, W.E.** 1930. *The genetics of domestic rabbits*. Harvard University Press, Cambridge, Mass., USA.
- Ferenc, V.** 1990. *Hazinyul-egésztan*. Mezőgazdasági Kiado, Budapest, Hungary.
- Kotsche, W. & Gottschalk, C.** 1977. *Krankheiten der Kaninchen und Hasen*. Veb Gustav Fischer Verlag, Jena, Germany.
- Lebas, F., Henaff, R. & Marionnet, D.** 1991. *La production du lapin (3<sup>e</sup> éd.)*. AFC et TEC & DOC., 206 pp. Address: AFC, BP 50, 63370 Lempdes, France.
- Lebas, F. & Matheron, G.** 1982. Livestock production in Europe: perspectives and prospects – VIII. Rabbits. *Livest. Prod. Sci.*, 235-250.
- Ministère de la coopération (France).** 1974. *Mémento de l'agronome*. Techniques rurales en Afrique. Eyrolles, Paris.
- National Research Council (USA).** 1977. *Nutrient requirements of rabbits*. 2nd rev. ed. National Academy of Science, Washington, DC.
- Okerman, L.** 1988. *Diseases of domestic rabbits*. Trans. by R. Sundahl. Blackwell Sci. Pub. Oxford, UK. 120 pp.
- Rochambeau, H. de, Arnold, J. & Martinez, C.** 1981. Historique des principales races de lapin. *Les cahiers du conservatoire*, 1: 3-24. Address: 34, rue de Lille, 75007 Paris.
- Sprehn, C.** 1968. *Kaninchenkrankheiten*. Oertel & Sporer, Reutlingen, Germany.
- Weisbroth, S.H., Flatt, R.E. & Kraus, A.L.** 1974. *The biology of the laboratory rabbit*. Academic Press, New York, NY, USA.

---

## Specialized reviews and periodicals

*Boletín de cunicultura*, the professional rabbit breeder's magazine (six issues per year, average 300 pages). Subscribe to: Calle Nou 14, 08785 Valbona d'Anoia, Spain.

*Cuniculture*, the magazine for rabbit breeders (six issues per year, average 350 pages, plus a list of suppliers). Subscribe to: AFC Cuniculture, BP 50, 63370 Lempdes, France.

*L'éleveur de lapins* (five issues per year, average 270 pages). Subscribe to: 35 rue Carnot, BP 1115, F-35014, Rennes Cedex, France.

*Rivista di conigliicoltura* (12 issues per year, average 500 pages). Subscribe to: Via Emilia Levante 31, 40139 Bologna, Italy.

*World Rabbit Science*, Journal of the World Rabbit Science Association (four issues per year, average 200 pages). Subscribe to: AFC, BP 50, 63370 Lempdes, France.









Any comments on this manual would be most welcome and should be addressed to:

**R.D. Branckaert**  
Animal Production Service (AGAP)  
FAO  
Viale delle Terme di Caracalla  
00100 Rome, Italy  
Fax (396)50914149  
E-mail: [Rene.Branckaert@fao.org](mailto:Rene.Branckaert@fao.org)

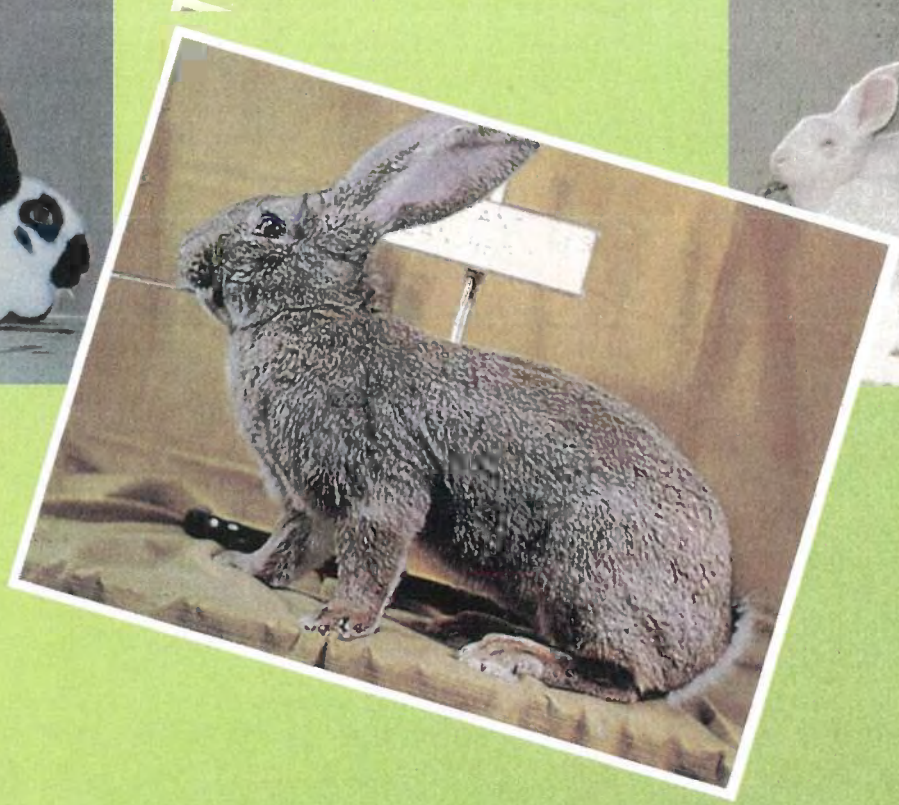
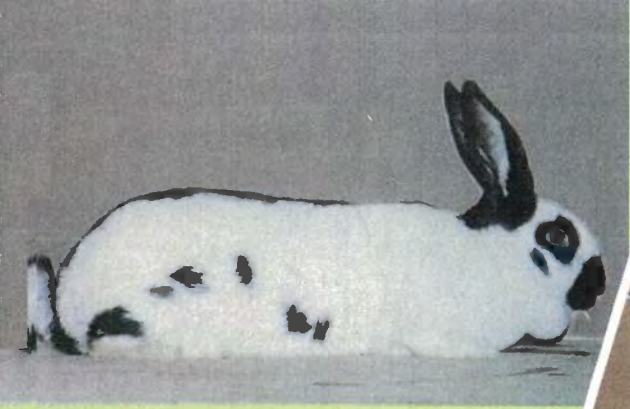

ISBN 92-5-103441-9 ISSN 1010-9021



9 789251 034415

P-27

T1690E/1/11.97/1500