

DEVELOPMENT
TECHNOLOGY
UNIT

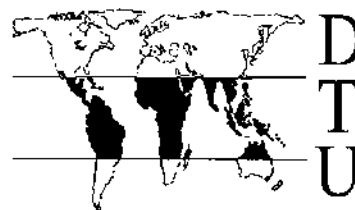

Working Paper No. 41

Algebraic Modelling of the Behaviour of
Hydraulic Ram-Pumps

1994

T.H. Thomas

Development Technology Unit
Department of Engineering, University of Warwick
Coventry CV4 7AL UK
Tel: +44 (0) 1203 523122 Fax: (0) 1203 418922
email: dtu@eng.warwick.ac.uk

Working Paper No. 41

**Algebraic Modelling of the Behaviour of
Hydraulic Ram-Pumps**

by Dr. T.H. Thomas

January 1994

Abstract:

The mathematical analysis of hydraulic ram-pumps began soon after their invention in the late 18th century. However simple models of adequate accuracy for use by system designers, pump manufacturers, installers and operators are still not available. This paper describes algebraic models of varying complexity for use by system and pump designers and by those involved in training installers and users. It argues that a pump plus drivepipe, rather than pump alone is the natural unit for modelling and for characterising performance in applications literature. Behaviour is shown to depend primarily upon three parameters. The first is λ , the ratio of peak drive flow (which depends upon tuning) to the pump's maximum flow with its impulse valve locked open. The second is μ , the ratio of peak drive flow to the 'Joukowski' flow just sufficient to achieve the system delivery head. The third is R , the ratio of delivery head to drive head. The analysis shows some of the trade-offs entailed in tuning, indicates the optimum choice of drivepipe and explains certain forms of malfunction observable in the field. Several 'rules of thumb' are derived. The paper also indicates areas where the greater precision of computer simulation over algebraic modelling is desirable.

CONTENTS

1. Introduction
2. Representing System Performance
3. Models
 - 3.1 Algebraic and Simulation Models Compared
 - 3.2 Simple Models
 - 3.3 Acceleration Phase Models
 - 3.4 Delivery Phase Model
 - 3.5 Recoil Phase Model
 - 3.6 Combining Acceleration, Delivery and Recoil Phase Models
4. The Application of Algebraic Models
 - 4.1 Explaining Phenomena and Improving Pump Design
 - 4.2 Calculating Pump Characteristics
 - 4.3 System Design
 - 4.4 Tuning
5. Conclusion
6. Bibliography

1. INTRODUCTION

This paper describes a number of analytic models, of varying degrees of complexity, for representing hydraulic ram pumps. It examines how such models can be used to optimise tuning, explain anomalous behaviour, aid system design and help in the design of better pumps.

The hydraulic ram pump, a water-powered water-lifting device, is of some antiquity, having been developed by Whitehurst, Montgolfier and others during the eighteenth century. Although its heyday was the late 19th century, there are over twenty manufacturers worldwide still producing machines. The ram pump performs the same role as a low-head high-flow turbine driving a high-head low-flow pump; it is however much simpler than a turbine-pump set as it contains only two moving parts, each a type of valve. The ram pump is mainly used to lift drinking water from small streams in locations where electricity is not available and engine-driven pumps would be costly to operate. The ram pump operates continuously but usually at a low power level (typically 50 to 200 watts), higher-powered pumping being more easily achieved by other means.

There is currently a revival of interest in ram pumps in developing countries and (due to changing tariff structures following privatisation of water supplies) in some industrialised countries too. Renewable energy devices in general are experiencing a come-back usually accompanied by design improvements resulting from new materials or new understanding. Ram pumps, notwithstanding their simple construction, have also undergone some design changes affecting their cost and performance. More important to their wider use have been organisational changes (reducing the communication difficulties between manufacturers, installers and potential users). In developing countries population growth is causing expansion of rural settlements located higher than spring lines and intensification of agriculture through irrigation. Both of these increase the demand for water-powered pumping. The revival of interest has been reflected in several new publications (SKAT, Jeffery 1992, Knol 1992) and some transfer of manufacture to S. America and Africa from other continents.

The modelling of ram pump behaviour also has a considerable history (e.g. Eytelwein 1805, Lorenz 1910, O'Brien & Gosling 1933, Krol 1951, Rennie & Bunt 1981, Glover & Boldy 1990), although there is little evidence of such improvements in understanding affecting pump design or installation practice in the past. Two fairly recent developments have facilitated the devising of better models - improvements in instrumentation have made it easier to observe the complex movement of shock waves in actual systems, and the dramatic drop in computation costs have permitted the use of simulation models using short time steps (e.g. 0.1 millisecond).

This paper arises from the work of the Development Technology Unit at Warwick University over nearly ten years on the identification of social and technical constraints to ram pump use, on the development of low-cost pumps for local manufacture in areas of use and on the transfer of system-installation skills into ten developing countries. Out of that work the need for, and the limitations of, modelling have become clearer.

2. REPRESENTING SYSTEM PERFORMANCE

The key components of a ram-pump system are shown in Figure 1. All of these have properties that affect system performance. There are some complex interactions between these components, so that little meaning can be attached to the "performance" of the pump in isolation. When analysing the operation of a more conventional motorised pump it is possible to characterise the pump and the rest of the hydraulic circuit separately and to then combine these characterisations. The behaviour of a ram-pump is so strongly influenced by the nature of its drive pipe that this sort of analytic separation of system parts is not helpful.

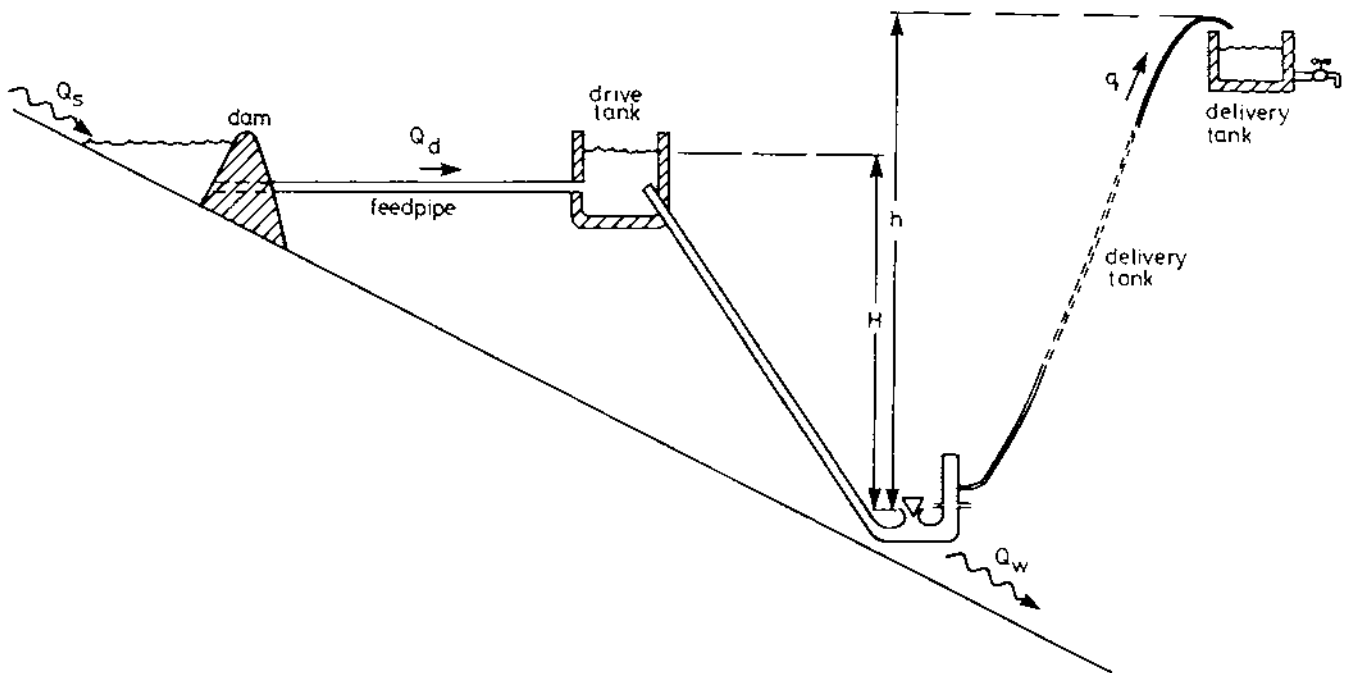

Fig. 1 Components of a ram-pump system

The components of the system have the following general characteristics that influence overall performance.

Feed pipe .. this has a *head loss* (dependent upon its length, diameter, roughness and the mean flow Q_d) which can be readily calculated independently of other system components.

Drive tank .. this is usually of sufficiently large surface area that it has negligible effect on system output and once sized can be left out of any further analysis.

Drive pipe ... this has a *drop* (H) that enters into even the crudest of performance equations, a *slope* (S) that primarily determines the water acceleration during the acceleration phase of pumping, an overall *friction factor* (relating friction head loss to instantaneous water flowrate) and an *area* (A) that relates velocity to flowrate.

Pump this has a *tuning control* that determines the driveflow Q_w at the onset of impulse valve closure, an *impulse valve* whose inertia and fluid drag determines speed of closure once initiated and whose aperture when open determines friction and kinetic energy losses during the acceleration phase, a *delivery valve* whose friction when open and whose inertia when opening and closing help determine pumping efficiency and finally a *flow-smoothing device* (e.g. pressure vessel) which if adequately sized has little effect on system performance.

Delivery this comprises a *delivery pipe* carrying a steady flow (q) whose friction head loss is readily and separately calculable using standard formulae, and a *storage tank* which once sized (e.g. for 12 hours storage) has little effect on mean system performance. The *delivery height* (h) of course determines the outlet pressure at the pump.

When we come to characterise the performance of a system having a given site, pump, drive pipe etc. we normally treat the following as output (dependent) variables:

- (i) delivery flow q
- (ii) mean driveflow Q_d , taken as an average over many cycles

- (iii) beatrate/(cadence) b , pump cycles per second
- (iv) efficiency η , of the pump alone (not an easily defined entity), of the pump plus drive pipe or of the whole system. Efficiency is treated as a known constant (independent variable) in crude models and as a dependent variable in more elaborate models.

The normally determinable independent variables are

- (i) delivery head h , or a higher head h' that includes friction head loss in the delivery pipe
- (ii) drive head H , usually measured from the drive tank and hence already allowing for feedpipe friction head loss
- (iii) drive pipe effective slope S , defined as drive head H divided by drive pipe length L (S has a somewhat more direct influence on performance than L)
- (iv) pump setting Q_{cc} , the flow at which the impulse valve has been tuned to commence closing; this in combination with other variables determines the peak driveflow Q_p occurring during each cycle (a key variable in most analytic models)
- (v) drive pipe area A
- (vi) drive pipe type, and hence firstly its friction coefficient and secondly its wall stiffness that determines the velocity of sound in the water within it
- (vii) pump type, and hence its internal frictions, exhaust velocity for a given driveflow and impulse valve-closure speed.

We have thus a plethora of independent variables whose number is tolerable for entry to a computerised model but is intolerably high if we intend to prepare graphs or tables to be used by a system designer in the field. (Indeed for a designer even the heads H and h are iterative variables since system design includes selecting between alternative water sources and pumphouse sites).

The list of variables above does not include feed pipe or delivery pipe characteristics and for the rest of the paper these will be assumed to be reflected in the values used for drive head H and effective delivery head h' . In practice these pipes will be sized, taking into account their probably large contribution to system cost, to give hydraulic 'efficiencies' of around 95% or even 90% for each: thus H might only be 90% of the drop from source to pumphouse and $h' = h/0.90$. In all our models we will be representing only that part of the system between the entry to the drive pipe and the entry to the delivery pipe.

Of the seven independent variables listed earlier, we might combine the last three for purposes of display output characteristics, producing graphs or tables for a particular combination of pump and drive pipe type (e.g. pump XYZ when used with a 110 mm OD, 10 bar, PVC drive pipe). This leaves for independent variables, two more than can be handled by a single readily readable graph or table. It is useful therefore to identify the degree of influence of these input variables upon the main output variables. Table 1 shows such an influence chart. The entries in the chart are based on experienced estimates of (the modulus of) sensitivity $|E|$

$$\text{where } |E_{yx}| = \frac{|\partial y / \partial x|}{y/x}$$

with y being regarded as the dependent variable. To emphasise the sensitivities, delivery head h' and head ratio $R = h'/H$ are used rather than h' and H .

Sensitivities $|E_{yx}|$ of each output variable to each input variable (acting alone) are allocated into four categories:

H = high sensitivity	$ E > 0.8$	over most of both variables' ranges
M = medium sensitivity	$0.3 < E < 0.8$	" " " "
L = low sensitivity	$0.1 < E < 0.3$	" " " "
VL = very low sensitivity	$ E < 0.1$	" " " "

Table 1: Influence of Independent Variables on Performance

Input variable (x)		Output Variable (y)			
		Delivery flow q	Driveflow Q_d	Beatrate b	Efficiency η
Pump setting Q_{cc}		H	H	H	M
Head ratio R		H	VL	L	L
Delivery head h'		M	L	VL	M
Drivepipe slope S		VL	L	H	VL

Of these output variables, beatrate b is of no fundamental importance but may be used as a tuning indicator by operators. Mean driveflow Q_d may be constrained by the available source flow Q_s and hence should be known. Delivery flow is of primary interest to the system designer and knowledge of efficiency is useful when choosing between models of pumps. Of the independent variables, pump setting Q_{cc} and head ratio R are the main determinants of behaviour, with delivery head h' having a strong influence near the top of its range. Figure 2 illustrates the form of the relationship between inputs Q_{cc} and R and the outputs q and Q_d .

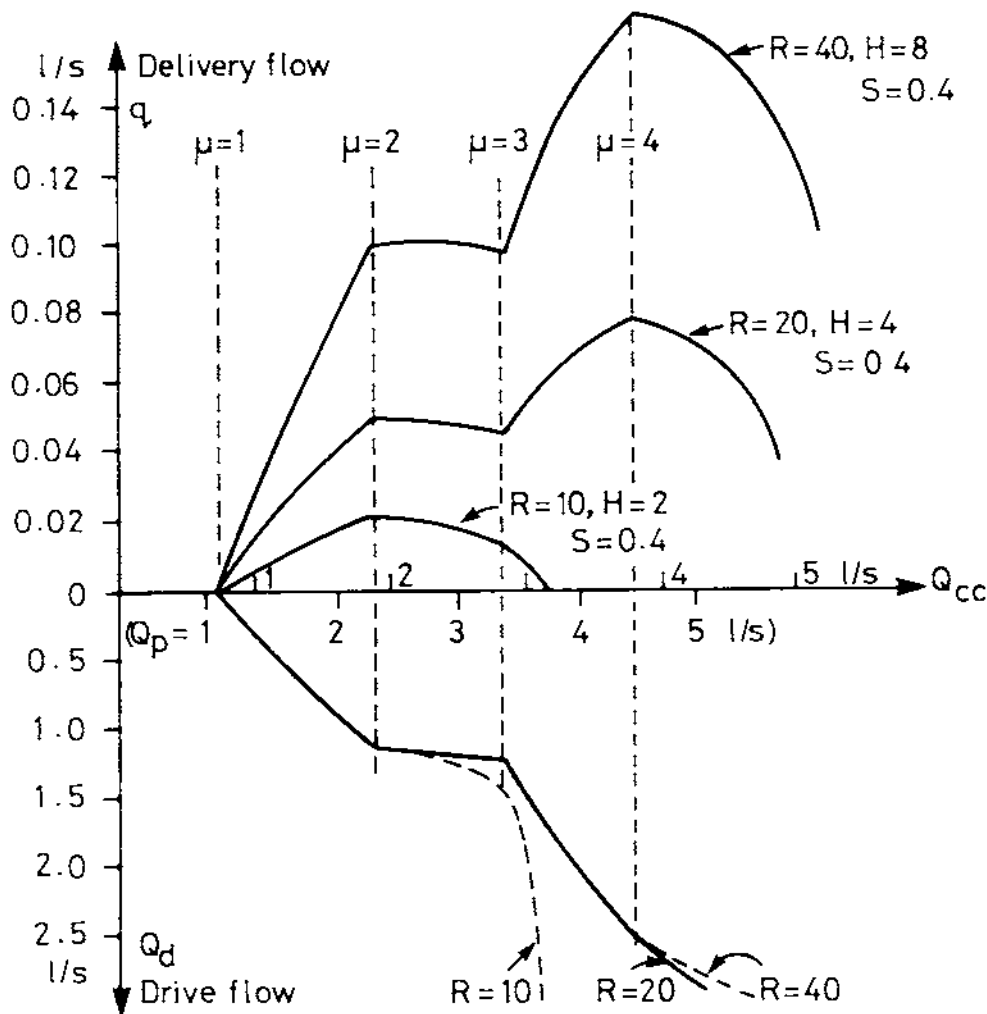

Fig. 2 Characteristic for pump type M8 with 50 mm drive pipe when tuning (Q_{cc}) is varied (delivery head of $h' = 80\text{m}$, drive pipe slope $S = 0.4$, drive head $H = 2, 4$ or 8 m)

3. MODELS

3.1 Algebraic and Simulation Models Compared

Algebraic models, invariable entailing the use of approximations to keep them manageable, are suited to application by 'hand' or by small computer to a range of activities - education, system design, pump selection and pump design. Because it is difficult to solve some of the equations, such models are often employed iteratively to indicate the performance, for example of a guessed-at system design, and how it might be improved by a change in parameters.

Users of ram-pumps are not, generally specialist engineers. Some installers have little education and cannot understand any algebraic notation. A major use of models therefore is to prepare design information even at the level of "rules of thumb". In fact three levels of model complexity can usefully be distinguished. Simple models are those operable by (some) water technicians. Standard models are usable by machine or system design engineers, by manufacturers to prepare charts and tables and for training demonstrations. Research models are primarily for pump designers. The Third World bias in ram-pump usage makes it particularly difficult to communicate and support models in the form of computer software.

Time-step (or-event-step) simulation models, usually based on the method of characteristics to represent transient flows in the drive pipe, have been developed for ram pumps (Glover). They are powerful but so costly of computing power that they are primarily useful for aiding pump design or explaining system phenomena rather than calculating routine performance graphs. Like all numerical techniques, these simulations deal with the particular - the influence of a particular variable can only be explored by repeated simulation 'runs' in which different values of that variable are used. With small computers, even with 486 processors, time-step simulations of ram-pump systems run at only a small fraction (e.g. 1%) of real time.

This paper restricts itself to 'simple' and 'standard' algebraic models and their use.

3.2 Simple Models

The simplest model of a ram-pump employs the concept of power balance and efficiency to give:

output power = input power \times efficiency

$$\rho g q h' = \rho g Q_d H \times \eta$$

$$q = \eta Q_d / R \quad \text{where head-ratio } R = h/H \quad [1]$$

The efficiency η so defined varies widely with operating conditions, falling to zero if Q_d is too small or R is too large. Manufacturers tables are however usually based on an assumed *constant* efficiency and users are often advised of constraints outside which they should not stray. Equation [1] probably represents the highest level of mathematical complexity one can expect any field worker or water technician to handle.

A model that can be employed in the teaching of field staff is the 'lumped-system' one whereby the pump cycle is broken into two phases. During an acceleration phase the water in the drive pipe accelerates under the drive head H , that is at rate $a = gH/L = gS$. During the deceleration phase the water decelerates under a reverse head of $h' - H$ giving $a = g(H - h')/L = gS(1 - R)$. This model neglects friction or the kinetic energy in the exhaust water; it also treats the water in the drive pipe as incompressible and hence fails to predict the negative pressures during end-of-cycle rebound that are

important for pump operation. However this lumped-system model has several simple virtues that are not seriously affected by the rather drastic approximations inherent in it.

The velocity profile that the model generates is shown in Figure 3 superimposed upon a more realistic one.

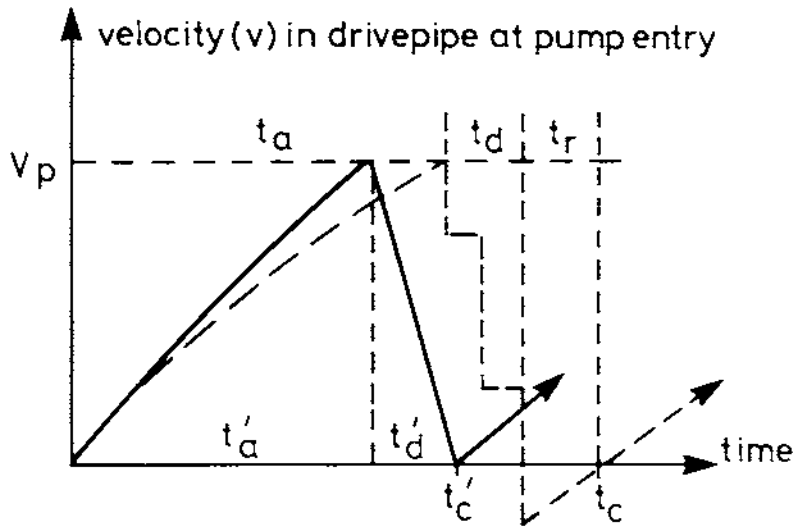

Fig. 3 Velocity profile predicted by frictionless lumped-system model (Actual profile shown dashed)

The approximations result in predictions of acceleration phase time t_a a little shorter than reality t'_a , a delivery phase of about the right duration ($t_d = t'_d$) and no rebound time ($t_r = 0$). However in normal operation the drivepipe friction causing t_a to exceed t'_a will be fairly small and the rebound phase may be short. Within about 10% accuracy this model correctly indicates the following.

- (i) The cycle time is dominated by the acceleration phase.
- (ii) For high head ratios ($R > 10$ so $t_c = t_a$),

$$\begin{aligned} \text{peak velocity } v_p &= g S t_c \quad (t_c \text{ is cycle time}) & [2] \\ \text{mean drive flowrate } Q_d &= 0.5 A v_p \end{aligned}$$

- (iii) The shape of the driveflow-versus-time plot, Fig. 4 will be roughly a sawtooth (since $Q = A v$) for which the friction correction factor is

$$\text{CF} \equiv \frac{\text{average head loss with sawtooth flow pattern}}{\text{head loss at same } Q_d \text{ but flowing steadily}} = 2 \quad [3]$$

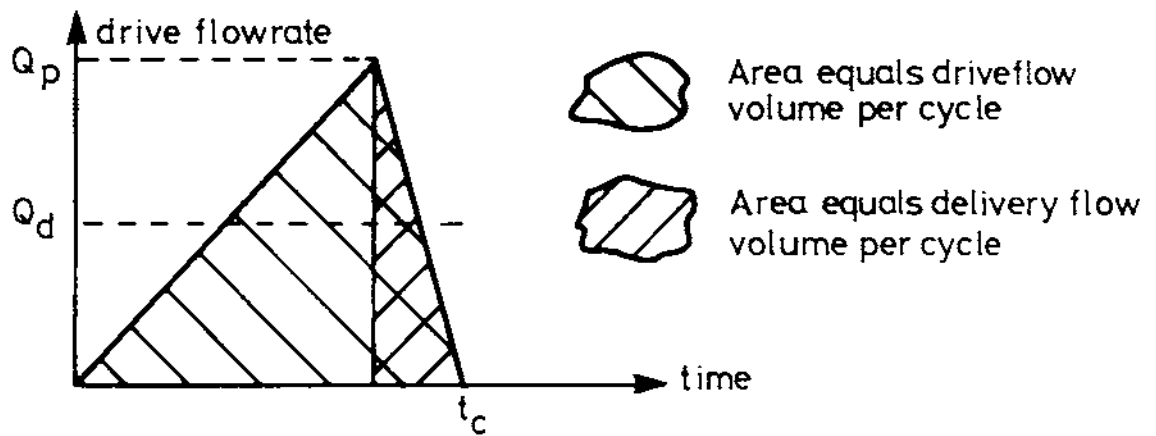

Fig. 4 Flowrate versus time predicted by frictionless lumped-system model

Thus drive pipe and exhaust kinetic energy losses can be first calculated assuming Q_d flows constantly and then doubled to allow for the waveform. Derived from this and the assumption that neither pipe friction loss nor waterflow kinetic energy should exceed, say, 10% of input energy gives two rules-of-thumb:

ROT.1 "Drive pipe size should be such that its headloss when carrying steady flow Q_d does not exceed 5% of H ".

ROT.2 "The maximum height to which exhaust water sprays above the impulse valve (just before the latter closes) should not exceed 20% of H " (Height assumed proportional to KE , maximum flow rate Q_p assumed to be twice Q_d).

For any specific tuning, the pump manufacturer could describe the pump's friction and kinetic losses by specifying an equivalent length of (standard diameter) drive pipe L_{pe} . Drivepipe plus pump can be replaced by a simple but longer drivepipe (length $L + L_{pe}$), enabling a designer with access to pipe friction tables to apply:

ROT.3 "The headloss through drivepipe and pump together when carrying steady flow Q_d should not exceed 10% of H ".

3.3 Acceleration Phase Models

The acceleration phase model above neglects various important effects, most noticeably factors which retard the gravitational acceleration. More accurate models were developed long ago but are not usually of a form convenient for a system designer.

The acceleration phase can be deemed to start when the water in the drive pipe starts to move downwards again (following its upwards recoil movement at the end of the previous cycle). Although shock waves may still be travelling up and down the water in the drive pipe, their amplitude should be small enough that the whole water column can be treated as having a single, initially zero, velocity.

It can readily be shown that the instantaneous acceleration of the drive pipe water satisfies

$$\frac{dv}{dt} = g S (1 - kv^2) \quad [4]$$

So that acceleration terminates when

$$v = v_{\infty} = k^{-\frac{1}{2}} \quad [5]$$

The retardation factor k reflects the headloss at drive pipe entry, plus that due to drive pipe friction, that caused by friction within the pump and the velocity head 'thrown away' in the waste water. The head loss due to all these factors can be expressed as a multiple of the velocity head in the pipe

$$H_{\text{loss}} = C \times \frac{v^2}{2g} \quad (\text{where } C = 2gH \times k) \quad [6]$$

$$\text{and } C = C_1 + C_2 + C_3 + C_4 \quad [7]$$

where C_1 is pipe inlet loss coefficient, typically 0.2 to 0.5

C_2 is pipe friction coefficient fL/D and f is typically 0.02

C_3 is pump loss coefficient, typically 1.5 but may be much higher

$C_4 = A^2/A_e^2$ where A is the pipe's cross-sectional area and A_e is the effective area of the discharge aperture of the impulse valve.

The first of these coefficients is usually negligible compared to the others, especially if the drive pipe inlet has a bell mouth. For practical purposes:

$$k = k_d + k_p \quad [8]$$

where k_d (representing the drive pipe) equals $C_2/2gH$ and k_p (representing the pump) equals $(C_3 + C_4)/2gH$.

For the pump designer the minimisation of k_p is an objective, especially by maximising A_e to keep C_4 small and having large internal channels to keep C_3 small. k_p varies with pump tuning. For the system designer maximum economy comes from matching drive pipe to pump so that k_d is neither much greater than k_p nor much less. This fixing a pump (with impulse valve jammed open) onto a previously open-ended drive pipe should not reduce the flow through it by a factor more than 1.7 (implying $k_p < 2 k_d$) or less than 1.22 (implying $k_p > k_d/2$). A rule-of-thumb that arises out of this analysis is:

ROT.4 "The area of the impulse valve's exhaust aperture should not be much smaller than the drive pipe's cross-sectional area".

Returning to equations [4] and [5], solving and relating all velocities to the maximum velocity attainable, gives

$$\text{normalised velocity, } \lambda = v/v_{\infty} = \frac{e^{2\tau} - 1}{e^{2\tau} + 1} \quad [9]$$

where normalised time, $\tau = t/t_o$ (and where $\lambda = \lambda_p$, $\tau = \tau_m = t_a/t_o$)

and reference time, $t_o = v_{\infty}/gS$ (time to reach the velocity v_{∞} were there no retarding influences)

The relationship is plotted in Figure 5 where the normalisation is also illustrated.

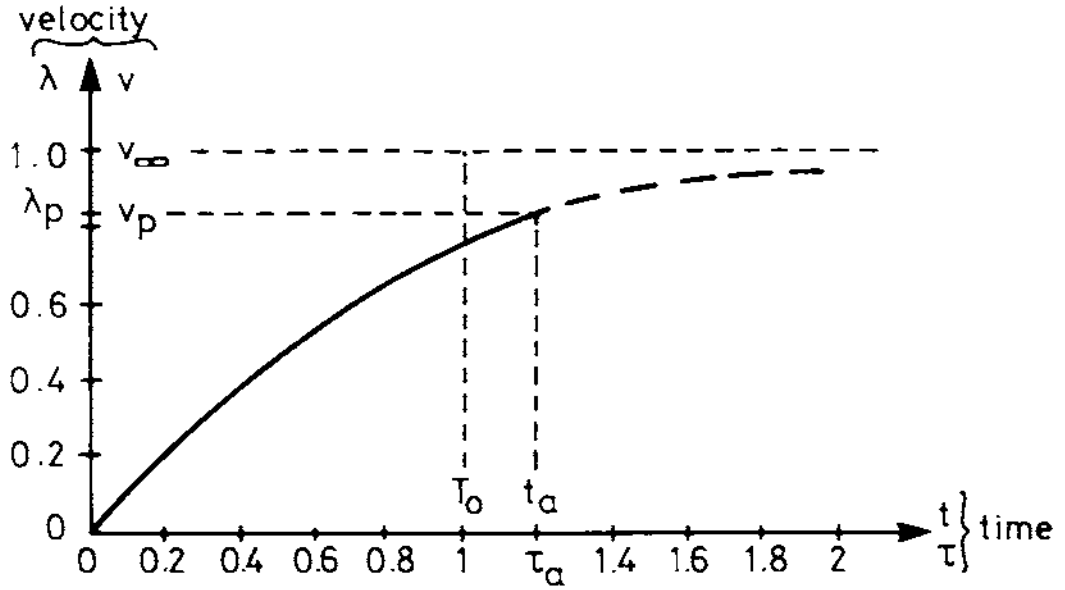

Fig. 5 Variation of water velocity during the acceleration phase
 ($\lambda = v/v_{\infty}$ and $\tau = t/T_o$ are normalised values)

This model is helpful discussing pump tuning. Tuning indirectly determines the peak velocity v_p at which acceleration terminates. As the purpose of the acceleration phase is to convert potential energy (height) into kinetic energy, we are interested in efficiency and power (rate of forming KE). Both of these are functions of v_p .

Figure 6 shows the efficiency and the normalised power of the acceleration phase as a whole, as functions of the normalised peak velocity at impulse valve closure ($\lambda_p = v_p/v_{\infty} = Q_p/Q_{\infty}$). The relevant algebraic expressions are:

$$\eta_a = -\lambda_p^2 / \ln(1-\lambda_p^2)$$

$$P_a = \rho AL \cdot \frac{gH}{2} \cdot v_{\infty} \times \frac{\lambda_p^2}{\tau_{\infty}} \quad [10]$$

$$t_a = \tau_a t_o = \frac{1}{2} \ln \left(\frac{1+\lambda_p}{1-\lambda_p} \right) v_{\infty} / gS$$

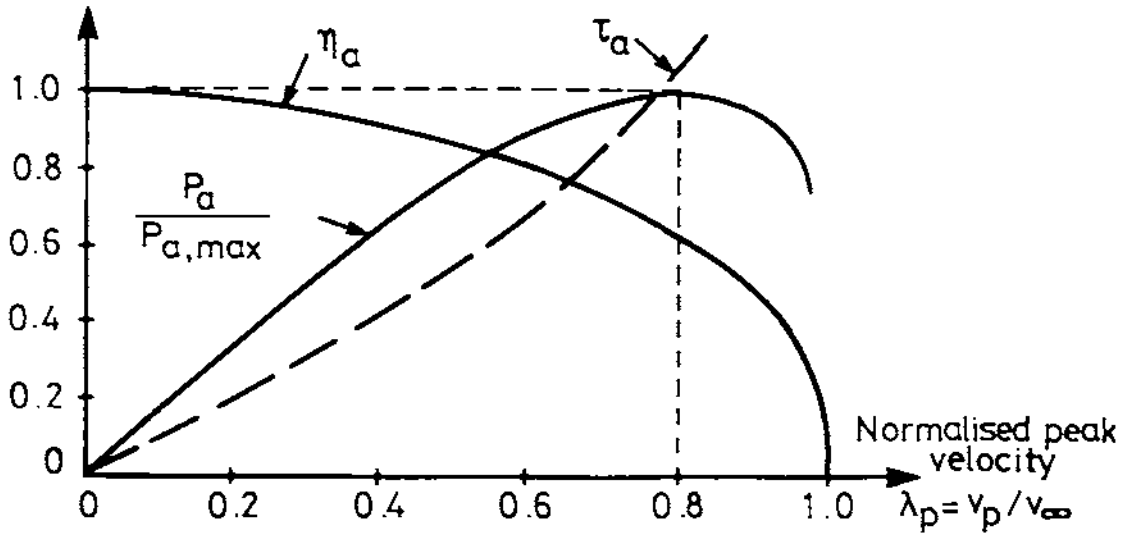

Fig. 6 Efficiency and power of the acceleration phase
(v_p is velocity at the end of the phase)

During the acceleration period the average velocity is about half the peak (final) velocity. The average and peak flows are similarly related. The acceleration time is close to $v_p/g S$ being actually:

$$t_a = \frac{v_p}{g S} \cdot \frac{\ln\{(1+\lambda_p)/(1-\lambda_p)\}}{2\lambda_p}$$

and the average velocity during acceleration is given by:

$$\frac{\bar{v}_a}{v_p} = \frac{\bar{Q}_a}{Q_p} = \frac{-\ln(1-\lambda_p^2)}{\lambda_p \ln\{(1+\lambda_p)/(1-\lambda_p)\}}$$

Which tabulates as Table 2

Table 2 Mean acceleration flowrate and acceleration time

λ_p	0	0.1	0.2	0.3	0.4	0.5	0.6	0.7	0.8	0.9	(1.0)
$t_a \div g S/v_p$	1.00	1.00	1.01	1.03	1.06	1.10	1.16	1.24	1.37	1.64	(∞)
$\bar{Q}_a / \frac{1}{2}Q_p$	1.00	1.00	1.01	1.02	1.03	1.05	1.07	1.11	1.16	1.25	(2)
η_a	1.00	0.99	0.98	0.95	0.92	0.87	0.81	0.72	0.62	0.49	(0)

From Figure 6 it is obvious there is no purpose in setting λ higher than 0.8 (i.e. peak drivepipe flow equal to 80% of its maximum possible value). Maximum acceleration power occurs at $\lambda = 0.8$ but the efficiency is then low, $\eta = 63\%$. A much lower flow setting is usually preferable, for example $\lambda = 0.47$ will give 75% of maximum power but raise acceleration efficiency to $\eta = 90\%$. Although there are other factors to be discussed in the next section, Figure 6 illustrates the main trade-off between throughput and efficiency involved in tuning. It can also be used in reverse, in the sense that a designer could work back from a desired mean drive flow Q_d and desired acceleration efficiency to estimate the necessary limiting flow ($Q_\infty = A v_\infty$). From that the value of k in equations [4] to [8] is implied for which a suitable pipe and pump can be selected.

Refinements to this model are possible but do not greatly affect Figure 6. For example the previous recoil phase may have left the lower part of the drive pipe empty at the instant that forward motion of water recommences. This will have the effect of reducing the coefficients in equation [7] (e.g. $C_3 = 0$, $C_4 = 1$) until the water-air interface has passed back through the pump again. With normal recoils this lessening of friction at low velocities has negligible effect.

Representing, in fine detail, the flow behaviour during the last milliseconds of impulse valve closure is beyond the practical scope of algebraic models and is an area where simulation models give better insight. There is little evidence that the assumption of instantaneous valve closure will seriously falsify conclusions drawn from the acceleration model described above.

The acceleration phase model developed above does not readily yield a rule of thumb for pump tuning other than

ROT.5 "Pumps tuned to have very long cycle times (e.g. t_c over 3 seconds) will be very inefficient".

This rule is illustrated by Fig. 7: T_0 is typically 0.5 to 1.5 seconds and t_a is typically 90% of measured cycle time t_c .

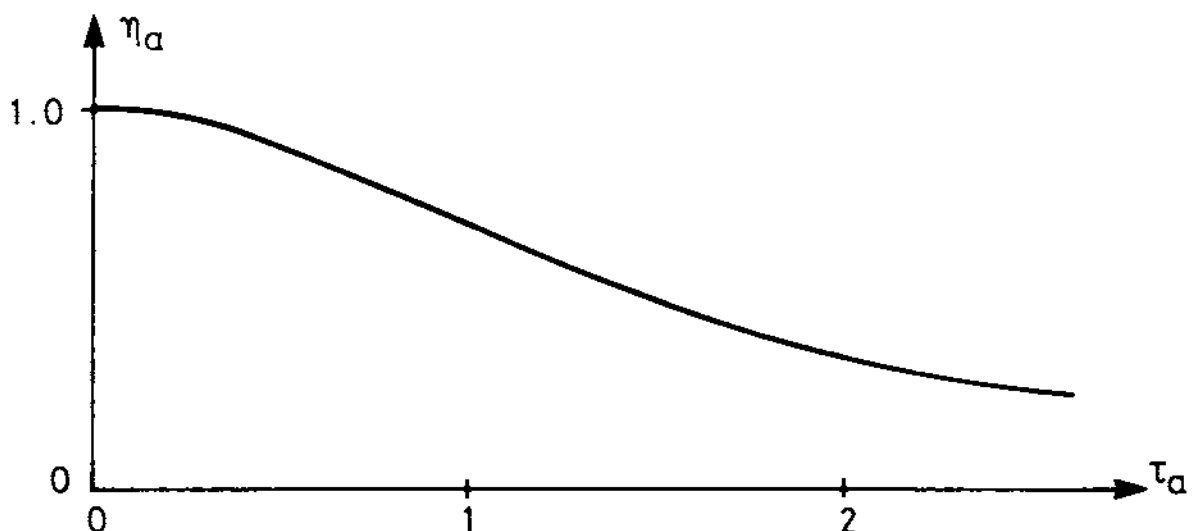

Fig. 7 Variation of acceleration efficiency with normalised acceleration time

3.4 Delivery Phase Model

During the acceleration phase the water in the drive pipe is building up its kinetic energy. It is accelerating because the impulse valve at the bottom of the pipe is open to atmosphere. During the delivery phase this impulse valve is closed and the flow is diverted through the delivery valve which it has forced open against a back head of h' (delivery head plus delivery-pipe headloss). The large net retarding force on the column of water in the drive pipe ($A \times \rho g(h'-H)$) causes it to decelerate rapidly. The detailed mechanism of this retardation is more complex than that assumed in Fig. 5 and comprises a sequence of shock waves travelling up and down the pipe. The overall effect of the delivery phase is to consume the kinetic energy formed during the preceding acceleration phase, using it to pump water. At the end of the delivery phase there is a small residue of kinetic energy that has not been used: this drives a water-recoil process namely the 'recoil phase'.

The transition between acceleration and delivery phases is very complex and must be idealised if algebraic models of tolerable complexity are to result. The sequence is as follows. Once the drive flow Q has exceeded the set threshold Q_{cc} , the impulse valve starts to close (conveniently visualised as a piston moving towards a hole smaller than itself). The flow continues increasing, beyond Q_{cc} , while the piston of the valve accelerates. As the piston gathers significant speed the fraction of the flow pressing *round* the piston decreases while the fraction *following* the piston increases (the latter is equal to piston area times piston velocity). The *velocity* of the former however increases, since the annulus through which it has to pass is rapidly getting thinner, causing the back pressure behind the piston to rise. The acceleration of the drivepipe water therefore diminishes and finally goes negative. By this time the piston is close to striking its stop and the first (annulus passing) fraction has a very high velocity manifest as a visible spurt of water above the valve. In the last millisecond of valve closure the exhaust flow falls to zero, the piston hits its stop and the pressure in the pump body rises precipitately to the Joukowski (or water-hammer) head h_j . Provided this is higher than the delivery head h' , the delivery valve will be pushed open and the head will then fall back to $h' + h_L$ where h_L is the friction headloss through the delivery valve. The Joukowski head is thus maintained for a very short time whose duration depends on the velocity of sound, the distance from the impulse valve to the air-water interface above the delivery valve and the inertia of the delivery valve.

This sequence is portrayed in Figure 8 which represents approximately ten milliseconds of the change over between acceleration and delivery phases. The idealised model in Figure 8(b) is suitable for performance predictions but not for estimating the fatigue life of components. The boundary between acceleration and delivery phases has been taken as the instant the pump body pressure head has risen to the drive head H . Modern instrumentation provides ready confirmation of the 'actual' pressure transient but not of the flow transient: velocity sampling every 0.1 milliseconds is too expensive.

In Figure 8(b) the net effect of energy losses (e.g. lost piston KE) during the last instants of valve closure are replaced by a step reduction Q_{cl} in the drive pipe flow. The further drop Q_j corresponds to Joukowski velocity drop in a shock wave whose pressure differential is $\rho g \times (h'' - H)$

$$Q_j = A v_j \quad \text{and} \quad v_j = \frac{g}{c} (h'' - H) \quad [11]$$

where c is the effective velocity of sound in the drive pipe and $h'' = h' + \text{average delivery valve head loss}$. The quantities c and h'' will be discussed later. In our idealised model, which draws upon the work of O'Brien 1933 and Rennie 1980, the delivery phase starts with flow out of the drive pipe (i.e. into the pump body) dropping suddenly from Q_p' to $Q_p' - Q_j$ and the head rising suddenly from H to h'' . This initiates a shock wave that travels up the drive pipe, at speed c to arrive at the drive tank after transit time

$$T = L/c \quad [12]$$

The pressure distribution along the drive pipe is further assumed to have been the static distribution corresponding to steady conditions of no flow, i.e. head equal's zero at the drive tank surface and H at the pump entry. Effectively we are neglecting the effect of drive pipe friction during the delivery phase.

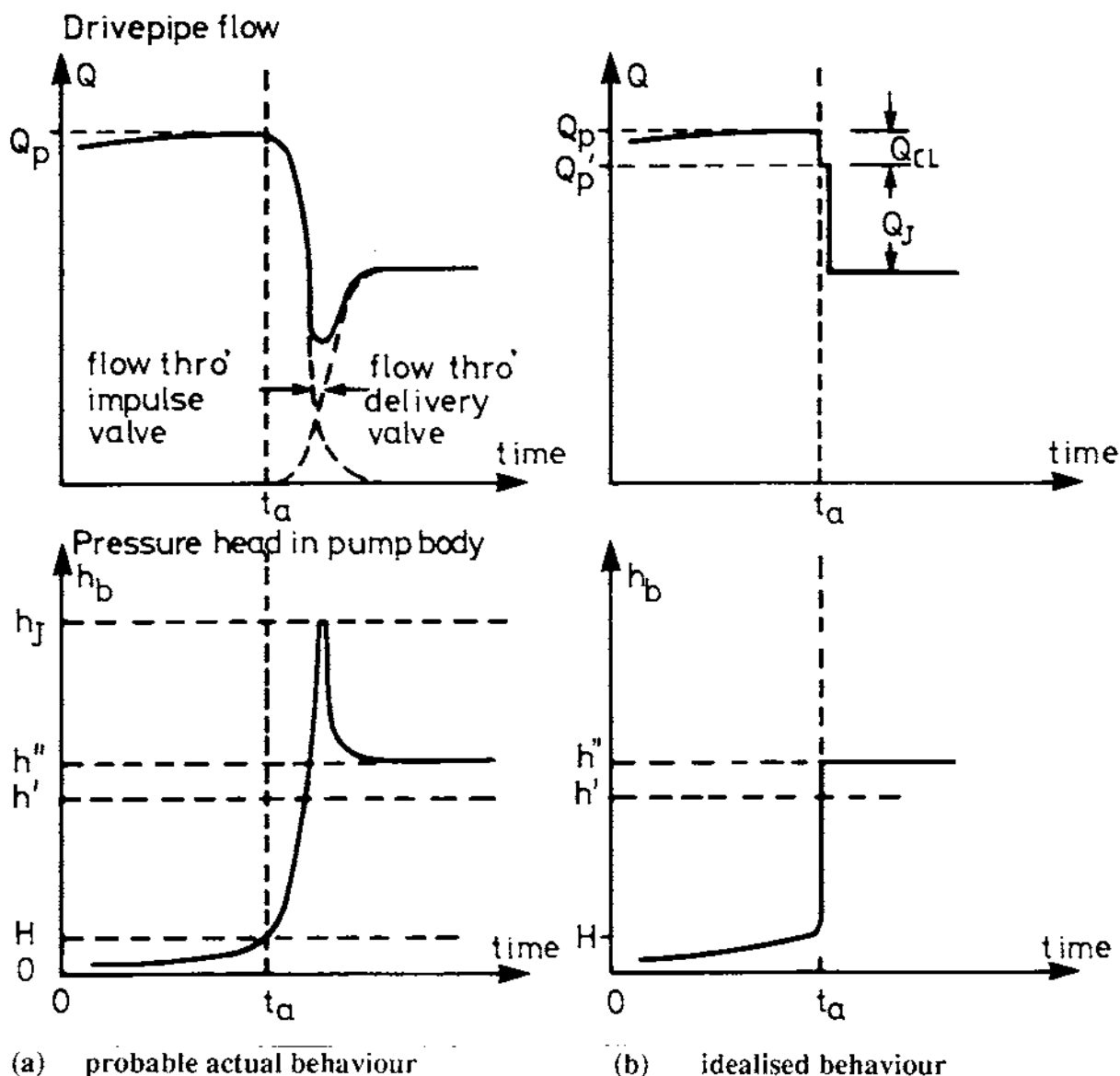

Fig. 8 Transition from acceleration phase to delivery phase (over a few milliseconds around time t_a)

In the acceleration-phase model of section 3.2, behaviour depended on the peak drivepipe water velocity normalised with respect to its maximum possible value; $\lambda_p = v_p/v_\infty = Q_p/Q_\infty$. In the delivery-phase model behaviour depends on the velocity (and flow) normalised with respect to the Joukowski velocity defined in equation [11]. We therefore need to define another normalised flow

$$\mu = Q/Q_J \quad \text{and its initial value } \mu_i = Q_p/Q_J$$

Consider now the flow and pressure at a point in the drive pipe very close to the pump. Its form will be as in Figure 9.

In Figure 9 the shaded area is proportional to the water pumped per cycle. The dashed curve (A) is the behaviour we should expect if the delivery valve were to remain open; however to avoid reverse flow it is designed to close almost instantly. The dashed curve (B) is the projected behaviour

following delivery valve closure. However the negative pressures so generated will usually take the absolute pressure below atmospheric, causing air to be drawn through the (high friction) snifter valve and shortly afterwards through the (low friction) impulse valve when it has reopened a little. Consequently trajectory (C) will be followed.

Figure 9(a) was drawn for $\mu_i = 3.3$ whose integer part is odd. Figure 9(b) shows the different behaviour when the integer part of μ_i is even.

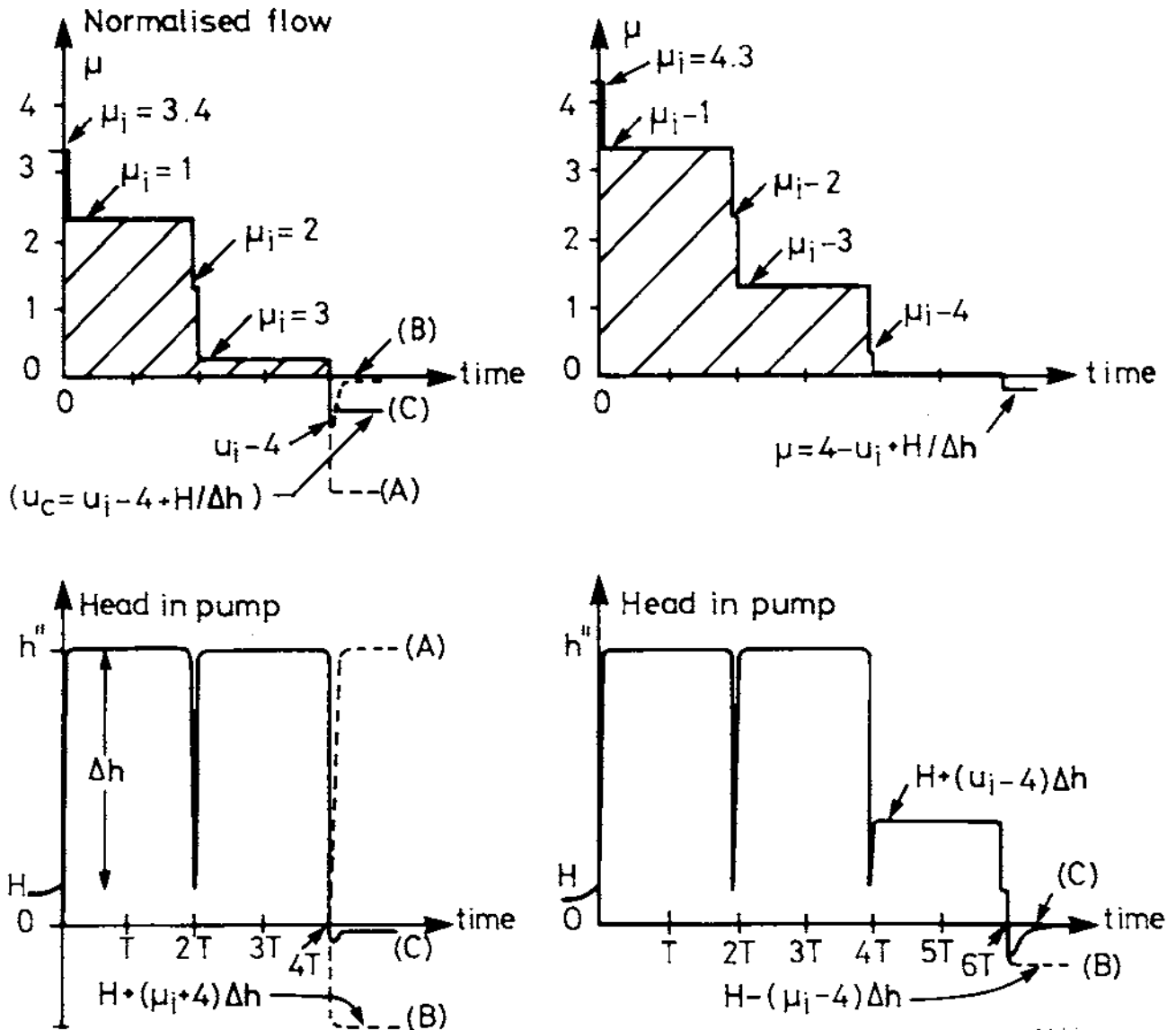

Fig. 9 Pressure and normalised flow at pump entrance

- (A) delivery valve remains open (B) delivery valve closes but impulse valve does not reopen
 (C) actual: delivery closes and impulse reopens

Shaded area indicates normalised volume delivered per cycle

The discussions so far have emphasised the complexity of the delivery phase and the many approximations necessary to achieve a manageable algebraic model. The model developed - one of several possible - does however allow us to answer the following questions:

- how long t_d will the delivery phase last?
- what fraction of the kinetic energy developed during the acceleration phase is used in

- pumping (and what remaining fraction is therefore passed on to the recoil phase)?
- what therefore are the bounds within which μ_i should be tuned to lie?
- what efficiency has the delivery phase?

From the graphs we can see that the duration of the delivery phase is an integer number of 'reflections', where each reflection lasting $2T$ is the passage of a shock wave up the delivery pipe and back. By inspection

$$t_d = 2T (1 + \text{Int}(\mu_i)) \quad \text{where Int}(\) \text{ denotes 'integer part of' and } \mu_i > 1 \quad [14]$$

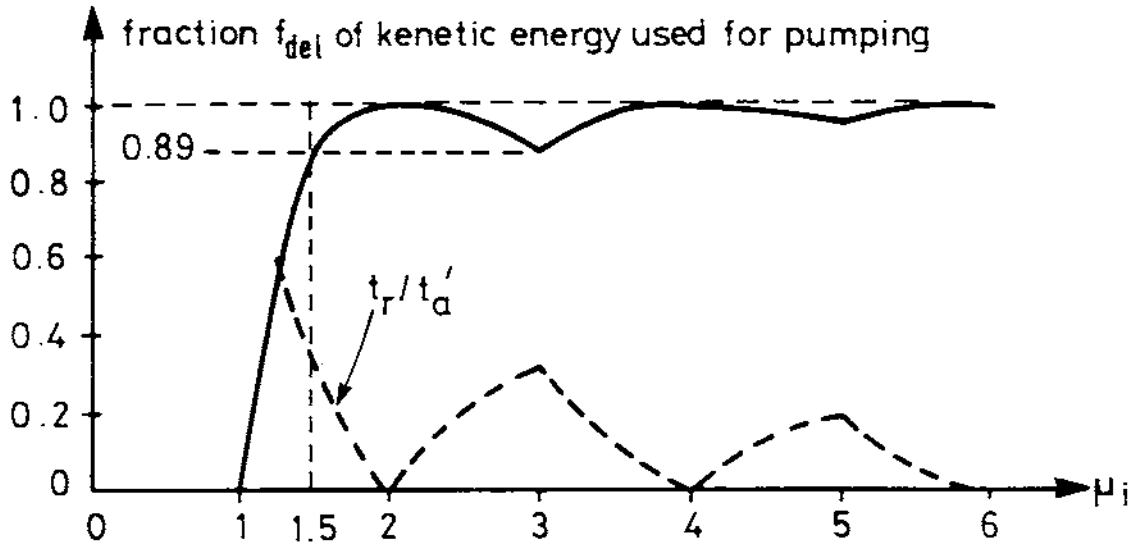

(a) Fraction of available kinetic energy used during delivery phase and recoil time t_r (t'_a is acceleration time if no friction)

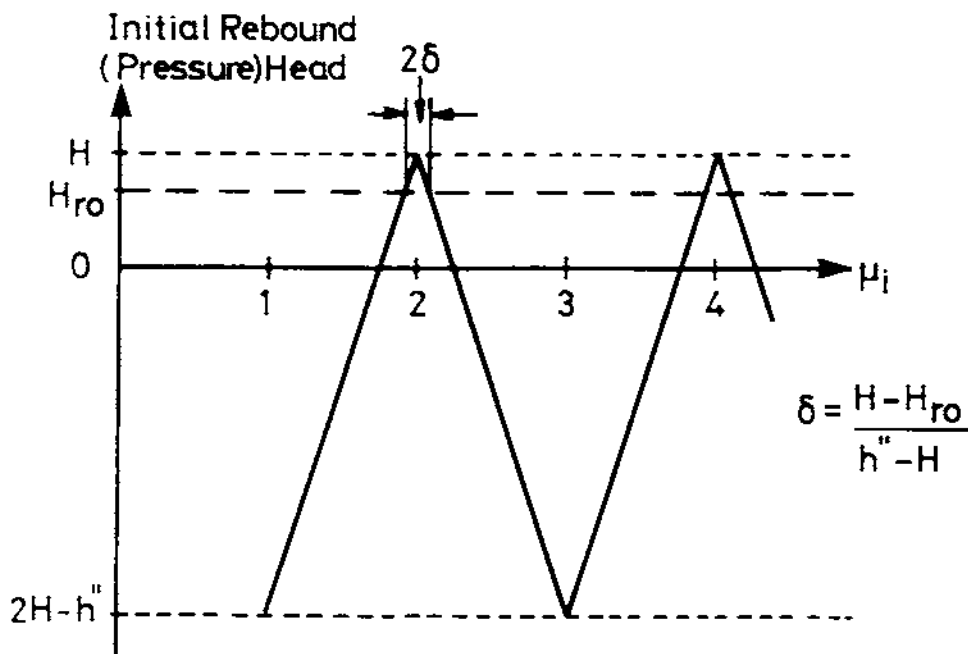

(b) Head in pump body at start of recoil phase
(h_{ro} = head below which the impulse valve reopens)

Fig. 10 Effect of peak flowrate on energy utilisation and rebound

($\mu_i = Q_p/Q_J$ is normalised peak flowrate, where Q_J is the Joukowski flow rate corresponding to effective delivery head h'' . H is drive head)

It can be shown that the fraction of kinetic energy, f_{del} , applied to pumping is the shaded area (the μ - time integral) of Fig. 9 divided by $(0.5 \mu_1 T)$. (For various reasons it is correct with this model to exclude potential energy released by the water flowing down the drive pipe during the *delivery* phase).

The graph is of interest for several reasons. A low fraction (e.g. $f_{del} < 0.9$) indicates a reduced throughput and a reduced efficiency. The throughput is lowered not only because some of the kinetic energy is not used but also because the unused part contributes to a long rebound time (discussed later) which lengthens the cycle of operation and hence reduces the effective power. The efficiency is lowered because any losses while accelerating the water cannot be recovered even though the rebound water returns to the drive tank. The delivered fraction f_{del} is generally acceptable for $\mu_1 > 1.5$ but falls sharply as μ_1 drops below 1.5.

$$\text{From [11] and [13]} \quad \mu_1 = \frac{Q_p' c}{Ag(h''-H)} \quad [15]$$

Low values of μ_1 arise when delivering to very high heads (h'' large), setting the pump flow too low (Q_p' low), or using too large a drive pipe (A large) in combination with a low velocity of sound (c is low in plastic feed pipes). Clearly μ_1 should not fall below 1 (no output) and it would be unwise to drop below $\mu_1 = 1.5$ (at which use-fraction is only $f_{del} = 0.89$).

Lastly there is the matter of delivery phase inefficiency. This has been represented by an additional friction head during delivery, increasing effective delivery height h' to h'' .

We can therefore define

$$\text{delivery valve efficiency} \quad \eta_{dv} = h' / h'' \quad [16]$$

where delivery valve headloss is

$$h'' - h' = \frac{C_{dv}}{2g A_{dv}^2} \overline{q_{dv}^2} \quad [17a]$$

The delivery valve water-flow area A_{dv} can be measured. The loss coefficient C_{dv} will lie between 0.8 and 1.2. The mean square value of q_{dv} is not easy to estimate. The instantaneous delivery flow q_{dv} has the staircase waveform shown in Figure 9, and therefore magnitude $Q_p' \times \mu / \mu_1$. The flow-weighted mean-value of $(\mu/\mu_1)^2$ rises from zero (at $\mu_1 = 1$) to 0.45 (at $\mu_1 = 3$) and then stays approximately constant for $\mu_1 > 3$. In practice friction losses in the delivery valve are significant only at relatively low delivery heads and hence at large values of μ_1 . For this condition and via a series of approximations we can come to

$$h'' - h' = \frac{0.4 Q_p'^2}{2g A_{dv}^2} = \frac{Q_d^2}{12 A_{dv}^2} \quad \text{which is accurate within } \pm 30\% \quad [17b]$$

A pump designer can use equations [16], [17b] in combination with the maximum value of Q_d and minimum value of h' to decide whether the valve area A_{dv} is sufficient.

3.5 Recoil-phase Model

Water velocities during recoil are small so do not result in significant friction losses. Our interest in the recoil phase therefore centres on (i) whether the recoil suction is sufficient to reopen the impulse valve, and (ii) how long the recoil phase lasts.

From inspection of Figure 9 it can be seen that the initial rebound pressure satisfies Figure 11. However there exists a head H_m above which the impulse valve will not reopen and the pumping cycle will not continue. In Figure 11 the zones of width 2δ indicate values of μ_i for which the rebound is inadequate. In an operational pump with a *weighted* impulse valve H_m is never greater than the drive head H , and is usually much less. As a first approximation we can take H_m as zero in which case:

$$\delta = H/(h'' - H) = 1/(R - 1) \quad [18]$$

As $\delta = 1$ represents the valve not reopening at *any* value of μ_i (any flow setting), R should never drop below 2 and it would be risky to use values of R below say 5 (25% chance of impulse valve failing to reopen). In practice the approximation behind [18] is a drastic one; however the observed phenomena of pumps being difficult to run at low head ratios and very high drive heads is confirmed. A pump with a *sprung* rather than weighted impulse valve will have a much higher value for H_m , usually higher than H in fact. Such pumps are therefore much less liable to failure of the impulse valve to reopen.

The simplest model of the rebound process is an energy one. An acceleration phase of duration t_a results in the drive pipe water having a certain kinetic energy. At the end of the delivery phase a fraction approximately $(1 - f_{del})$ of this energy remains which should cause a rebound of duration

$$t_r = t_a \times \sqrt{1 - f_{del}} \quad [19]$$

This data is also plotted in Figure 10.

This analysis assumes constant acceleration/deceleration for a given pipe slope: it thus neglects friction effects which if included would reduce t_r/t_a by typically several percent. It also assumes instantaneous reopening of the impulse valve, whereas in practice this is so delayed by inertia that some of the rebound energy is expended in sucking air through the tiny snifter valve hole. More fundamentally, the model assumes that during rebound the water column recedes, unbroken, back up the drive pipe. In reality water and air mix and their interface is geometrically very complex. Equation [19] may be taken to give a crude estimate of the rebound time t_r . It shows that under many operating conditions t_r is not negligible and is especially large when μ_i is close to 1 (i.e. when the necessary delivery head can only just be achieved).

3.6 Combining Acceleration, Delivery and Recoil Models

In the previous sections three models have been discussed. For the acceleration phase a lumped-system model has been used, for the delivery phase a distributed-system model (with reverberating shock waves), and for the rebound phase again a lumped system model. In practice shock waves continue to roam the drive pipe water column during rebound and die away during the subsequent acceleration phase. An algebraic model to represent these would be intolerably complex and add little to accuracy. The transition from phase to phase is complex and could only be fully modelled if the dynamics (drag, mass etc.) of valves were included. The transition from acceleration to delivery and from delivery to recoil entail irreversibilities that cause loss of work energy. The first is represented by the drop Q_{cl} in delivery flowrate shown in Figure 8, which reduces both efficiency and throughput. The second energy loss, at the start of the rebound phase, arises from any backflow through the

delivery valve, any air or water friction in the snifter, or cavitation. It affects efficiency unfavourable but throughput favourably (since rebound time will be reduced).

During acceleration and rebound the impulse valve is open to atmosphere, and pressures at the bottom of the drive pipe have been related to atmospheric. During delivery, however, the impulse valve is closed and the model used has related pressures (heads) to a datum at the surface of the drive tank height H higher. The change in datum has hidden certain minor energy transactions (kinetic energy to strain energy). The acceleration, delivery and rebound models can be combined as follows:

$$\text{cycle time} \quad t_a = t_a + t_d + t_r \quad [20]$$

where the constituent times are defined by equations [9], [14] and [19] and Table 2.

$$\begin{aligned} \text{efficiency} \quad \eta &= \eta_{nr} = \eta_a \cdot \eta_{ad} \cdot \eta_{dr} && \text{in the absence of recoil} \\ \eta &= \frac{\eta_{nr} f_{del}}{1 - \eta(1 - f_{del})} && \text{if recoil is significant} \end{aligned} \quad [21]$$

where η_a and η_{dv} are defined by equations [10] and [17], f_{del} by Fig. 10 and the acceleration-to-delivery handover efficiency η_{ad} is typically 0.97.

$$\text{delivered power} \quad P = P_a \cdot \eta_{ad} \cdot \eta_{dv} \cdot f_{del} \cdot t_a/t_c \quad [22]$$

where acceleration power P_a is given by equation [10].

$$\text{drive flow} \quad Q_d = \frac{Q_p}{2} \frac{f_{del} + 1/R}{1 + 1/R + \sqrt{1 - f_{del}}} \quad [23]$$

obtained by dividing drive volume per cycle (allowing for recoil flow) by cycle time (including recoil time).

Putting the three phases together gives Figure 11.

From this graph it can be seen that mean drive flow Q_d is usually considerably less than the flow Q_{cc} at which closure commences. (Q_{cc}/Q_d is typically between 1.5 and 2.0). This yields the rule of thumb

Rot 6. "If the source flow falls temporarily below the pump's mean drive flow Q_d the pump will stop, usually with its impulse valve open. To restart the pump without human intervention the source flow must increase to a level 1½ to 2 times Q_d ".

This rule implies that after a drive flow interruption pumps usually fail to restart without human intervention. This is a serious inconvenience in practice.

4. THE APPLICATION OF ALGEBRAIC MODELS

In the introduction to this paper reference was made to the need to explain behaviour, prepare performance graphs/tables and develop rules for system design, pump tuning and pump design. Six such 'rules' were developed in the course of model building (section 3 above). Many more might be devised. The purpose of this concluding section is to illustrate the use of algebraic models via some examples.

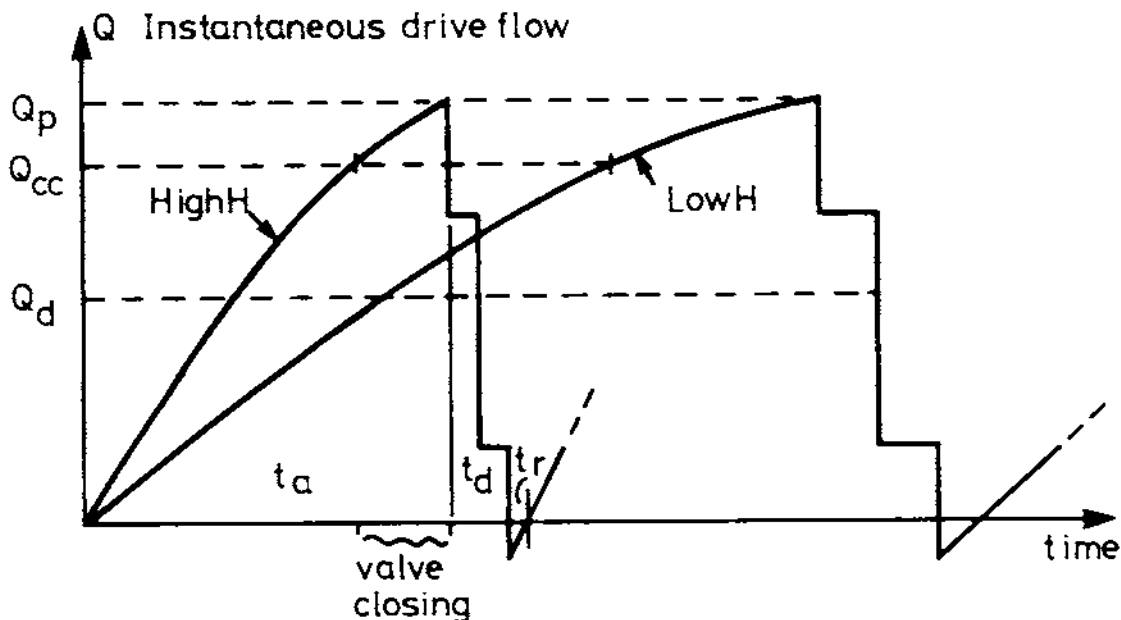

Fig. 11 Driveflow over a complete cycle for high and low driveheads
(Q_p is peak driveflow, Q_{cc} is driveflow to start valve closure, Q_d is mean driveflow)

4.1 Explaining Phenomena and Improving Pump Design

Ram-pumps, for all their mechanical simplicity, display complex and sometimes 'temperamental' behaviour. Reasons for the latter include operation too close to some limit, and blockages and leakages in pipes. Two major causes of erratic operation are the presence of excess air in the drive system (often due to excessive recoil at the end of the delivery phase) and the failure of the impulse valve to reopen (insufficient recoil). Algebraic models help us understand both phenomena.

The recoil can be expressed as an energy fraction ($1 - f_{del}$, where f_{del} is illustrated in Fig. 10(a)), a time fraction (Fig. 13) or a distance:

$$\text{rebound distance} \quad L_r = (1 - f_{del}) \frac{v_p^2}{2gS} \quad [24]$$

where f_{del} is determined by the ratio μ_i of Joukowski head to delivery head. The term $v_p^2 / 2gS$ is rarely greater than 100 cm, and $1 - f_{del}$ is less than 0.11 for all μ_i greater than 1.5 (see Fig. 10a). So L_r rarely exceeds 10 cm.

Excessive recoil is that which draws so much air back into the drive pipe that it is not swept out during the ensuing acceleration phase. Whether this occurs depends on L_r and the pump design. It is least likely to do so if the pump discharges under water or rises more than 10 cm from its drive pipe entry to its delivery valve. Conversely, air entrainment is most likely when the delivery head is near

the maximum possible for the drive flow chosen ($\mu_i < 1.5$), or when a high-flow pump has a low-set impulse valve.

Failure to reopen due to lack of recoil occurs when the pump is most efficient: $f_{del} = 1.0$ at $\mu_i = 2$ or 4 or 6 etc.. This is illustrated in Fig. 10(b), where a zone of width $\Delta\mu_i = 2\delta$ is shown around each even value of μ_i . Within this zone the pump may fail to reopen. Equation [18] indicates a relationship between δ and the head-ratio R , suggesting serious probability of failure to reopen at low head-ratios. However *any* such failure is inconvenient. During start-up, when a pump generally fills up a delivery pipe from the bottom, the Joukowski ratio μ_i falls with each pump stroke. Such start-up requires the continuous attention of an operator if the pump may stop whenever μ_i is close to an even number. Even worse the final full delivery head may correspond to $\mu_i = 2$ so that reliable operation is impossible until the pump is slightly retuned to change Q_p and (via the Joukowski head h_j) μ_i . Equation [18] is a special case of the more general relation:

$$\text{width of failure zone } 2\delta = 2(H - H_{ro}) / (h' - H) \quad [24]$$

So ideally we should like the head against which the impulse valve will just reopen (H_{ro}) to exceed the drive head H . The advantages and costs of raising H_{ro} may be observed from the following graph of impulse valve closure. Note that H_{ro} may be re-expressed as a force F_{ro} keeping the valve closed ($F_{ro} = H_{ro} \cdot \rho g \cdot \text{valve area}$) which a spring force or the valve's weight must just equal and oppose.

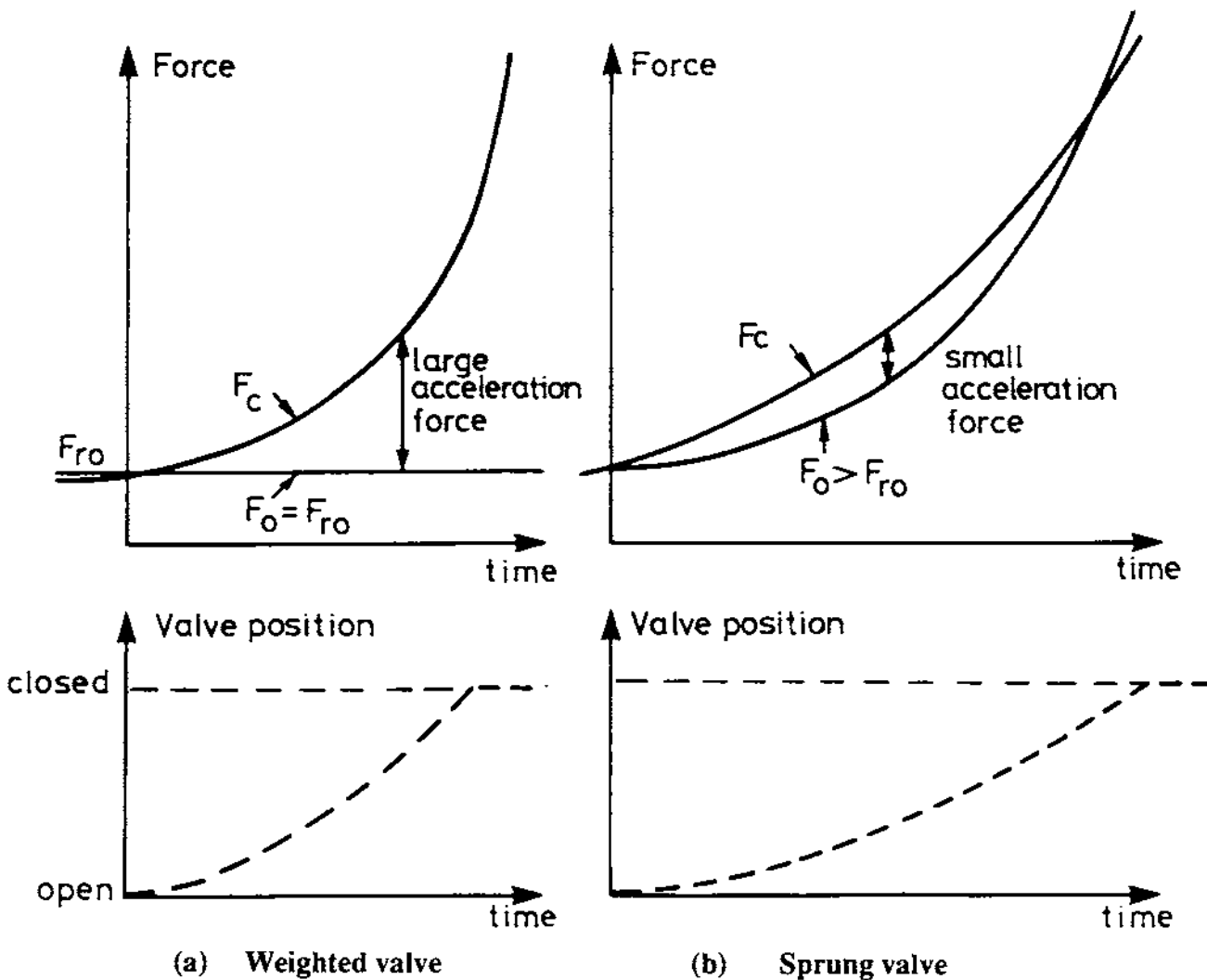

Fig. 12 Forces and position variation during impulse valve closure
 (F_c = closure force due to water drag; F_o = opposing force; time is measured from start of valve closure)

Thus the use of a sprung impulse valve whose 'opposing force' rises as the valve closes (Fig 12(b)) can give a much higher figure for F_{ro} and hence H_{ro} than a merely weighted impulse valve will (Fig. 15(a)). A pump with the former is therefore less likely to stop, provided the valve's much slower closure doesn't cause other problems.

For the pump designer many issues - and desirable proportions - have been raised in the course of the analysis. Impulse valve and delivery valve losses should be tolerable at maximum drive flow. The last stage of impulse valve closure should take less time than that for a shock wave to traverse up and down the drive pipe. An impulse valve that will reopen against full drive head should reduce the chance of maverick operation. Certain design details cannot however be decided using the algebraic models of section 3. In particular the dynamics of the opening and closing of the two main valves require more specialised models to predict velocities and accelerations, peak stresses, back leakages and so on. Time step simulations have application to these tasks.

4.2 Calculating Pump Characteristics

It was argued in Section 2 that the pump and its drive pipe should be treated as an inseparable system for performance characterisation. The many equations of section 3 can be combined to obtain performance predictions of varying degrees of accuracy. It is difficult to avoid iterative calculations since the equations are numerous and complex. However an approach of adequate accuracy for practical purposes is as follows:

A peak flow Q_p is selected.

The maximum possible flow Q_m is calculated from H, S, h', A, k_d and k_p .

The normalised peak flow $\lambda_p = Q_p/Q_m$ is obtained and used to predict acceleration efficiency η_a and mean acceleration flow \bar{Q}_a . The Joukowski flow is obtained (Q_j) and used to obtain the Joukowski ratio $\mu_1 = Q_p/Q_j$. A modified value Q_p' may be used if the acceleration-to-delivery transition efficiency η_{ad} can be estimated. From this ratio μ_1 the energy delivery fraction f_{del} can be derived and any possibility of malfunction can be identified ($\mu_1 = 2, 4, 6$ etc. $\mu_1 < 1.5$).

From Q_p and delivery valve geometry, the delivery valve efficiency η_{dv} is estimated. The efficiencies and energy fraction are combined using equation [21] to give an overall efficiency η . The drive flow Q_d is obtained to varying levels of accuracy using Q_a or better equation [23]. Delivery flow q can now be calculated using equation [1].

Using a sequence of values for peak flow Q_p , a table or graph of delivery flow q versus drive flow Q_d is thus obtained. Other equations can be used to obtain cycle time, although this is rarely tabulated.

4.3 System Design

System design can be undertaken using performance charts or graphs for a range of pump/drive pipe combinations: the lowest-cost option capable of meeting a specification should be chosen. This approach requires many such graphs and the ability to interpolate reliably between them. Alternatively, likely candidate systems can be evaluated using a computer programme to generate delivery flow versus driveflow loci. Unfortunately neither of these approaches fits the situation

frequently met with in the field, where computers are remote and water technicians not very numerate. Rules of thumb also have their place.

Consider the difficult task of choosing drivepipe diameter and slope. The drivepipe pressure rating needs, incidentally, to be about twice the *delivery* pressure to limit fatigue failure and the drive pipe should be able to withstand negative heads down to $-H$.

Slope S is usually site-constrained: it is difficult to lay a pipe steeper than the valley side. Low slopes are expensive (the drive pipe is long) and inefficient. Very high slopes give a high operating cadence (and thus high noise and a short pump life), low efficiency through increased frequency with which valve closure losses occur, and possibility of impulse valve malfunction due to too short a drive pipe.

Too large a drivepipe diameter D result in excessive drivepipe cost and peak velocities too low to generate the required delivery pressure. Too small a diameter results, for a given drive flow, in excessive acceleration phase losses and low overall efficiency.

It has already been argued that for reliable operation the Joukowski ratio should not fall below 1.5. This can be expressed as a *upper* limit on pipe size. Noting that at $\mu_1 = 1.5$, $Q_p = 3Q_d$ and $A = 0.67 c Q_p / g (h-H)$, we need to know the effective wave speed c to derive any specific rules. For steel pipes we should use $c = 1400$ m/s and for PVC pipes (of wall thickness one-tenth of their diameter) $c = 400$ m/s. These lead to the rough rule of thumb.

*ROT.7 "For steel pipes, drive pipe diameter in mm should not exceed
 $600 \sqrt{\text{drive flow in litres / sec} \div \text{delivery head in meters}}$;
for PVC pipes replace 600 by 300"*

A *lower* limit for pipe diameter in combination with pipe slope can be obtained by ensuring Q_p/Q_{oc} does not exceed 0.8, yielding $Q_{oc}/Q_d > 2.5$. However Q_{oc} is the maximum flow obtained when drive pipe and pump together are left to run with an open impulse valve. The flow through an open-ended drive pipe alone, laid down the slope, would be higher. By a series of assumptions one can arrive at a rule:

ROT.8 "The drive pipe diameter and slope must be sufficient that its flow open-ended, the pump having been removed, is at least 3.5 times the intended drive flow".

4.4 Tuning

The contribution of algebraic models to achieving good pump tuning is not very great. Tuning of ram-pumps on site is not essential, as a pump set for a mid-range drive flow will operate on most sites. Indeed with some operators the provision of a means of tuning may be unwise: the pump is then vulnerable to gross maladjustment. Where the pump is tuneable, by variation of the flow Q_{cc} at which impulse valve closure begins, heuristic methods are often adequate: the operator finds by experiment the setting that maximises delivery flow within the limits of available source flow. Only when several pumps are operated in parallel is this trial-and-error approach likely to prove difficult.

An operator usually has little data with which to work. On many sites the pump cycle time is the only easily measured variable; drive flow and waste flow may be inconvenient to gauge, delivery flow is measurable but only at the delivery tank sited many minutes climb away from the pump house. Unfortunately cycle-time is not simply related to the flow variables of interest. Figure 13 shows cycle time, drive flow and delivery flow as functions of Joukowski ratio μ ; itself a measure of peak flow and hence of tuning. The plot is for a representative system and displays considerable complexity.

No simple tuning rule for finding a high efficiency point (such as $\mu = 2$) by observing cycle time suggests itself.

With knowledge of site parameters and in particular of drivepipe diameter, an installer or manufacturer can pre-set a pump's tuning Q_{cc} to a suitable value, or can constrain it to lie within a particular range of flows. A suitable range might be that which makes μ_i lie in the narrow band $1.25 < \mu_i < 2$, or the wider band $1.5 < \mu_i < 4$. The lower limit prevents the pump being tuned to give negligible delivery or to entrain air. The upper limit prevents use of unnecessarily high drive flow and also protects the pump for excessive over-pressures should its delivery become blocked. The optimum range will depend on the ratio of open-pump flow Q_∞ to Joukowski flow Q_J .

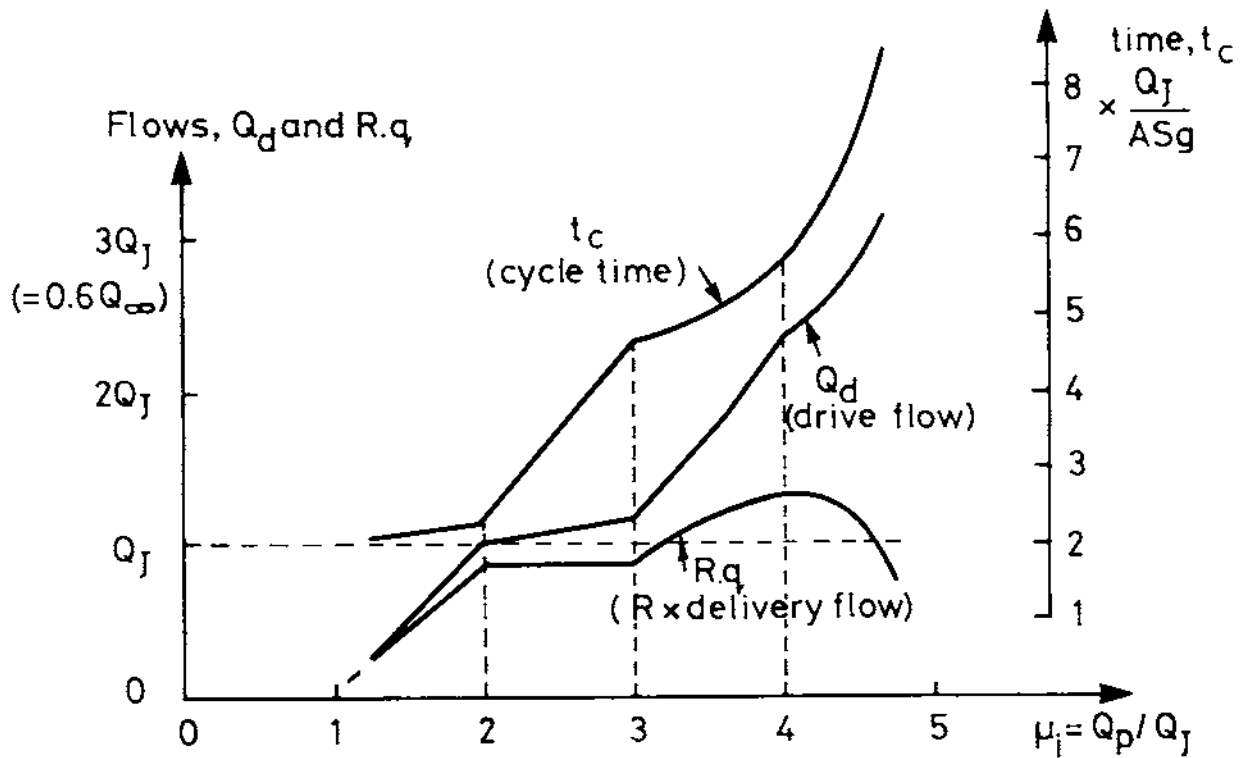

Fig. 13 Driveflow, delivery flow and cycle time variation with tuning

(Q_J is flow just sufficient to attain delivery head, t_c is cycle time, Q_d is driveflow, q is delivery flow, assuming $Q_\infty = 5Q_J$ $R = 20$ $\eta_{dv} = 0.9$)

5. CONCLUSIONS

The three main phases - acceleration, delivery and recoil - of a ram-pump cycle have been modelled using equations of manageable simplicity. Several rules of thumb have been derived. The paper has throughout stressed the application of algebraic modelling to solve common problems in system design and tuning.

Equation [1] in section 3.2 represents the level of modelling usually employed by manufacturers in the preparation of data sheets. This paper has shown that its assumption of constant efficiency is unreasonable and its objective of describing the performance of a pump in isolation (from its drive pipe) is unrealistic. Such simple models are incapable of explaining many phenomena important to pump users. Through the use of two ratios ($\lambda = Q_p / Q_\infty$ and $\mu_i = Q_p / Q_J$) much more can be explained, even though the peak flow Q_p itself can not be readily measured. The several approximations and omissions in the model developed make it inadequate for some aspects of pump design optimisation, for which complex simulation models are preferable.