

# Etiquettes de sécurité

**Commandez vos étiquettes de sécurité**  
sur vinyle adhésif, PVC ou Aluminium



**LE + PREVENTI !**

*Personnalisez votre panneau :  
nous le réalisons au même prix !*



**Toute la gamme  
en 1 seul clic**

## Panneaux d'avertissement et de signalisation de risque ou de danger

### Caractéristiques :

- Forme triangulaire ou rectangulaire ;
- Pictogramme noir sur fond jaune, bordure noire (le jaune doit recouvrir au moins 50% de la surface du panneau).

### Exemple de panneaux à utiliser :



W001  
Danger Signal général



W002  
Danger Matières explosives



W003  
Danger Matières radioactives  
ou radiations ionisantes



W004  
Danger Rayonnement laser



W005  
Danger Radiations non  
ionisantes



### CONSEIL

## Comment choisir son format de panneau ?

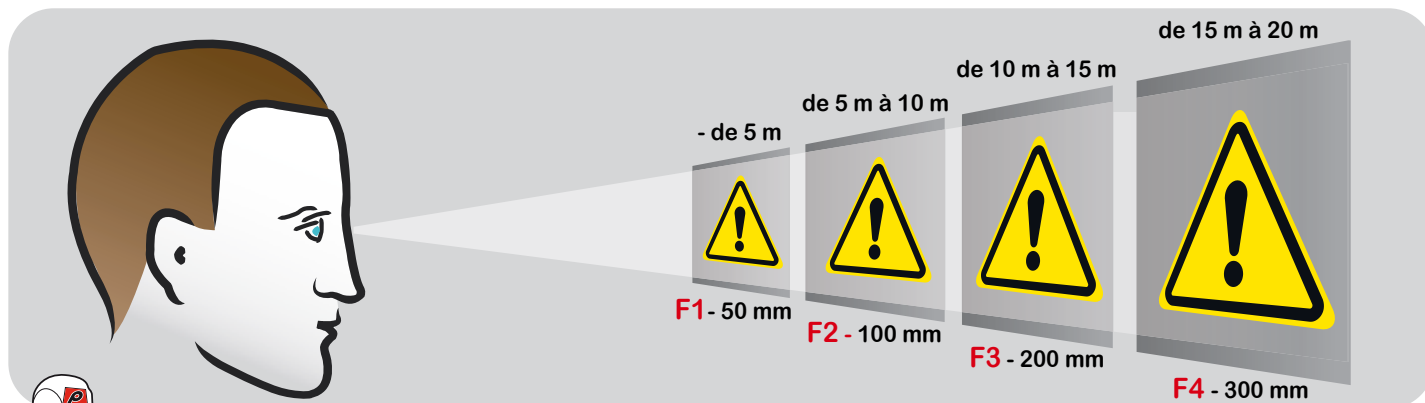

### CONSEIL

## Comment choisir sa matière ?

### Adh

#### Adhésif

Sur surface lisse. Intérieur ou extérieur.  
Très bonne résistance aux UV, graisses et solvants  
Très bonne adhérence finale offrant une excellente tenue sur une grande variété de supports.

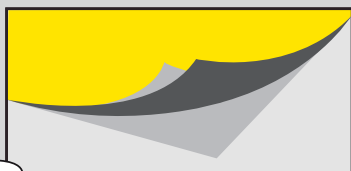

### PVC Plaques PVC 1.5 mm

Sur surface lisse. Intérieur.  
Plaque rigide à structure allégée.  
Classée au feu M1  
Stabilité au vieillissement.

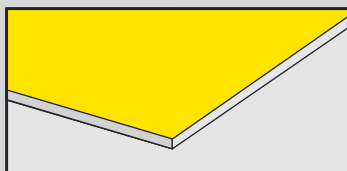

### Alu Plaques ALU 2 mm

Sur toutes surfaces. Extérieur.  
Rigidité équivalente à celle d'une plaque d'aluminium pleine de 1,8 mm  
Très résistante aux chocs et aux intempéries.  
Résistance de - 50°C à + 90°C  
Classée au feu M1

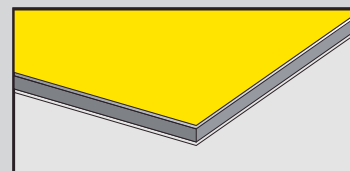

### CONSEIL

## Comment composer sa référence pour commander ?

La référence complète se compose d'une lettre et 3 chiffres pour la référence définissant le motif du panneau suivis de son format (F1, F2, F3 ou F4) et enfin de sa matière (Adh, PVC ou Alu).  
Exemple : **W002-F2-Adh** pour un panneau **Danger matières explosives** au **Format 2** (100 mm de largeur) en **Adhésif**.



## Pictogrammes - Etiquettes - Panneaux Prévention



La **nouvelle norme ISO 7010** a été mise à jour en avril 2013  
Certains panneaux sont remplacés par une version plus universelle  
Preventimark vous garantit des panneaux conformes à la nouvelle  
législation en vigueur.

Formats en mm	Matières	Adh Vinyle adhésif	PVC 1,5 mm tranche blanche	Alu 2 mm tranche noire
<b>F1</b>	50 x 50	1.25 € HT	2.50 € HT	3.75 € HT
<b>F2</b>	100 x 100	2.50 € HT	5.00 € HT	7.50 € HT
<b>F3</b>	200 x 200	7.00 € HT	10.50 € HT	15.75 € HT
<b>F4</b>	300 x 300	12.00 € HT	18.00 € HT	23.40 € HT

Les caractères de couleur **ROUGE** du tableau vous permettent  
de composer votre référence produit. Exemple : W003-F3-PVC

Franco de port à partir de 300 € HT



**W001**  
Danger Signal général



**W002**  
Danger Matières explosives



**W003**  
Danger Matières radioactives  
ou radiations ionisantes



**W004**  
Danger Rayonnement laser



**W005**  
Danger Radiations non  
ionisantes



**W006**  
Danger Champ magnétique



**W007**  
Danger Trébuchement



**W008**  
Danger Chute avec  
dénivellation



**W009**  
Danger Risques biologiques



**W010**  
Danger Basses  
températures, conditions  
de gel



**W011**  
Danger Surface glissante



**W012**  
Danger Electricité



**W013**  
Danger Chien de garde



**W014**  
Danger Chariots élévateurs  
à fourche et autres  
véhicules industriels



**W015**  
Danger Charges  
suspendues



**W016**  
Danger Matières toxiques



**W017**  
Danger Surfaces chaudes



**W018**  
Danger Démarrage  
automatique



**W019**  
Danger Ecrasement



**W020**  
Danger Obstacle en  
hauteur



**W021**  
Danger Matières inflammables



**W022**  
Danger Élément pointu



**W023**  
Danger Substances corrosives



**W024**  
Danger Ecrasement des mains



**W025**  
Danger Rouleaux  
contrarotatifs



## Pictogrammes - Etiquettes - Panneaux Prévention



La **nouvelle norme ISO 7010** a été mise à jour en avril 2013  
Certains panneaux sont remplacés par une version plus universelle  
Preventimark vous garantit des panneaux conformes à la nouvelle  
législation en vigueur.

Matières	Adh Vinyle adhésif	PVC 1,5 mm tranche blanche	Alu 2 mm tranche noire
<b>F1</b> 50 x 50	1.25 € HT	2.50 € HT	3.75 € HT
<b>F2</b> 100 x 100	2.50 € HT	5.00 € HT	7.50 € HT
<b>F3</b> 200 x 200	7.00 € HT	10.50 € HT	15.75 € HT
<b>F4</b> 300 x 300	12.00 € HT	18.00 € HT	23.40 € HT

Les caractères de couleur **ROUGE** du tableau vous permettent  
de composer votre référence produit. Exemple : W003-F3-PVC

Franco de port à partir de 300 € HT



**W026**  
Danger Charge de la  
batterie en cours



**W027**  
Danger Rayonnement  
optique



**W028**  
Danger Substances  
comburantes



**W029**  
Danger Bouteille pressurisée



**W150**  
Danger haute tension



**W151**  
Matières nocives  
ou irritantes



**W152**  
Atmosphère explosive

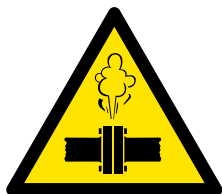

**W153**  
Vapeurs chaudes



**W154**  
Risque d'asphyxie



**W155**  
Attention à la marche



**W156**  
Attention à la marche



**W157**  
Risque de glissade



**W158**  
Attention à la tête



**W159**  
Danger niveau sonore



**W160**  
Electrostatique



**W161**  
Surveillance vidéo



**W162**  
Attention à vos mains



**W163**  
PCB



**W164**  
Attention à vos mains



**W165**  
Toute flamme interdite



**W166**  
Attention charge lourde



**W167**  
Risque de noyade



**W168**  
Danger de coupure



**W169**  
Attention maintenance

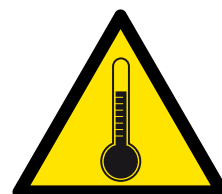

**W170**  
Danger haute température





## Pictogrammes - Etiquettes - Panneaux Prévention

Panneaux d'avertissement et de signalisation de risque ou de danger  
Conformes aux normes européennes pour la signalisation de sécurité  
et la santé sur les lieux de travail (Directive 92/58 du 24 juin 1992)

Formats en mm	Matières	Adh Vinyle adhésif	PVC 1,5 mm tranche blanche	Alu 2 mm tranche noire
F1	50 x 50	1.25 € HT	2.50 € HT	3.75 € HT
F2	100 x 100	2.50 € HT	5.00 € HT	7.50 € HT
F3	200 x 200	7.00 € HT	10.50 € HT	15.75 € HT
F4	300 x 300	12.00 € HT	18.00 € HT	23.40 € HT

Les caractères de couleur **ROUGE** du tableau vous permettent  
de composer votre référence produit. Exemple : W003-F3-PVC

Franco de port à partir de 300 € HT



**W171**  
Danger Rayons X  
batterie en cours



**W172**  
Danger Attention à vos mains,  
fumée, soudure

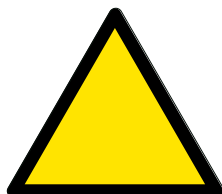

**W173**  
Danger



**W174**  
Danger Piéton



**W175**  
Danger Pan incliné

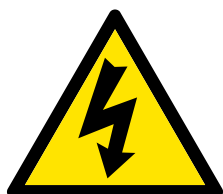

**W176**  
Danger Electricité



**W177**  
Danger Electricité



**W178**  
Danger Atmosphère explosive



**W179**  
Bouteille de gaz



**W180**  
Bouteille de gaz vide



**W181**  
Danger Fûts



**W182**  
Danger Rayonnement laser



**W183**  
Risque de trébuchement



**W184**  
Haute tension



**W185**  
Chariot élévateur et autre  
véhicules industriels



**W186**  
Attention à la pente



**W187**  
Risque de trébuchement



**W188**  
Risque de chute avec  
dénivellation



**W189**  
Risque de chute



**W190**  
Danger Escaliers



**W191**  
Attention Surface glissante



**W192**  
Attention Surface glissante



**W193**  
Attention Surface fragile



**W194**  
Attention Risques cancérigène



**W195**  
Risque d'inhalation



## Pictogrammes - Etiquettes - Panneaux Prévention

Panneaux d'avertissement et de signalisation de risque ou de danger  
Conformes aux normes européennes pour la signalisation de sécurité  
et la santé sur les lieux de travail (Directive 92/58 du 24 juin 1992)

Formats en mm	Matières	Adh Vinyle adhésif	PVC 1,5 mm tranche blanche	Alu 2 mm tranche noire
F1	50 x 50	1.25 €HT	2.50 €HT	3.75 €HT
F2	100 x 100	2.50 €HT	5.00 €HT	7.50 €HT
F3	200 x 200	7.00 €HT	10.50 €HT	15.75 €HT
F4	300 x 300	12.00 €HT	18.00 €HT	23.40 €HT

Les caractères de couleur **ROUGE** du tableau vous permettent  
de composer votre référence produit. Exemple : W003-F3-PVC

Franco de port à partir de 300 € HT



W196  
Danger Risque d'asphyxie



W197  
Risques toxiques pour les  
organismes aquatiques



W198  
Attention Ralentisseur



W199  
Danger Poids lourds



W200  
Danger Poids lourds



W201  
Attention Engins de chantier



W202  
Attention aux trains



W203  
Danger



W204  
Carburant

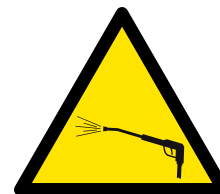

W205  
Nettoyeur haute-pression



W206



W207  
Point d'ancrage



W208  
Attention Charge suspendue



W209  
Attention Charge suspendue



W210  
Surveillance vidéo



W211  
Attention aux mains  
Engrenages



W212  
Attention aux mains  
Engrenages



W213  
Attention aux mains  
Engrenages



W214  
Attention aux mains  
Engrenages



W215  
Attention aux mains  
Risque d'écrasement



W216  
Attention aux mains  
Risque de sectionnement



W217  
Attention aux mains  
Risque de coupe

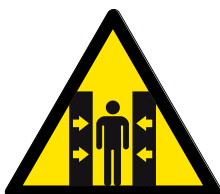

W218  
Attention risque d'écrasement



W219  
Attention risque d'écrasement



W220  
Attention risque d'écrasement



## Pictogrammes - Etiquettes - Panneaux Prévention

Panneaux d'avertissement et de signalisation de risque ou de danger  
Conformes aux normes européennes pour la signalisation de sécurité  
et la santé sur les lieux de travail (Directive 92/58 du 24 juin 1992)

Matières	Adh Vinyle adhésif	PVC 1,5 mm tranche blanche	Alu 2 mm tranche noire
<b>F1</b> 50 x 50	1.25 €HT	2.50 €HT	3.75 €HT
<b>F2</b> 100 x 100	2.50 €HT	5.00 €HT	7.50 €HT
<b>F3</b> 200 x 200	7.00 €HT	10.50 €HT	15.75 €HT
<b>F4</b> 300 x 300	12.00 €HT	18.00 €HT	23.40 €HT

Franco de port à partir de 300 € HT

Les caractères de couleur **ROUGE** du tableau vous permettent  
de composer votre référence produit. Exemple : W003-F3-PVC

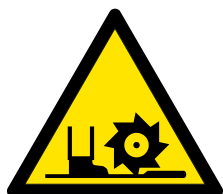

W221  
Attention aux pieds

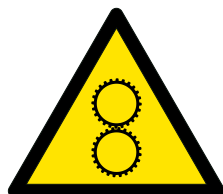

W222  
Engrenages



W223  
Attention Risque d'écrasement



W224  
Attention Risque d'écrasement



W225  
Haute température



W226  
Risque de brûlure



W227  
Espace confiné



W228



W229  
Travaux en cours



W230  
Nettoyage en cours



W231  
Attention à l'ouverture  
de la porte



W232  
Attention enfants



W233  
Attention enfants



W234  
Attention Chiens de garde



W235  
Peinture fraîche



W236  
Risque de basculement

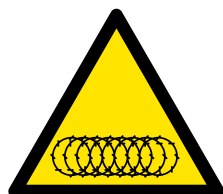

W237  
Attention aux barbelés

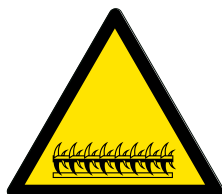

W238

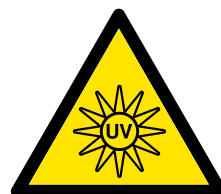

W239  
Attention rayonnement UV

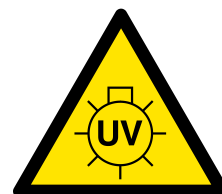

W240  
Attention lampe UV



W241  
Attention Eaux profondes

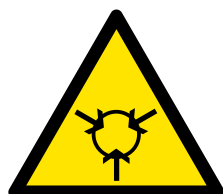

W242



W243  
Mise à la terre



W244  
Attention charge électrostatique



W245  
Emission de vibrations



## Pictogrammes - Etiquettes - Panneaux Prévention

Panneaux d'avertissement et de signalisation de risque ou de danger  
Conformes aux normes européennes pour la signalisation de sécurité  
et la santé sur les lieux de travail (Directive 92/58 du 24 juin 1992)

Formats en mm	Matières	Adh Vinyle adhésif	PVC 1,5 mm tranche blanche	Alu 2 mm tranche noire
F1	50 x 50	1.25 € HT	2.50 € HT	3.75 € HT
F2	100 x 100	2.50 € HT	5.00 € HT	7.50 € HT
F3	200 x 200	7.00 € HT	10.50 € HT	15.75 € HT
F4	300 x 300	12.00 € HT	18.00 € HT	23.40 € HT

Franco de port à partir de 300 € HT

Les caractères de couleur **ROUGE** du tableau vous permettent  
de composer votre référence produit. Exemple : W003-F3-PVC



W246



W247



W248



W249  
Risque de chute  
Dénivellement



W250  
Attention risque d'écrasement



W251  
Attention aux mains  
Rouleaux



W252  
Nettoyeur haute pression



W253

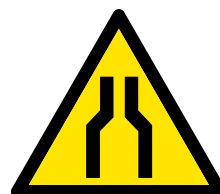

W254  
Rétrécissement de chaussée



W255  
Attention aux mains



W400  
Terre



W401  
Terre



W402  
Terre



W403  
Terre



W404  
Terre



W405  
Terre

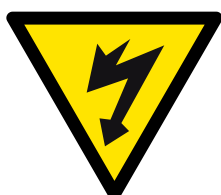

W406  
Haute tension



## Pictogrammes - Etiquettes - Panneaux Prévention

Panneaux d'avertissement et de signalisation de risque ou de danger  
Conformes aux normes européennes pour la signalisation de sécurité  
et la santé sur les lieux de travail (Directive 92/58 du 24 juin 1992)

Matières	Adh Vinyle adhésif	PVC 1,5 mm tranche blanche	Alu 2 mm tranche noire
<b>F1</b> 50 x 150	3.00 € HT	6.00 € HT	9.00 € HT
<b>F2</b> 100 x 300	5.50 € HT	10.00 € HT	15.00 € HT
<b>F3</b> 150 x 450	12.00 € HT	18.00 € HT	25.20 € HT
<b>F4</b> 200 x 600	19.00 € HT	24.70 € HT	32.11 € HT

Les caractères de couleur **ROUGE** du tableau vous permettent  
de composer votre référence produit. Exemple : W500-F3-PVC

Franco de port à partir de 300 € HT



W500



W501



W502



W503



W504



W505



W506



W507



W508



W509



W510



W511



W512



W513



W514



W515



W516



W517



## Pictogrammes - Etiquettes - Panneaux Prévention

Panneaux d'avertissement et de signalisation de risque ou de danger  
Conformes aux normes européennes pour la signalisation de sécurité  
et la santé sur les lieux de travail (Directive 92/58 du 24 juin 1992)

Matières	Adh Vinyle adhésif	PVC 1,5 mm tranche blanche	Alu 2 mm tranche noire
<b>F1</b> 50 x 150	3.00 € HT	6.00 € HT	9.00 € HT
<b>F2</b> 100 x 300	5.50 € HT	10.00 € HT	15.00 € HT
<b>F3</b> 150 x 450	12.00 € HT	18.00 € HT	25.20 € HT
<b>F4</b> 200 x 600	19.00 € HT	24.70 € HT	32.11 € HT

Franco de port à partir de 300 € HT

Les caractères de couleur **ROUGE** du tableau vous permettent  
de composer votre référence produit. Exemple : W500-F3-PVC



W518



W519



W520



W521



W522



W523



W524



W525



W526



W527



W528



W529



W530



W531



W532



W533



W534



W535





## Pictogrammes - Etiquettes - Panneaux Prévention

Panneaux d'avertissement et de signalisation de risque ou de danger  
Conformes aux normes européennes pour la signalisation de sécurité  
et la santé sur les lieux de travail (Directive 92/58 du 24 juin 1992)

Matières	Adh Vinyle adhésif	PVC 1,5 mm tranche blanche	Alu 2 mm tranche noire
<b>F1</b> 50 x 150	3.00 € HT	6.00 € HT	9.00 € HT
<b>F2</b> 100 x 300	5.50 € HT	10.00 € HT	15.00 € HT
<b>F3</b> 150 x 450	12.00 € HT	18.00 € HT	25.20 € HT
<b>F4</b> 200 x 600	19.00 € HT	24.70 € HT	32.11 € HT

Franco de port à partir de 300 € HT

Les caractères de couleur **ROUGE** du tableau vous permettent  
de composer votre référence produit. *Exemple : W500-F3-PVC*



W536



W537



W538



W539



W540



W541



W542



W543



W544



W545



W546



W547



W548



W549



W550



W551



W552



W553



## Pictogrammes - Etiquettes - Panneaux Prévention

Panneaux d'avertissement et de signalisation de risque ou de danger  
Conformes aux normes européennes pour la signalisation de sécurité  
et la santé sur les lieux de travail (Directive 92/58 du 24 juin 1992)

Matières	Adh Vinyle adhésif	PVC 1,5 mm tranche blanche	Alu 2 mm tranche noire
<b>F1</b> 50 x 150	3.00 € HT	6.00 € HT	9.00 € HT
<b>F2</b> 100 x 300	5.50 € HT	10.00 € HT	15.00 € HT
<b>F3</b> 150 x 450	12.00 € HT	18.00 € HT	25.20 € HT
<b>F4</b> 200 x 600	19.00 € HT	24.70 € HT	32.11 € HT

Franco de port à partir de 300 € HT

Les caractères de couleur **ROUGE** du tableau vous permettent  
de composer votre référence produit. Exemple : W500-F3-PVC



W554



W555



W556



W557



W558



W559



W560



W561



W562



W563



W564



W565



**LE + PREVENTI !**

*Personnalisez votre panneau : vous choisissez votre pictogramme et votre texte, nous le réalisons au même prix.*



W566



## Pictogrammes - Etiquettes - Panneaux Prévention

Panneaux d'avertissement et de signalisation de risque ou de danger  
Conformes aux normes européennes pour la signalisation de sécurité  
et la santé sur les lieux de travail (Directive 92/58 du 24 juin 1992)

Matières	Adh Vinyle adhésif	PVC 1,5 mm tranche blanche	Alu 2 mm tranche noire
<b>F1</b> 50 x 100	2.50 €HT	5.00 €HT	7.50 €HT
<b>F2</b> 75 x 150	4.00 €HT	8.00 €HT	12.00 €HT
<b>F3</b> 125 x 250	10.00 €HT	15.00 €HT	21.00 €HT
<b>F4</b> 250 x 500	15.00 €HT	21.00 €HT	27.30 €HT

Les caractères de couleur **ROUGE** du tableau vous permettent  
de composer votre référence produit. Exemple : W600-F2-PVC

Franco de port à partir de 300 € HT

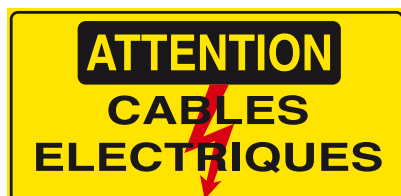

W600



W601

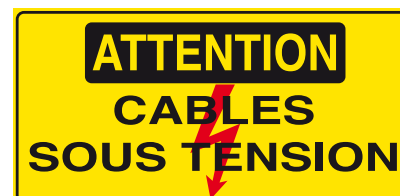

W602



W603



W604



W605



W606



W607



W608



W609



W610

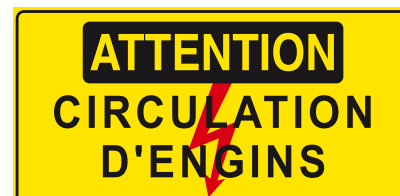

W611



W612



W613



W614



W615



W616



W617



## Pictogrammes - Etiquettes - Panneaux Prévention

Panneaux d'avertissement et de signalisation de risque ou de danger  
Conformes aux normes européennes pour la signalisation de sécurité  
et la santé sur les lieux de travail (Directive 92/58 du 24 juin 1992)

Formats en mm	Matières	Adh Vinyle adhésif	PVC 1,5 mm tranche blanche	Alu 2 mm tranche noire
F1	50 x 100	2.50 € HT	5.00 € HT	7.50 € HT
F2	75 x 150	4.00 € HT	8.00 € HT	12.00 € HT
F3	125 x 250	10.00 € HT	15.00 € HT	21.00 € HT
F4	250 x 500	15.00 € HT	21.00 € HT	27.30 € HT

Les caractères de couleur **ROUGE** du tableau vous permettent  
de composer votre référence produit. Exemple : W618-F1-PVC

Franco de port à partir de 300 € HT



W618



W619



W620



W621



W622



W623



W624



W625



W626



W627



W628

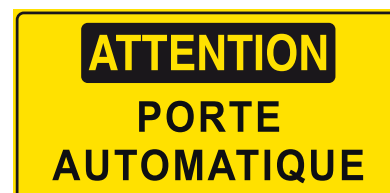

W629



W630



W631



W632



W633



W634



W635



## Pictogrammes - Etiquettes - Panneaux Prévention

Panneaux d'avertissement et de signalisation de risque ou de danger  
Conformes aux normes européennes pour la signalisation de sécurité  
et la santé sur les lieux de travail (Directive 92/58 du 24 juin 1992)

Matières		Adh Vinyle adhésif	PVC 1,5 mm tranche blanche	Alu 2 mm tranche noire
F1	50 x 100	2.50 € HT	5.00 € HT	7.50 € HT
F2	75 x 150	4.00 € HT	8.00 € HT	12.00 € HT
F3	125 x 250	10.00 € HT	15.00 € HT	21.00 € HT
F4	250 x 500	15.00 € HT	21.00 € HT	27.30 € HT

Les caractères de couleur **ROUGE** du tableau vous permettent  
de composer votre référence produit. Exemple : W636-F2-PVC

Francis de port à partir de 300 € HT

**PROTECTION  
BIOLOGIQUE**

W636

**ATTENTION  
SOURCES  
RADIOACTIVES**

W637

**ATTENTION  
MATERIEL  
RADIOACTIF**

W638

**ATTENTION  
MATIERES  
RADIOACTIVES**

W639

**ATTENTION  
MILIEU  
CORROSIF**

W640

**ATTENTION  
MATIERES  
CORROSIVES**

W641

**ATTENTION  
VAPEURS  
NOCIVES**

W642

**ATTENTION  
MILIEU CORROSIF  
PORTER DES VETEMENTS  
SPECIAUX**

W643

**ATTENTION  
PRODUIT CORROSIF  
A NE MANIPULER  
QU'AVEC DES GANTS**

W644

**ATTENTION  
LIQUIDE HAUTE  
TEMPERATURE**

W645

**ATTENTION  
MATIERE HAUTE  
TEMPERATURE**

W646

**ATTENTION  
VAPEUR HAUTE  
PRESSION**

W647

**ATTENTION  
PURGE DE  
VAPEUR**

W648

**ATTENTION  
AIR  
COMPRIE**

W649



**LE + PREVENTI !**

*Personnalisez votre panneau :  
vous choisissez votre texte,  
nous le réalisons au même prix*

**VOTRE  
TEXTE**

W650

**ATTENTION**

**VOTRE  
TEXTE**

W651



## Pictogrammes - Etiquettes - Panneaux Prévention

Panneaux d'avertissement et de signalisation de risque ou de danger  
Conformes aux normes européennes pour la signalisation de sécurité  
et la santé sur les lieux de travail (Directive 92/58 du 24 juin 1992)

Formats en mm	Matières	Adh Vinyle adhésif	PVC 1,5 mm tranche blanche	Alu 2 mm tranche noire
F1 50 x 75		2.50 € HT	5.00 € HT	7.50 € HT
F2 100 x 150		4.00 € HT	8.00 € HT	12.00 € HT
F3 150 x 225		10.00 € HT	15.00 € HT	21.00 € HT
F4 200 x 300		15.00 € HT	21.00 € HT	27.30 € HT

Les caractères de couleur **ROUGE** du tableau vous permettent  
de composer votre référence produit. Exemple : W700-F3-Alu

Franco de port à partir de 300 € HT



W700



W701

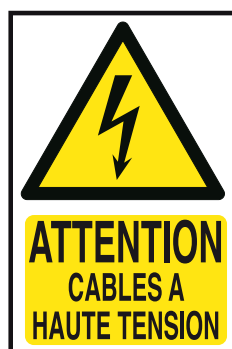

W702



W703



W704



W705



W706



W707



W708



W709

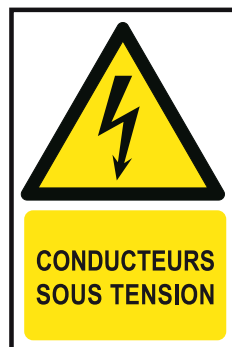

W710



W711



W712



W713

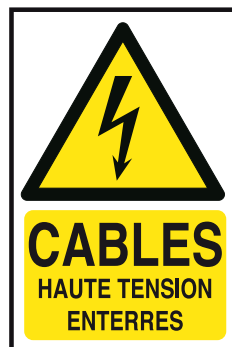

W714



W715





## Pictogrammes - Etiquettes - Panneaux Prévention

Panneaux d'avertissement et de signalisation de risque ou de danger  
Conformes aux normes européennes pour la signalisation de sécurité  
et la santé sur les lieux de travail (Directive 92/58 du 24 juin 1992)

Formats en mm	Matières	Adh Vinyle adhésif	PVC 1,5 mm tranche blanche	Alu 2 mm tranche noire
F1	50 x 75	2.50 € HT	5.00 € HT	7.50 € HT
F2	100 x 150	4.00 € HT	8.00 € HT	12.00 € HT
F3	150 x 225	10.00 € HT	15.00 € HT	21.00 € HT
F4	200 x 300	15.00 € HT	21.00 € HT	27.30 € HT

Les caractères de couleur **ROUGE** du tableau vous permettent  
de composer votre référence produit. Exemple : W716-F11-Alu

Franco de port à partir de 300 € HT



W716



W717



W718



W719



W720



W721



W722



W723



W724



W725



W726



W727



W728



W729



W730



W731



## Pictogrammes - Etiquettes - Panneaux Prévention

Panneaux d'avertissement et de signalisation de risque ou de danger  
Conformes aux normes européennes pour la signalisation de sécurité  
et la santé sur les lieux de travail (Directive 92/58 du 24 juin 1992)

Matières	Adh	PVC	Alu	
Formats en mm	Vinyle adhésif	1,5 mm tranche blanche	2 mm tranche noire	
<b>F1</b>	50 x 75	2.50 €HT	5.00 €HT	7.50 €HT
<b>F2</b>	100 x 150	4.00 €HT	8.00 €HT	12.00 €HT
<b>F3</b>	150 x 225	10.00 €HT	15.00 €HT	21.00 €HT
<b>F4</b>	200 x 300	15.00 €HT	21.00 €HT	27.30 €HT

Franco de port à partir de 300 € HT

Les caractères de couleur **ROUGE** du tableau vous permettent  
de composer votre référence produit. Exemple : W732-F4-Alu



W732



W733



W734



W735



W736



W737



W738



W739



W740



W741



W742



W743



W744



W745



W746



W747



## Pictogrammes - Etiquettes - Panneaux Prévention

Panneaux d'avertissement et de signalisation de risque ou de danger  
Conformes aux normes européennes pour la signalisation de sécurité  
et la santé sur les lieux de travail (Directive 92/58 du 24 juin 1992)

Formats en mm	Matières	Adh Vinyle adhésif	PVC 1,5 mm tranche blanche	Alu 2 mm tranche noire
F1	50 x 75	2.50 €HT	5.00 €HT	7.50 €HT
F2	100 x 150	4.00 €HT	8.00 €HT	12.00 €HT
F3	150 x 225	10.00 €HT	15.00 €HT	21.00 €HT
F4	200 x 300	15.00 €HT	21.00 €HT	27.30 €HT

Les caractères de couleur **ROUGE** du tableau vous permettent  
de composer votre référence produit. Exemple : W748-F3-Alu

Franco de port à partir de 300 € HT



W748



W749



W750

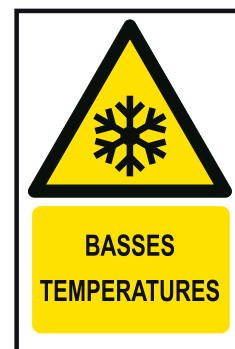

W751



W752



W753



W754



W755



W756



W757



W758



W759



W760



W761



W762



W763



## Pictogrammes - Etiquettes - Panneaux Prévention

Panneaux d'avertissement et de signalisation de risque ou de danger  
Conformes aux normes européennes pour la signalisation de sécurité  
et la santé sur les lieux de travail (Directive 92/58 du 24 juin 1992)

Formats en mm	Matières	Adh Vinyle adhésif	PVC 1,5 mm tranche blanche	Alu 2 mm tranche noire
F1	50 x 75	2.50 € HT	5.00 € HT	7.50 € HT
F2	100 x 150	4.00 € HT	8.00 € HT	12.00 € HT
F3	150 x 225	10.00 € HT	15.00 € HT	21.00 € HT
F4	200 x 300	15.00 € HT	21.00 € HT	27.30 € HT

Franco de port à partir de 300 € HT.

Les caractères de couleur **ROUGE** du tableau vous permettent  
de composer votre référence produit. Exemple : W764-F3-Alu



W764



W765



W766



**LE + PREVENTI !**

*Personnalisez votre panneau : vous choisissez votre pictogramme  
et votre texte, nous le réalisons au même prix.*



W767



## Pictogrammes - Etiquettes - Panneaux Prévention

Panneaux d'avertissement et de signalisation de risque ou de danger  
Conformes aux normes européennes pour la signalisation de sécurité  
et la santé sur les lieux de travail (Directive 92/58 du 24 juin 1992)

Matières	Adh Vynyle adhésif	PVC 1,5 mm tranche blanche	Alu 2 mm tranche noire
<b>F1</b> 50 x 150	3.00 € HT	6.00 € HT	9.00 € HT
<b>F2</b> 100 x 300	5.50 € HT	10.00 € HT	15.00 € HT
<b>F3</b> 150 x 450	12.00 € HT	18.00 € HT	25.20 € HT
<b>F4</b> 200 x 600	19.00 € HT	24.70 € HT	32.11 € HT

Les caractères de couleur **ROUGE** du tableau vous permettent  
de composer votre référence produit. Exemple : W900-F1-Adh

Franco de port à partir de 300 € HT

**VANNE  
GAZ**

W900

**VANNE  
BARRAGE GAZ**

W901

**COUPURE GAZ**

W902

**GAZ  
INFLAMMABLES**

W903

**MATIERES  
INFLAMMABLES**

W904

**LIQUIDES  
INFLAMMABLES**

W905

**FLAMME NUE  
INTERDITE**

W906

**DANGER  
D'EXPLOSION**

W907

**DANGER  
D'INCENDIE**

W908

**STOCKAGE  
MAZOUT**

W909

**STOCKAGE  
CARBURANT**

W910

**APPAREILS  
SOUS PRESSION**

W911

**MARCHE AUTOMATIQUE  
AVANT TOUT TRAVAIL  
COUPER LE COURANT**

W912

**ACCES RESERVE  
AU PERSONNEL  
HABILITE**

W913

**PIECES NUES  
SOUS TENSION**

W914

**EN REPARATION**

W915

**AVANT D'OUVRIRE  
COUPER  
LE COURANT**

W916

**HAUTE  
TENSION**

W917

**CABLES  
ELECTRIQUES  
ENTERRES**

W918

**CONDUCTEURS  
SOUS TENSION**

W919

**EN SERVICE**

W920



## Pictogrammes - Etiquettes - Panneaux Prévention

Panneaux d'avertissement et de signalisation de risque ou de danger  
Conformes aux normes européennes pour la signalisation de sécurité  
et la santé sur les lieux de travail (Directive 92/58 du 24 juin 1992)

Formats en mm	Matières	Adh Vynyle adhésif	PVC 1,5 mm tranche blanche	Alu 2 mm tranche noire
<b>F1</b> 50 x 150		3.00 € HT	6.00 € HT	9.00 € HT
<b>F2</b> 100 x 300		5.50 € HT	10.00 € HT	15.00 € HT
<b>F3</b> 150 x 450		12.00 € HT	18.00 € HT	25.20 € HT
<b>F4</b> 200 x 600		19.00 € HT	24.70 € HT	32.11 € HT

Les caractères de couleur **ROUGE** du tableau vous permettent  
de composer votre référence produit. Exemple : W921 -F4-Adh

Franco de port à partir de 300 € HT

**ACCES RESERVE  
EXCLUSIVEMENT  
AU PERSONNEL  
D'ELECTRICITE DE FRANCE**

W921

**ACCES RESERVE  
EXCLUSIVEMENT  
AU PERSONNEL  
DU SERVICE ELECTRIQUE**

W922

**ACCES RESERVE  
EXCLUSIVEMENT  
AU PERSONNEL AUTORISE**

W923

**VIDES**

W924

**PLEINES**

W925

**OXYGENE**

W926

**ACETYLENE**

W927

**HYDROGENE**

W928

**PROPANE**

W929

**BUTANE**

W930

**BENZENE**

W931

**SOLVANT**

W932

**CHLORE**

W933

**AMMONIAC**

W934

**SOUDE**

W935

**ACIDE**

W936

**JAVEL**

W937

**VAPEUR**

W938

**AZOTE**

W939

**ARGON**

W940

**HELIUM**

W941





## Pictogrammes - Etiquettes - Panneaux Prévention

Panneaux d'avertissement et de signalisation de risque ou de danger  
Conformes aux normes européennes pour la signalisation de sécurité  
et la santé sur les lieux de travail (Directive 92/58 du 24 juin 1992)

Formats en mm	Matières	Adh Vinyle adhésif	PVC 1,5 mm tranche blanche	Alu 2 mm tranche noire
F1	50 x 150	3.00 € HT	6.00 € HT	9.00 € HT
F2	100 x 300	5.50 € HT	10.00 € HT	15.00 € HT
F3	150 x 450	12.00 € HT	18.00 € HT	25.20 € HT
F4	200 x 600	19.00 € HT	24.70 € HT	32.11 € HT

Les caractères de couleur **ROUGE** du tableau vous permettent  
de composer votre référence produit. Exemple : W942-F3-PVC

Franco de port à partir de 300 € HT



W942



W943



W944



W945



W946



W947



W948



W949



W950



**LE + PREVENTI !**

*Personnalisez votre panneau : vous choisissez votre texte,  
nous le réalisons au même prix.*



W951



## Panneaux d'obligation

### Caractéristiques :

- Forme ronde ;
- Pictogramme blanc sur fond bleu (le bleu doit recouvrir au moins 50 % de la surface du panneau).

### Exemple de panneaux à utiliser :



M001  
Obligation Signal général



M002  
Consulter le manuel/la notice d'instruction



M003  
Serre-tête antibruit obligatoire



M004  
Lunettes de protection obligatoires

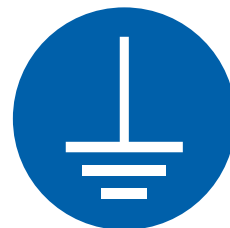

M005  
Mise à la terre obligatoire



### CONSEIL

### Comment choisir son format de panneau ?

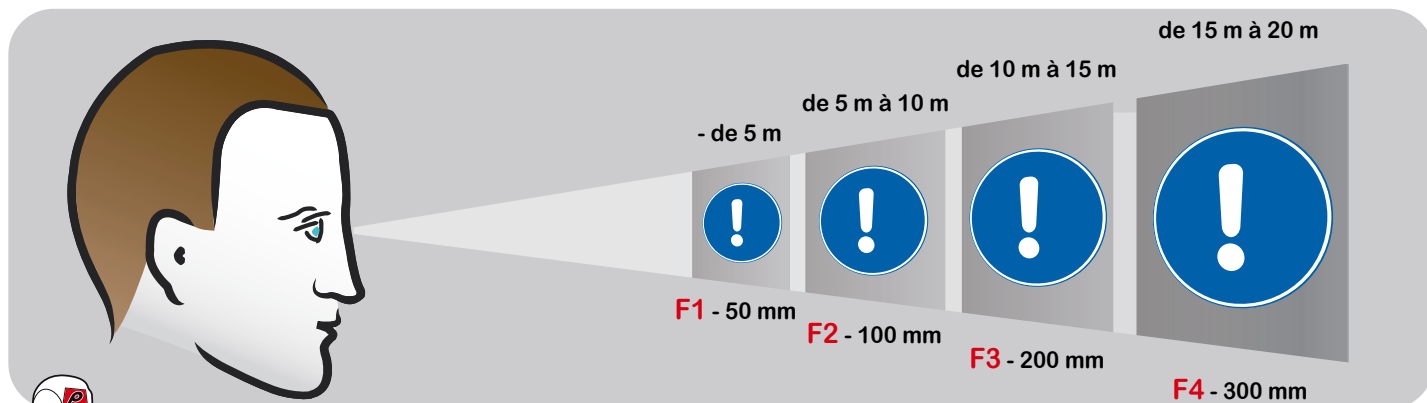

### CONSEIL

### Comment choisir sa matière ?

#### Adh

#### Adhésif

Sur surface lisse. Intérieur ou extérieur.  
Très bonne résistance aux UV, graisses et solvants  
Très bonne adhérence finale offrant une excellente tenue sur une grande variété de supports.

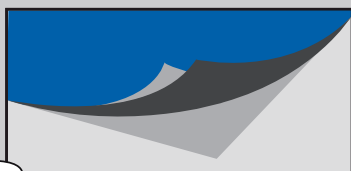

#### PVC Plaques PVC 1.5 mm

Sur surface lisse. Intérieur.  
Plaque rigide à structure allégée.  
Classée au feu M1  
Stabilité au vieillissement.

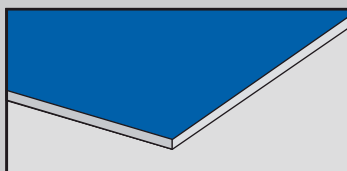

#### Alu Plaques ALU 2 mm

Sur toutes surfaces. Extérieur.  
Rigidité équivalente à celle d'une plaque d'aluminium pleine de 2,7 mm  
Très résistante aux chocs et aux intempéries.  
Résistance de - 50°C à + 90°C  
Classée au feu M1

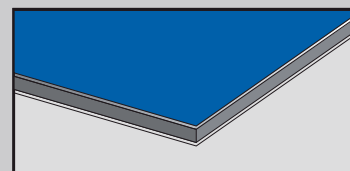

### CONSEIL

### Comment composer sa référence pour commander ?

La référence complète se compose d'une lettre et 3 chiffres pour la référence définissant le motif du panneau suivis de son format (F1, F2, F3 ou F4) et enfin de sa matière (Adh, PVC ou Alu).

Exemple : **M001-F4-Alu** pour un panneau **Obligation signal général** au Format 4 (300 mm de largeur) en **Alu**.



## Pictogrammes - Etiquettes - Panneaux Obligation



La **nouvelle norme ISO 7010** a été mise à jour en avril 2013.  
Certains panneaux sont remplacés par une version plus universelle.  
Preventimark vous garantit des panneaux conformes à la nouvelle  
législation en vigueur.

Matières	Adh Vinyle adhésif	PVC 1,5 mm tranche blanche	Alu 2 mm tranche noire
F1 Ø 50	1.25 € HT	2.50 € HT	3.75 € HT
F2 Ø 100	2.50 € HT	5.00 € HT	7.50 € HT
F3 Ø 200	7.00 € HT	10.50 € HT	15.75 € HT
F4 Ø 300	12.00 € HT	18.00 € HT	23.40 € HT

Les caractères de couleur **ROUGE** du tableau vous permettent  
de composer votre référence produit. Exemple : M003-F3-Alu

Francis de port à partir de 300 € HT



**M001**  
Obligation Signal général



**M002**  
Consulter le manuel/la notice  
d'instruction



**M003**  
Serre-tête antibruit obligatoire



**M004**  
Lunettes de protection obligatoires



**M005**  
Mise à la terre obligatoire

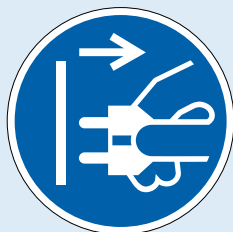

**M006**  
Débrancher la prise d'alimentation  
du secteur



**M007**  
Lunettes de protection opaques  
obligatoires



**M008**  
Chaussures de sécurité  
obligatoires



**M009**  
Gants de protection obligatoires



**M010**  
Vêtements de protection  
obligatoires



**M011**  
Lavage des mains obligatoire



**M012**  
Utiliser la main courante



**M013**  
Visière de protection obligatoire



**M014**  
Casque de protection obligatoire



**M015**  
Gilet de sécurité haute  
visibilité obligatoire



**M016**  
Masque obligatoire



**M017**  
Protection des voies respiratoires  
obligatoire



**M018**  
Harnais de sécurité obligatoire



**M019**  
Masque de soudage obligatoire

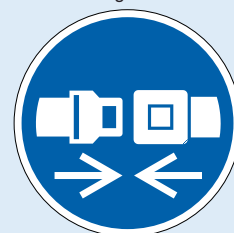

**M020**  
Attacher la ceinture de  
sécurité



**M021**  
Débrancher avant d'effectuer une  
activité de maintenance ou une  
réparation



**M022**  
Utiliser une crème de protection



**M023**  
Utiliser la passerelle



**M024**  
Utiliser le passage



**M025**  
Protection opaque des yeux  
obligatoire pour les enfants  
en bas âge



## Pictogrammes - Etiquettes - Panneaux Obligation



La **nouvelle norme ISO 7010** a été mise à jour en avril 2013.  
Certains panneaux sont remplacés par une version plus universelle.  
Preventimark vous garantit des panneaux conformes à la nouvelle  
législation en vigueur.

Matières	Adh Vinyle adhésif	PVC 1,5 mm tranche blanche	Alu 2 mm tranche noire
F1 Ø 50	1.25 € HT	2.50 € HT	3.75 € HT
F2 Ø 100	2.50 € HT	5.00 € HT	7.50 € HT
F3 Ø 200	7.00 € HT	10.50 € HT	15.75 € HT
F4 Ø 300	12.00 € HT	18.00 € HT	23.40 € HT

Les caractères de couleur **ROUGE** du tableau vous permettent  
de composer votre référence produit. Exemple : M003-F3-Alu

Franco de port à partir de 300 € HT



**M026**  
Tablier de procection obligatoire



**M150**  
Surchaussure obligatoire



**M151**  
Suivre la flèche



**M152**  
Gaz sous pression

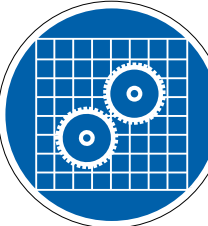

**M153**  
Utiliser les grilles  
de protections



**M154**  
Utilisation de  
cadenas obligatoire



**M155**  
Utilisation d'oxymètre  
obligatoire



**M156**  
Consultez le guide  
d'information



**M157**  
Enregistrement personnalisé  
obligatoire

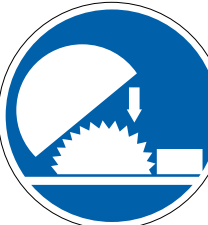

**M158**  
Fermez la scie



**M159**  
Utilisez les poubelles



**M160**  
Gilet de sauvetage  
obligatoire



**M161**  
Port du béret obligatoire



**M162**  
Blouse coton obligatoire



**M163**  
Charlotte



**M164**  
Chaînes obligatoires  
pour bouteille de gaz



**M165**  
Port d'une blouse obligatoire



**M166**  
Signalement sonore obligatoire



**M167**  
Appareil filtrant obligatoire

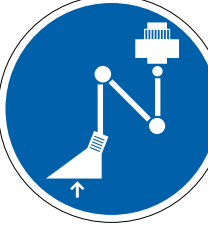

**M168**  
Système d'aspiration  
obligatoire



**M169**  
Cale obligatoire



**M170**  
Emplacement fumeur



**M171**  
Eteignez votre mobile



**M172**  
Piste cyclable



**M173**  
Surveillance vidéo



## Pictogrammes - Etiquettes - Panneaux Obligation

### Panneaux d'obligation

Conformes aux normes européennes pour la signalisation de sécurité et la santé sur les lieux de travail (Directive 92/58 du 24 juin 1992)

Matières	Adh Vinyle adhésif	PVC 1,5 mm tranche blanche	Alu 2 mm tranche noire
<b>F1</b> Ø 50	1.25 € HT	2.50 € HT	3.75 € HT
<b>F2</b> Ø 100	2.50 € HT	5.00 € HT	7.50 € HT
<b>F3</b> Ø 200	7.00 € HT	10.50 € HT	15.75 € HT
<b>F4</b> Ø 300	12.00 € HT	18.00 € HT	23.40 € HT

Francis de part à partir de 300 € HT

Les caractères de couleur **ROUGE** du tableau vous permettent de composer votre référence produit. Exemple : M174-F4-Alu



**M174**  
Position pour le dos



**M175**  
Utilisation de cadenas obligatoire



**M176**  
Gants conducteurs obligatoires



**M177**  
Utilisation des poubelles obligatoire



**M178**  
Tenez votre chien en laisse

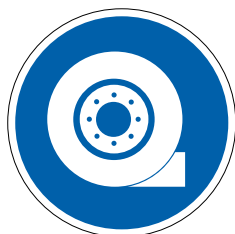

**M179**  
Cale obligatoire



**M180**  
Allumez votre mobile



**M181**  
Port du casque obligatoire



**M182**  
Port du casque et lunettes de protection obligatoires



**M183**  
Port du casque, lunettes et protection auditive obligatoire



**M184**  
Port du casque et protection auditive obligatoire



**M185**  
Protection auditive obligatoire



**M186**  
Protection auditive obligatoire



**M187**  
Lunettes de protection obligatoires



**M188**  
Visière de protection obligatoire



**M189**  
Visière de protection obligatoire



**M190**  
Masque de soudure obligatoire



**M191**  
Protection des voies respiratoires obligatoire



**M192**  
Casque et protection des voies respiratoires obligatoire



**M193**  
Protection des voies respiratoires obligatoire



**M194**  
Protection des voies respiratoires obligatoire



**M195**  
Protection des voies respiratoires obligatoire



**M196**  
Protection des voies respiratoires obligatoire



**M197**  
Harnais de sécurité obligatoire



**M198**  
Ceinture de sécurité obligatoire





## Pictogrammes - Etiquettes - Panneaux Obligation

### Panneaux d'obligation

Conformes aux normes européennes pour la signalisation de sécurité et la santé sur les lieux de travail (Directive 92/58 du 24 juin 1992)

Matières	Adh	PVC	Alu
Formats en mm	Vinyle adhésif	1,5 mm tranche blanche	2 mm tranche noire
F1 Ø 50	1.25 € HT	2.50 € HT	3.75 € HT
F2 Ø 100	2.50 € HT	5.00 € HT	7.50 € HT
F3 Ø 200	7.00 € HT	10.50 € HT	15.75 € HT
F4 Ø 300	12.00 € HT	18.00 € HT	23.40 € HT

Franco de port à partir de 300 € HT

Les caractères de couleur **ROUGE** du tableau vous permettent de composer votre référence produit. Exemple : M200-F4-Alu



**M199**  
Gilet de sécurité haute visibilité obligatoire



**M200**  
Vêtement de protection obligatoire



**M201**  
Vêtement de protection obligatoire



**M202**  
Gants et chaussures de protection obligatoires



**M203**  
Chaussures de sécurité obligatoires



**M204**  
Chaussures à semelles conductrices obligatoires



**M205**  
Port du bonnet obligatoire



**M206**  
Port du bonnet obligatoire



**M207**  
Lavage des mains obligatoire



**M208**  
Chaîne obligatoire pour bouteilles de gaz



**M209**  
Utilisation de cadenas obligatoire



**M210**  
Utilisation de cadenas obligatoire

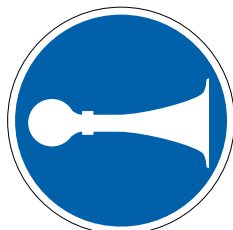

**M211**  
Utilisation de l'avertisseur obligatoire

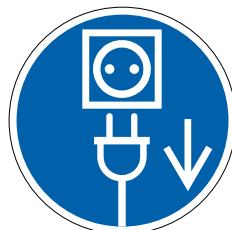

**M212**  
Débrancher la prise du secteur



**M213**  
Couper l'alimentation avant travaux de maintenance



**M214**  
Port de sur-chaussures obligatoire



**M215**  
Déverrouiller en tournant la poignée puis tirer

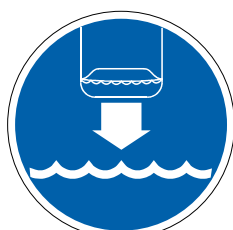

**M216**  
Baisser le radeau de sauvetage à l'eau



**M217**  
Baisser le radeau de sauvetage à l'eau



**M218**  
Relâcher la poignée



**M219**  
Casquette anti-heurt obligatoire



**M220**  
Casquette anti-heurt obligatoire



**M221**  
Masque de protection oculaire obligatoire



**M222**  
Masque de protection oculaire obligatoire



**M223**  
Combinaison de protection obligatoire





## Pictogrammes - Etiquettes - Panneaux Obligation

### Panneaux d'obligation

Conformes aux normes européennes pour la signalisation de sécurité et la santé sur les lieux de travail (Directive 92/58 du 24 juin 1992)

Matières	Adh Vinyle adhésif	PVC 1,5 mm tranche blanche	Alu 2 mm tranche noire
F1 Ø 50	1.25 € HT	2.50 € HT	3.75 € HT
F2 Ø 100	2.50 € HT	5.00 € HT	7.50 € HT
F3 Ø 200	7.00 € HT	10.50 € HT	15.75 € HT
F4 Ø 300	12.00 € HT	18.00 € HT	23.40 € HT

Franco de port à partir de 300 € HT

Les caractères de couleur **ROUGE** du tableau vous permettent de composer votre référence produit. Exemple : M224-F4-Alu



**M224**  
Gilet de sauvetage obligatoire



**M225**  
Passage des piétons obligatoire



**M226**  
Passage des piétons obligatoire



**M227**  
Utilisation de la poubelle obligatoire



**M228**  
Utilisation de la poubelle obligatoire



**M 229**  
Couper l'alimentation avant travaux de maintenance



**M230**  
Respecter la position

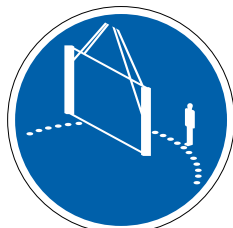

**M231**  
Respecter le périmètre de sécurité



**M232**  
Arrimage des panneaux obligatoire



**M233**



**M234**  
Consulter le manuel



**M235**  
Lire le manuel d'information



**M236**  
Utilisation de l'avertisseur obligatoire



**M237**  
Cale obligatoire



**M238**  
Ceinture de sécurité obligatoire



**M239**  
Tenir la rampe



**M240**



**M241**  
Torche électrique obligatoire



**M242**  
Allumez votre torche électrique



**M243**  
Point d'ancrage obligatoire

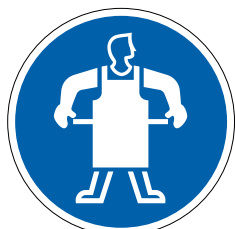

**M244**  
Tablier de protection obligatoire



**M245**  
Manches longues obligatoires



**M246**



**M247**  
Silence obligatoire



## Pictogrammes - Etiquettes - Panneaux Obligation

### Panneaux d'obligation

Conformes aux normes européennes pour la signalisation de sécurité et la santé sur les lieux de travail (Directive 92/58 du 24 juin 1992)

Matières	Adh Vinyle adhésif	PVC 1,5 mm tranche blanche	Alu 2 mm tranche noire
F1 Ø 50	1.25 € HT	2.50 € HT	3.75 € HT
F2 Ø 100	2.50 € HT	5.00 € HT	7.50 € HT
F3 Ø 200	7.00 € HT	10.50 € HT	15.75 € HT
F4 Ø 300	12.00 € HT	18.00 € HT	23.40 € HT

Les caractères de couleur **ROUGE** du tableau vous permettent de composer votre référence produit. Exemple : M300-F2-PVC

Franco de port à partir de 300 € HT



M300



M301



M302



M303



M304



M305



M306



M307



M308



M309



M310



M311



M312



M313



M314



M315



M316



M317



**LE + PREVENTI !**

*Personnalisez votre panneau :  
vous choisissez votre texte,  
nous le réalisons au même prix.*



M319



## Pictogrammes - Etiquettes - Panneaux Obligation

### Panneaux d'obligation

Conformes aux normes européennes pour la signalisation de sécurité et la santé sur les lieux de travail (Directive 92/58 du 24 juin 1992)

Matières		Adh Vinyle adhésif	PVC 1,5 mm tranche blanche	Alu 2 mm tranche noire
<b>F1</b>	<b>50 x 150</b>	3.00 € HT	6.00 € HT	9.00 € HT
<b>F2</b>	<b>100 x 300</b>	5.50 € HT	10.00 € HT	15.00 € HT
<b>F3</b>	<b>150 x 450</b>	12.00 € HT	18.00 € HT	25.20 € HT
<b>F4</b>	<b>200 x 600</b>	19.00 € HT	24.70 € HT	32.11 € HT

Les caractères de couleur **ROUGE** du tableau vous permettent de composer votre référence produit. Exemple : M500-F4-PVC

Franco de port à partir de 300 € HT



M500



M501



M502



M503



M504



M505



M506



M507



M508



M509



M510



M511



M512



M513



M514



M515



M516



M517



## Pictogrammes - Etiquettes - Panneaux Obligation

### Panneaux d'obligation

Conformes aux normes européennes pour la signalisation de sécurité et la santé sur les lieux de travail (Directive 92/58 du 24 juin 1992)

Matières	Adh Vinyle adhésif	PVC 1,5 mm tranche blanche	Alu 2 mm tranche noire
<b>F1</b> 50 x 150	3.00 € HT	6.00 € HT	9.00 € HT
<b>F2</b> 100 x 300	5.50 € HT	10.00 € HT	15.00 € HT
<b>F3</b> 150 x 450	12.00 € HT	18.00 € HT	25.20 € HT
<b>F4</b> 200 x 600	19.00 € HT	24.70 € HT	32.11 € HT

Les caractères de couleur **ROUGE** du tableau vous permettent de composer votre référence produit. Exemple : M518-F1-PVC

Franco de port à partir de 300 € HT



M518



M519



M520



M521



M522



M523



M524



M525

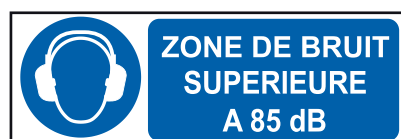

M526



M527



M528



M529



M530



M531



**Personnalisez votre panneau : vous choisissez votre pictogramme et votre texte, nous le réalisons au même prix.**



M532



## Pictogrammes - Etiquettes - Panneaux Obligation

### Panneaux d'obligation

Conformes aux normes européennes pour la signalisation de sécurité et la santé sur les lieux de travail (Directive 92/58 du 24 juin 1992)

Formats en mm	Matières	Adh Vinyle adhésif	PVC 1,5 mm tranche blanche	Alu 2 mm tranche noire
F1	50 x 150	3.00 € HT	6.00 € HT	9.00 € HT
F2	100 x 300	5.50 € HT	10.00 € HT	15.00 € HT
F3	150 x 450	12.00 € HT	18.00 € HT	25.20 € HT
F4	200 x 600	19.00 € HT	24.70 € HT	32.11 € HT

Les caractères de couleur **ROUGE** du tableau vous permettent de composer votre référence produit. Exemple : M650-F4-PVC

Franco de port à partir de 300 € HT

**AU-DELA  
DE CETTE LIMITE**

M650

**AU-DELA DE CETTE LIMITE  
PROTECTION  
OBLIGATOIRE**

M651

**PORT DES E.P.I  
OBLIGATOIRE**

M652

**ZONE A CONSIGNES  
DE SECURITE  
PARTICULIERES**

M653

**PERMIS DE TRAVAIL  
OBLIGATOIRE**

M654



**LE + PREVENTI !**

*Personnalisez votre panneau :  
vous choisissez votre texte,  
nous le réalisons au même prix.*

**VOTRE  
TEXTE**

M655

## Pictogrammes - Etiquettes - Panneaux Obligation

### Panneaux d'obligation

Conformes aux normes européennes pour la signalisation de sécurité et la santé sur les lieux de travail (Directive 92/58 du 24 juin 1992)

Formats en mm	Matières	Adh Vinyle adhésif	PVC 1,5 mm tranche blanche	Alu 2 mm tranche noire
F1	50 x 100	2.50 € HT	5.00 € HT	7.50 € HT
F2	75 x 150	4.00 € HT	8.00 € HT	12.00 € HT
F3	125 x 250	10.00 € HT	15.00 € HT	21.00 € HT
F4	250 x 500	15.00 € HT	21.00 € HT	27.30 € HT

Les caractères de couleur **ROUGE** du tableau vous permettent de composer votre référence produit. Exemple : M650-F4-PVC

Franco de port à partir de 300 € HT



**LE + PREVENTI !**

*Personnalisez votre panneau :  
vous choisissez votre texte,  
nous le réalisons au même prix*

**VOTRE  
TEXTE**

M700



## Pictogrammes - Etiquettes - Panneaux Obligation



La nouvelle norme ISO 7010 a été mise à jour en avril 2013.  
Certains panneaux sont remplacés par une version plus universelle.  
Preventimark vous garantit des panneaux conformes à la nouvelle législation en vigueur.

Matières		Adh Vinyle adhésif	PVC 1,5 mm tranche blanche	Alu 2 mm tranche noire
F1	50 x 75	2.50 € HT	5.00 € HT	7.50 € HT
F2	100 x 150	4.00 € HT	8.00 € HT	12.00 € HT
F3	150 x 225	10.00 € HT	15.00 € HT	21.00 € HT
F4	200 x 300	15.00 € HT	21.00 € HT	27.30 € HT

Les caractères de couleur **ROUGE** du tableau vous permettent de composer votre référence produit.  
Exemple : M800-F3-Adh

Francis de port à partir de 300 € HT



M800



M801



M802



M803



M804



M805



M806



M807



M808



M809



M810



M811

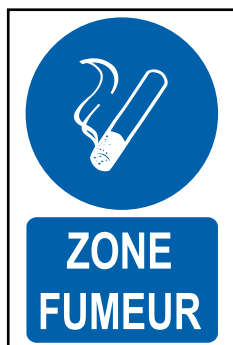

M812

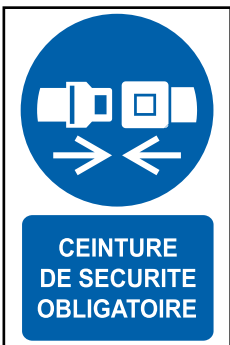

M813



M814



M815





## Panneaux d'interdiction

### Caractéristiques :

- Forme ronde ;
- Pictogramme noir sur fond blanc, bordure et bande (descendant de gauche à droite à 45° par rapport à l'horizontale), rouge (le rouge doit recouvrir au moins 35 % de la surface du panneau).

### Exemple de panneaux à utiliser :



P001  
Interdiction Signal général



P002  
Interdiction de fumer



P003  
Flammes nues interdites  
Feu et source d'allumage  
non protégée interdits  
Interdiction de fumer



P004  
Interdit aux piétons



P005  
Eau non potable



### CONSEIL

## Comment choisir son format de panneau ?

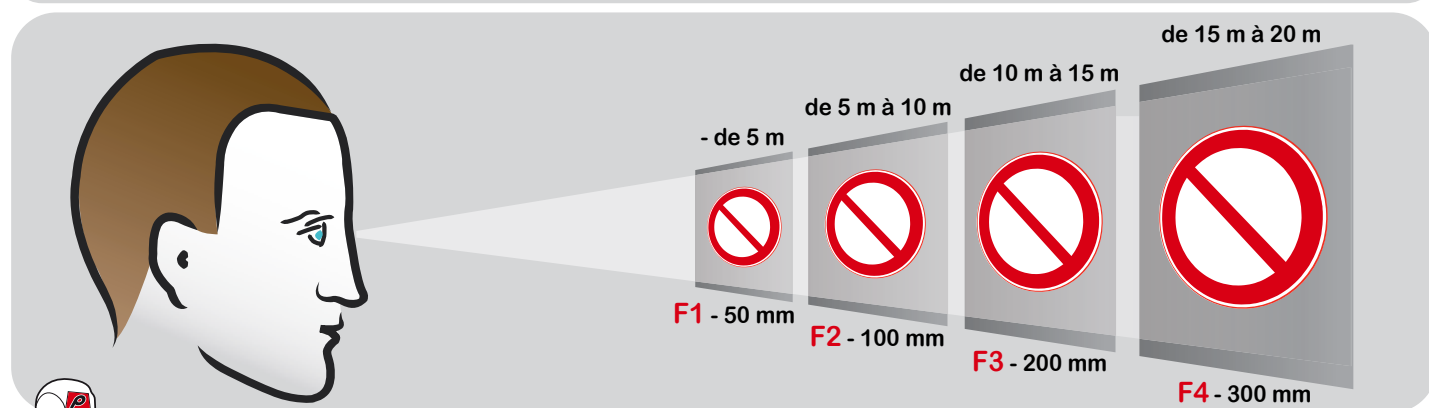

### CONSEIL

## Comment choisir sa matière ?

### Adh

#### Adhésif

Sur surface lisse. Intérieur ou extérieur.  
Très bonne résistance aux UV, graisses et solvants  
Très bonne adhérence finale offrant une excellente tenue sur une grande variété de supports.

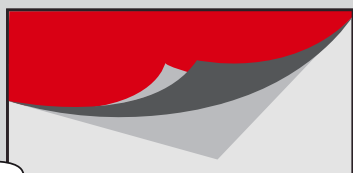

### PVC Plaques PVC 1.5 mm

Sur surface lisse. Intérieur.  
Plaque rigide à structure allégée.  
Classée au feu M1  
Stabilité au vieillissement.

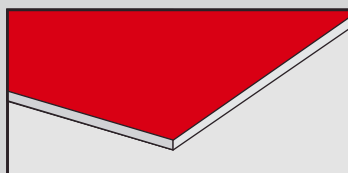

### Alu Plaques ALU 2 mm

Sur toutes surfaces. Extérieur.  
Rigidité équivalente à celle d'une plaque d'aluminium pleine de 2,7 mm  
Très résistante aux chocs et aux intempéries.  
Résistance de - 50°C à + 90°C  
Classée au feu M1

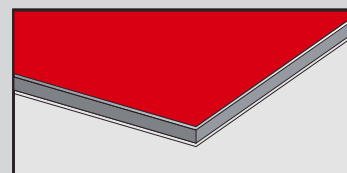

### CONSEIL

## Comment composer sa référence pour commander ?

La référence complète se compose d'une lettre et 3 chiffres pour la référence définissant le motif du panneau suivis de son format (F1, F2, F3 ou F4) et enfin de sa matière (Adh, PVC ou Alu).

Exemple : **P004-F2-Adh** pour un panneau **Interdit aux piétons** au **Format 2** (100 mm de largeur) en **Adhésif**.



## Pictogrammes - Etiquettes - Panneaux Interdiction



La nouvelle norme ISO 7010 a été mise à jour en avril 2013.  
Certains panneaux sont remplacés par une version plus universelle.  
Preventimark vous garanti des panneaux conformes à la nouvelle  
législation en vigueur.

Matières	Adh Vinyle adhésif	PVC 1,5 mm tranche blanche	Alu 2 mm tranche noire
<b>F1</b> Ø 50	1.25 €HT	2.50 €HT	3.75 €HT
<b>F2</b> Ø 100	2.50 €HT	5.00 €HT	7.50 €HT
<b>F3</b> Ø 200	7.00 €HT	10.50 €HT	15.75 €HT
<b>F4</b> Ø 300	12.00 €HT	18.00 €HT	23.40 €HT

Les caractères de couleur ROUGE du tableau vous permettent  
de composer votre référence produit. Exemple : P028-F1-PVC

Franco de port à partir de 300 € HT



P001  
Interdiction Signal général



P002  
Interdiction de fumer



P003  
Flammes nues interdites - Feu et  
source d'allumage non protégée  
interdits



P004  
Interdit aux piétons



P005  
Eau non potable



P006  
Interdit aux chariots élévateurs à  
fourche et autres véhicules  
industriels

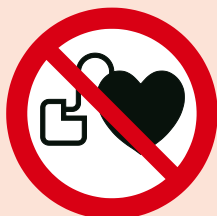

P007  
Entrée interdite aux porteurs d'un  
stimulateur cardiaque



P008  
Articles métalliques ou montres  
interdits



P010  
Interdiction de toucher



P011  
Interdiction d'éteindre  
avec de l'eau



P012  
Charges lourdes interdites



P013  
Interdiction d'activer des  
téléphones mobiles



P014  
Entrée interdite aux porteurs  
d'implants métalliques



P015  
Ne pas mettre les mains



P017  
Interdiction de pousser



P018  
Interdiction de s'asseoir



P019  
Interdiction de marcher sur  
la surface



P020  
Interdiction d'utiliser l'ascenseur  
en cas d'incendie



P021  
Interdit aux chiens



P022  
Interdiction de manger  
ou de boire

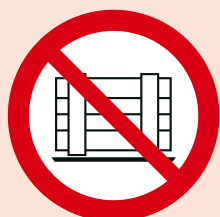

P023  
Ne pas obstruer



P024  
Ne pas marcher ou stationner  
à cet endroit



P025  
Ne pas utiliser un échafaudage  
incomplet



P026  
Ne pas utiliser ce dispositif dans  
une baignoire, une douche ou un  
réservoir rempli d'eau



P027  
Ne pas utiliser cet  
ascenseur pour des  
personnes



## Pictogrammes - Etiquettes - Panneaux Interdiction



La nouvelle norme ISO 7010 a été mise à jour en avril 2013.  
Certains panneaux sont remplacés par une version plus universelle.  
Preventimark vous garanti des panneaux conformes à la nouvelle  
législation en vigueur.

Matières	Adh	PVC	Alu	
Formats en mm	Vinyle adhésif	1,5 mm tranche blanche	2 mm tranche noire	
F1	Ø 50	1.25 € HT	2.50 € HT	3.75 € HT
F2	Ø 100	2.50 € HT	5.00 € HT	7.50 € HT
F3	Ø 200	7.00 € HT	10.50 € HT	15.75 € HT
F4	Ø 300	12.00 € HT	18.00 € HT	23.40 € HT

Les caractères de couleur ROUGE du tableau vous permettent  
de composer votre référence produit. Exemple : P028-F1-PVC

Franco de port à partir de 300 € HT



P028  
Port de gants interdit



P029  
Interdiction de photographier



P030  
Ne pas faire des noeuds sur  
la corde



P031  
Ne pas modifier la position de  
l'interrupteur



P032  
Ne pas utiliser pour la  
rectification plane



P033  
Ne pas utiliser pour la  
rectification humide



P034  
Ne pas utiliser avec une  
meuleuse portable



P150  
Défense d'entrer



P151  
Feu interdit



P152  
Sous tension ne  
pas toucher



P153  
Interdiction de tirer  
sur le câble



P154  
Interdit de souder



P155  
Interdiction de monter  
sur les chariots



P156  
Interdiction de stationner



P157  
Interdiction formelle  
de fumer



P158  
Défense de  
toucher, Haute tension



P159  
Port de la cravate interdit



P160  
Interdit de monter  
à l'échelle



P161  
Interdit aux bicyclettes



P162  
Rollers interdits



P163  
Interdit d'arroser



P164  
Interdit de huiler

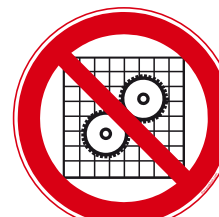

P165  
Interdit aux grilles de  
protection



P166  
Interdit à tout public



P167  
Circulation interdite



## Pictogrammes - Etiquettes - Panneaux Interdiction

### Panneaux d'interdiction

Conformes aux normes européennes pour la signalisation de sécurité et la santé sur les lieux de travail (Directive 92/58 du 24 juin 1992)

Formats en mm	Matières	Adh Vinyle adhésif	PVC 1,5 mm tranche blanche	Alu 2 mm tranche noire
F1	Ø 50	1.25 € HT	2.50 € HT	3.75 € HT
F2	Ø 100	2.50 € HT	5.00 € HT	7.50 € HT
F3	Ø 200	7.00 € HT	10.50 € HT	15.75 € HT
F4	Ø 300	12.00 € HT	18.00 € HT	23.40 € HT

Les caractères de couleur **ROUGE** du tableau vous permettent de composer votre référence produit. Exemple : P168-F1-PVC

Franco de port à partir de 300 € HT



P168  
Ne pas travailler à plusieurs sur la machine



P169  
Passagers interdits sur les chariots élévateurs



P170  
Ne pas passer sous la charge

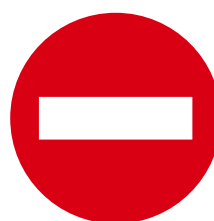

P171  
Sens interdit



P172



P173  
Ne pas courir en entrant



P174  
Accès interdit aux personnes non autorisées



P175  
Accès interdit aux personnes non autorisées



P176  
Défense d'entrer



P177  
Défense d'entrer



P178  
Interdiction de fumer



P179  
Interdiction de faire du feu



P180  
Feu de métaux interdit



P181  
Feu de liquides inflammables interdit



P182  
Port des gants interdit



P183  
Interdiction de toucher



P184  
Interdiction de toucher



P185  
Ne pas mettre les mains



P186  
Ne pas mettre sous tension



P187  
Ne pas sonner



P188  
Ne pas couper l'alimentation



P189  
Ne pas mettre la main



P190



P191  
Ascenseur interdit aux personnes



P192  
Ascenseur interdit aux personnes



## Pictogrammes - Etiquettes - Panneaux Interdiction

### Panneaux d'interdiction

Conformes aux normes européennes pour la signalisation de sécurité et la santé sur les lieux de travail (Directive 92/58 du 24 juin 1992)

Formats en mm	Matières	Adh Vinyle adhésif	PVC 1,5 mm tranche blanche	Alu 2 mm tranche noire
F1	Ø 50	1.25 € HT	2.50 € HT	3.75 € HT
F2	Ø 100	2.50 € HT	5.00 € HT	7.50 € HT
F3	Ø 200	7.00 € HT	10.50 € HT	15.75 € HT
F4	Ø 300	12.00 € HT	18.00 € HT	23.40 € HT

Les caractères de couleur **ROUGE** du tableau vous permettent de composer votre référence produit. Exemple : P193-F1-PVC

Franco de port à partir de 300 € HT



P193  
Interdiction d'arroser



P194  
Interdiction de cadenasser



P195  
Interdit aux voitures



P196  
Interdit aux poids lourds



P197  
Interdiction de monter sur les chariots



P198  
Interdit aux chariots élévateurs



P199  
Passagers interdits sur les chariots élévateurs



P200  
Interdit de stationner sous la charge



P201  
Déjections canines interdites



P202  
Déjections canines interdites



P203  
Interdiction de courir



P204  
Téléphone interdit



P205  
Téléphone interdit



P206  
Interdiction de photographier



P207  
Interdiction de boire Eau non potable



P208  
Interdiction de manger



P209  
Interdiction de boire



P210  
Interdiction de boire



P211  
Interdiction de boire



P212  
Interdiction de manger



P213  
Ne pas mettre sous tension



P214  
Feu interdit



P215  
Feu de liquides inflammables interdit



P216  
Feu de gaz interdit



P217  
Feu de métaux interdit



## Pictogrammes - Etiquettes - Panneaux Interdiction

### Panneaux d'interdiction

Conformes aux normes européennes pour la signalisation de sécurité et la santé sur les lieux de travail (Directive 92/58 du 24 juin 1992)

Formats en mm	Matières	Adh Vinyle adhésif	PVC 1,5 mm tranche blanche	Alu 2 mm tranche noire
F1	Ø 50	1.25 € HT	2.50 € HT	3.75 € HT
F2	Ø 100	2.50 € HT	5.00 € HT	7.50 € HT
F3	Ø 200	7.00 € HT	10.50 € HT	15.75 € HT
F4	Ø 300	12.00 € HT	18.00 € HT	23.40 € HT

Les caractères de couleur **ROUGE** du tableau vous permettent de composer votre référence produit. Exemple : P218-F1-PVC

Franco de port à partir de 300 € HT



P218  
Feu d'huiles interdit



P219  
Interdiction d'utiliser l'extincteur



P220  
Ne pas toucher l'engrenage



P221  
Ne pas toucher les rouleaux



P222  
Ne pas mettre ma main  
Risque d'écrasement



P223  
Interdiction de souder



P224  
Interdit aux poids lourds



P225  
Interdit de stationner sur les  
passages piétons



P226  
Interdit de transvaser



P227  
Interdit aux avions



P228  
Interdit aux cycles



P229  
Echelle interdite



P230  
Ne pas monter sur l'appareil



P231  
Ne pas se tenir sous l'appareil



P232  
Ne pas monter sur l'appareil



P233  
Interdiction d'escalader



P234  
Interdiction d'escalader



P235  
Aérosols interdits



P236  
Défense d'entreposer des bidons



P237  
Défense d'entreposer des objets



P238  
Interdit aux enfants



P239  
Interdit aux enfants



P240  
Interdit aux poussettes



P241  
Ascenseur interdit aux enfants



P242  
Interdiction de jeter dans la  
poubelle





## Pictogrammes - Etiquettes - Panneaux Interdiction

### Panneaux d'interdiction

Conformes aux normes européennes pour la signalisation de sécurité et la santé sur les lieux de travail (Directive 92/58 du 24 juin 1992)

Formats en mm	Matières	Adh Vinyle adhésif	PVC 1,5 mm tranche blanche	Alu 2 mm tranche noire
F1	Ø 50	1.25 €HT	2.50 €HT	3.75 €HT
F2	Ø 100	2.50 €HT	5.00 €HT	7.50 €HT
F3	Ø 200	7.00 €HT	10.50 €HT	15.75 €HT
F4	Ø 300	12.00 €HT	18.00 €HT	23.40 €HT

Les caractères de couleur **ROUGE** du tableau vous permettent de composer votre référence produit. Exemple : P243-F1-PVC

Franco de port à partir de 300 € HT



P243  
Interdiction de jeter les déchets



P244  
Interdiction de klaxonner



P245  
Ne pas toucher



P246  
Interdit aux chiens



P247  
Port de blouse interdit



P248  
Casque de moto interdit



P249  
Défense d'utiliser des cartes magnétiques



P250  
Armes interdites



P251  
Armes à feu interdites



P252  
Lecteurs audio interdits



P253  
Radios interdites



P254  
Trotinettes interdites



P255  
Rollers interdits



P256  
Skateboards interdits



P257  
Baignade interdite



P258  
Interdiction de plonger



P259  
Ba teaux à moteur interdits



P260  
Pêche interdite



P261  
Plomb interdit



P262  
Port des gants interdit



P263  
Port des chaussures interdit



P264  
Interdit de monter sur la marche



P265  
Ballons interdits



P266  
Ne pas mouiller



P267  
Ne pas verser à l'égout



## Pictogrammes - Etiquettes - Panneaux Interdiction

### Panneaux d'interdiction

Conformes aux normes européennes pour la signalisation de sécurité et la santé sur les lieux de travail (Directive 92/58 du 24 juin 1992)

Matières	Adh Vinyle adhésif	PVC 1,5 mm tranche blanche	Alu 2 mm tranche noire
<b>F1</b> Ø 50	1.25 € HT	2.50 € HT	3.75 € HT
<b>F2</b> Ø 100	2.50 € HT	5.00 € HT	7.50 € HT
<b>F3</b> Ø 200	7.00 € HT	10.50 € HT	15.75 € HT
<b>F4</b> Ø 300	12.00 € HT	18.00 € HT	23.40 € HT

Les caractères de couleur **ROUGE** du tableau vous permettent de composer votre référence produit. Exemple : P268-F1-PVC

Franco de port à partir de 300 € HT



P268  
Défense de toucher



P269  
Interdiction aux enfant de moins de 3 ans



P270  
Emetteur/récepteur interdit



P271  
Nourriture interdite



P272  
Défense d'entrer



P273  
Défense d'entrer



P274  
Défense de faire demi-tour à gauche



P275  
Défense de faire demi-tour à droite



P276  
Défense de tourner à gauche



P277  
Défense de tourner à droite



P278  
Arrêt et stationnement interdit



P279  
Stationnement interdit



## Pictogrammes - Etiquettes - Panneaux Interdiction

### Panneaux d'interdiction

Conformes aux normes européennes pour la signalisation de sécurité et la santé sur les lieux de travail (Directive 92/58 du 24 juin 1992)

Formats en mm	Matières	Adh Vinyle adhésif	PVC 1,5 mm tranche blanche	Alu 2 mm tranche noire
F1	50 x 150	3.00 € HT	6.00 € HT	9.00 € HT
F2	100 x 300	5.50 € HT	10.00 € HT	15.00 € HT
F3	150 x 450	12.00 € HT	18.00 € HT	25.20 € HT
F4	200 x 600	19.00 € HT	24.70 € HT	32.11 € HT

Les caractères de couleur **ROUGE** du tableau vous permettent de composer votre référence produit. Exemple : P300-F1-PVC

Franco de port à partir de 300 € HT



P300



P301



P302



P303



P304



P305



P306



P307



P308



P309



**LE + PREVENTI !**

*Personnalisez votre panneau : vous choisissez votre texte, nous le réalisons au même prix.*



P310



## Pictogrammes - Etiquettes - Panneaux Interdiction

### Panneaux d'interdiction

Conformes aux normes européennes pour la signalisation de sécurité et la santé sur les lieux de travail (Directive 92/58 du 24 juin 1992)

Matières	Adh Vinyle adhésif	PVC 1,5 mm tranche blanche	Alu 2 mm tranche noire
<b>F1</b> 50 x 150	3.00 € HT	6.00 € HT	9.00 € HT
<b>F2</b> 100 x 300	5.50 € HT	10.00 € HT	15.00 € HT
<b>F3</b> 150 x 450	12.00 € HT	18.00 € HT	25.20 € HT
<b>F4</b> 200 x 600	19.00 € HT	24.70 € HT	32.11 € HT

Les caractères de couleur **ROUGE** du tableau vous permettent de composer votre référence produit. Exemple : P500-F3-PVC

Franco de port à partir de 300 € HT



P500



P501



P502



P503



P504



P505



P506



P507



P508



P509



P510



P511



P512



P513



P514



P515



P516



P517



## Pictogrammes - Etiquettes - Panneaux Interdiction

### Panneaux d'interdiction

Conformes aux normes européennes pour la signalisation de sécurité et la santé sur les lieux de travail (Directive 92/58 du 24 juin 1992)

Matières	Adh Vinyle adhésif	PVC 1,5 mm tranche blanche	Alu 2 mm tranche noire
<b>F1</b> 50 x 150	3.00 € HT	6.00 € HT	9.00 € HT
<b>F2</b> 100 x 300	5.50 € HT	10.00 € HT	15.00 € HT
<b>F3</b> 150 x 450	12.00 € HT	18.00 € HT	25.20 € HT
<b>F4</b> 200 x 600	19.00 € HT	24.70 € HT	32.11 € HT

Les caractères de couleur **ROUGE** du tableau vous permettent de composer votre référence produit. Exemple : P518-F3-Alu

Franco de port à partir de 300 € HT



P518



P519



P520



P521



P522



P523



P524



P525



P526



P527



P528



P529



P530



P531



P532



P533



P534



P535



## Pictogrammes - Etiquettes - Panneaux Interdiction

### Panneaux d'interdiction

Conformes aux normes européennes pour la signalisation de sécurité et la santé sur les lieux de travail (Directive 92/58 du 24 juin 1992)

Matières	Adh Vinyle adhésif	PVC 1,5 mm tranche blanche	Alu 2 mm tranche noire
<b>F1</b> 50 x 150	3.00 € HT	6.00 € HT	9.00 € HT
<b>F2</b> 100 x 300	5.50 € HT	10.00 € HT	15.00 € HT
<b>F3</b> 150 x 450	12.00 € HT	18.00 € HT	25.20 € HT
<b>F4</b> 200 x 600	19.00 € HT	24.70 € HT	32.11 € HT

Les caractères de couleur **ROUGE** du tableau vous permettent de composer votre référence produit. Exemple : P536-F2-Adh

Franco de port à partir de 300 € HT



P536



P537



P538



P539



P540



P541



P542



P543



P544



P545



P546



P547



P548



P549



P550



P551



P552



P553





## Pictogrammes - Etiquettes - Panneaux Interdiction

### Panneaux d'interdiction

Conformes aux normes européennes pour la signalisation de sécurité et la santé sur les lieux de travail (Directive 92/58 du 24 juin 1992)

Matières	Adh Vinyle adhésif	PVC 1,5 mm tranche blanche	Alu 2 mm tranche noire
<b>F1</b> 50 x 150	3.00 € HT	6.00 € HT	9.00 € HT
<b>F2</b> 100 x 300	5.50 € HT	10.00 € HT	15.00 € HT
<b>F3</b> 150 x 450	12.00 € HT	18.00 € HT	25.20 € HT
<b>F4</b> 200 x 600	19.00 € HT	24.70 € HT	32.11 € HT

Les caractères de couleur **ROUGE** du tableau vous permettent de composer votre référence produit. Exemple : P554-F2-Alu

Franco de port à partir de 300 € HT



P554



P555



P556



P557



P558



P559



P560



P561



**LE + PREVENTI !**

*Personnalisez votre panneau : vous choisissez votre pictogramme et votre texte, nous le réalisons au même prix.*



P562



## Pictogrammes - Etiquettes - Panneaux Interdiction

### Panneaux d'interdiction

Conformes aux normes européennes pour la signalisation de sécurité et la santé sur les lieux de travail (Directive 92/58 du 24 juin 1992)

Matières	Adh Vinyle adhésif	PVC 1,5 mm tranche blanche	Alu 2 mm tranche noire
<b>F1</b> 50 x 75	2.50 € HT	5.00 € HT	7.50 € HT
<b>F2</b> 100 x 150	4.00 € HT	8.00 € HT	12.00 € HT
<b>F3</b> 150 x 225	10.00 € HT	15.00 € HT	21.00 € HT
<b>F4</b> 200 x 300	15.00 € HT	21.00 € HT	27.30 € HT

Les caractères de couleur **ROUGE** du tableau vous permettent de composer votre référence produit. Exemple : P700-F4-Alu

Franco de port à partir de 300 € HT



P700



P701



P702



P703



P704



P705



P706



P707



P708



P709



P710



P711

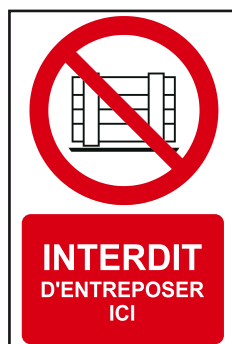

P712



P713



P714



P715



## Pictogrammes - Etiquettes - Panneaux Interdiction

### Panneaux d'interdiction

Conformes aux normes européennes pour la signalisation de sécurité et la santé sur les lieux de travail (Directive 92/58 du 24 juin 1992)

Matières	Adh Vinyle adhésif	PVC 1,5 mm tranche blanche	Alu 2 mm tranche noire
<b>F1</b> 50 x 75	2.50 € HT	5.00 € HT	7.50 € HT
<b>F2</b> 100 x 150	4.00 € HT	8.00 € HT	12.00 € HT
<b>F3</b> 150 x 225	10.00 € HT	15.00 € HT	21.00 € HT
<b>F4</b> 200 x 300	15.00 € HT	21.00 € HT	27.30 € HT

Les caractères de couleur **ROUGE** du tableau vous permettent de composer votre référence produit. Exemple : P715-F2-PVC

Franco de port à partir de 300 € HT



P716



P717



P718



**LE + PREVENTI !**

*Personnalisez votre panneau : vous choisissez votre pictogramme et votre texte, nous le réalisons au même prix.*



P719



## Pictogrammes - Etiquettes - Panneaux Interdiction

### Panneaux d'interdiction

Conformes aux normes européennes pour la signalisation de sécurité et la santé sur les lieux de travail (Directive 92/58 du 24 juin 1992)

Formats en mm	Matières	Adh Vinyle adhésif	PVC 1,5 mm tranche blanche	Alu 2 mm tranche noire
<b>F1</b> 50 x 100		2.50 €HT	5.00 €HT	7.50 €HT
<b>F2</b> 75 x 150		4.00 €HT	8.00 €HT	12.00 €HT
<b>F3</b> 125 x 250		10.00 €HT	15.00 €HT	21.00 €HT
<b>F4</b> 250 x 500		15.00 €HT	21.00 €HT	27.30 €HT

Les caractères de couleur **ROUGE** du tableau vous permettent de composer votre référence produit. Exemple : P900-F4-Adh

Franco de port à partir de 300 € HT

**DEFENSE DE  
PASSER SOUS  
LA CHARGE**

P900

**DEFENSE DE  
PASSER DANS LA  
ZONE DE  
MANOEUVRE**

P901

**ISSUE DE SECOURS  
DEFENSE  
DE STATIONNER**

P902

**DEFENSE  
D'ENTRER**

P903

**ACCES INTERDIT A  
TOUTE PERSONNE  
ETRANGERE A LA  
SOCIETE**

P904

**DEFENSE  
D'ENTRER  
SANS AUTORISATION  
SPECIALE**

P905

**PROPRIETE  
PRIVEE  
DEFENSE  
D'ENTRER**

P906

**ACCES  
FORMELLEMENT  
INTERDIT**

P907

**ACCES  
REGLEMENTE  
ADRESSEZ-VOUS AU  
POSTE DE GARDE**

P908

**CIRCULATION  
INTERDITE A TOUTE  
PERSONNE  
ETRANGERE  
A LA SOCIETE**

P909

**ENTREE INTERDITE  
ADRESSEZ-VOUS  
AU GARDIEN**

P910

**ACCES INTERDIT A  
TOUTE PERSONNE  
NON AUTORISEE**

P911

**ACCES INTERDIT A  
TOUTE PERSONNE  
NON HABILITEE**

P912

**ENTREE  
INTERDITE**

P913

**ENTREE SANS  
BADGE  
INTERDITE**

P914

**DEFENSE  
D'ENTRER  
AVEC UNE  
FLAMME NUE**

P915

**L'UTILISATION DU  
MONTE-CHARGE  
EST INTERDITE  
AUX PERSONNES**

P916

**LAISSEZ  
LE PASSAGE  
DEGAGE**

P917



## Pictogrammes - Etiquettes - Panneaux Interdiction

### Panneaux d'interdiction

Conformes aux normes européennes pour la signalisation de sécurité et la santé sur les lieux de travail (Directive 92/58 du 24 juin 1992)

Formats en mm	Matières	Adh Vinyle adhésif	PVC 1,5 mm tranche blanche	Alu 2 mm tranche noire
<b>F1</b> 50 x 100		2.50 €HT	5.00 €HT	7.50 €HT
<b>F2</b> 75 x 150		4.00 €HT	8.00 €HT	12.00 €HT
<b>F3</b> 125 x 250		10.00 €HT	15.00 €HT	21.00 €HT
<b>F4</b> 250 x 500		15.00 €HT	21.00 €HT	27.30 €HT

Les caractères de couleur **ROUGE** du tableau vous permettent de composer votre référence produit. Exemple : P918-F4-Alu

Franco de port à partir de 300 € HT

**NE PAS  
ENCOMBRER  
L'AIRE  
DE STOCKAGE**

P918

**IL EST INTERDIT DE  
CIRCULER OU DE  
STATIONNER DANS  
L'AIRE DE MANOEUVRE  
DE L'ENGIN**

P919

**CETTE PORTE  
DOIT RESTER  
FERMEE**

P920

**IL EST INTERDIT  
D'UTILISER CET  
APPAREIL POUR LEVER  
OU TRANSPORTER DES  
PERSONNES**

P921

**N'UTILISER QUE  
LES CHEMINS  
D'ACCES  
AUTORISES**

P922

**PASSAGE  
TRES BAS**

P923

**MONTE-CHARGE  
INTERDIT AU  
PERSONNEL**

P924

**CLOTURE  
ELECTRIQUE**

P925

**CHANTIER  
INTERDIT  
AU PUBLIC**

P926

**DEFENSE  
DE  
FUMER**

P927

**DEFENSE DE  
FUMER DANS  
L'ATELIER**

P928

**DEFENSE DE  
FUMER SOUS PEINE  
DE LICENCIEMENT**

P929

**DEFENSE DE  
FUMER AU DELA  
DE CETTE LIMITE**

P930

**DEFENSE DE FUMER  
DANS L'ENCEINTE  
DE L'USINE**

P931

**DEFENSE DE FUMER  
A CE POSTE  
DE TRAVAIL**

P932

**RANGEZ  
VOS POSTES  
DE TRAVAIL**

P933

**LOCAL CLIMATISE  
FERMEZ LES  
PORTES**

P934

**FERMEZ LES  
PORTES  
ECONOMISEZ  
L'ENERGIE**

P935





## Pictogrammes - Etiquettes - Panneaux Interdiction

### Panneaux d'interdiction

Conformes aux normes européennes pour la signalisation de sécurité et la santé sur les lieux de travail (Directive 92/58 du 24 juin 1992)

Matières	Adh Vinyle adhésif	PVC 1,5 mm tranche blanche	Alu 2 mm tranche noire
<b>F1</b> 50 x 100	2.50 €HT	5.00 €HT	7.50 €HT
<b>F2</b> 75 x 150	4.00 €HT	8.00 €HT	12.00 €HT
<b>F3</b> 125 x 250	10.00 €HT	15.00 €HT	21.00 €HT
<b>F4</b> 250 x 500	15.00 €HT	21.00 €HT	27.30 €HT

Les caractères de couleur **ROUGE** du tableau vous permettent de composer votre référence produit. Exemple : P936-F2-Adh

Franco de port à partir de 300 € HT



P936



P937



P938



P939



**LE + PREVENTI !**

Personnalisez votre panneau : vous choisissez votre texte, nous le réalisons au même prix



P940





## Panneaux de sauvetage et de secours

### Caractéristiques :

- Forme rectangulaire ou carrée ;
- Pictogramme blanc sur fond vert (le vert doit recouvrir au moins 50 % de la surface du panneau).

### Exemple de panneaux à utiliser :



E001  
Sortie de secours (à gauche)



E002  
Sortie de secours (à droite)



E003  
Premiers secours



E100



### CONSEIL

### Comment choisir son format de panneau ?

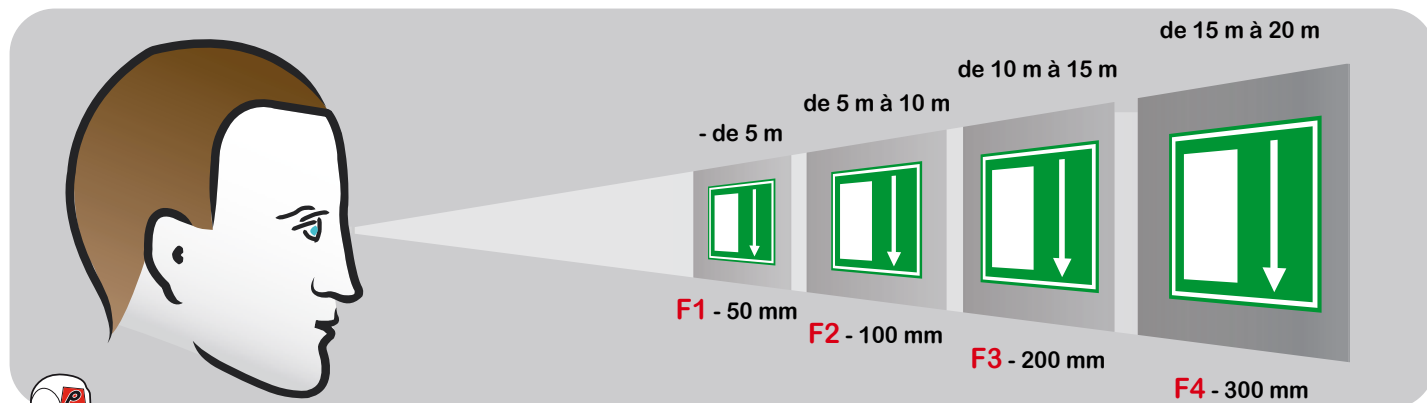

### CONSEIL

### Comment choisir sa matière ?

#### Adh

#### Adhésif

Sur surface lisse. Intérieur ou extérieur.  
Très bonne résistance aux UV, graisses et solvants  
Très bonne adhérence finale offrant une excellente tenue sur une grande variété de supports.

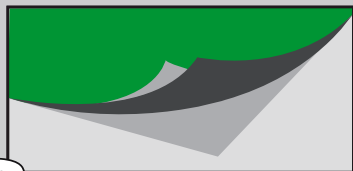

#### PVC Plaques PVC 1.5 mm

Sur surface lisse. Intérieur.  
Plaque rigide à structure allégée.  
Classée au feu M1  
Stabilité au vieillissement.

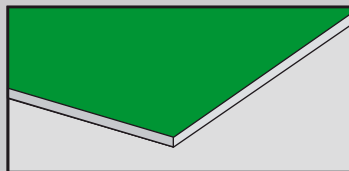

#### Alu Plaques ALU 2 mm

Sur toutes surfaces. Extérieur.  
Rigidité équivalente à celle d'une plaque d'aluminium pleine de 2,7 mm  
Très résistante aux chocs et aux intempéries.  
Résistance de - 50°C à + 90°C  
Classée au feu M1

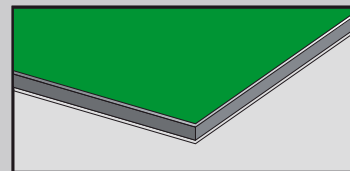

### CONSEIL

### Comment composer sa référence pour commander ?

La référence complète se compose d'une lettre et 3 chiffres pour la référence définissant le motif du panneau suivis de son format (F1, F2, F3 ou F4) et enfin de sa matière (Adh, PVC ou Alu).

Exemple : **E003-F3-PVC** pour un panneau **Premiers secours** au **Format 3** (200 mm de largeur) en **PVC**.



## Pictogrammes - Etiquettes - Panneaux Evacuation - Sauvetage



La nouvelle norme ISO 7010 a été mise à jour en avril 2013.  
Certains panneaux sont remplacés par une version plus universelle.  
Preventimark vous garanti des panneaux conformes à la nouvelle législation en vigueur.

Matières	Adh Vinyle adhésif	PVC 1,5 mm tranche blanche	Alu 2 mm tranche noire
F1 50 x 50	1.25 € HT	2.50 € HT	3.75 € HT
F2 100 x 100	2.50 € HT	5.00 € HT	7.50 € HT
F3 200 x 200	7.00 € HT	10.50 € HT	15.75 € HT
F4 300 x 300	12.00 € HT	18.00 € HT	23.40 € HT

Les caractères de couleur **ROUGE** du tableau vous permettent de composer votre référence produit.  
Exemple : E001-F3-Alu

Franco de port à partir de 300 € HT



E001  
Sortie de secours (à gauche)



E002  
Sortie de secours (à droite)

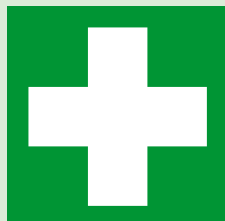

E003  
Premiers secours



E004  
Téléphone d'urgence

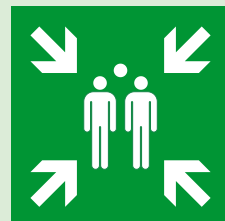

E007  
Point de rassemblement  
après évacuation



E008  
Casser pour obtenir l'accès



E009  
Médecin

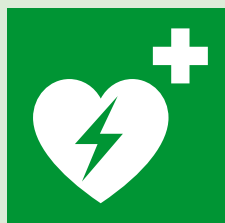

E010  
Défibrillateur automatique  
externe pour le coeur



E011  
Équipement de rinçage  
des yeux

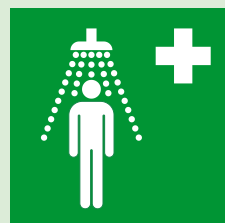

E012  
Douche de sécurité

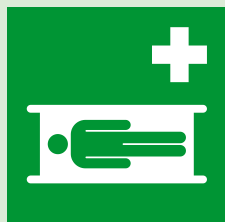

E013  
Civière



E016  
Fenêtre de secours avec  
échelle de secours



E017  
Fenêtre de secours

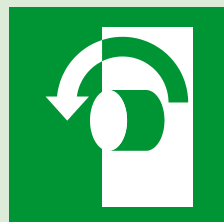

E018  
Tourner dans le sens contraire  
des aiguilles d'une montre  
pour ouvrir



E019  
Tourner dans le sens  
des aiguilles d'une montre  
pour ouvrir

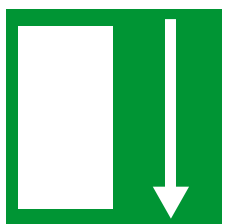

E050  
Issue de secours en bas

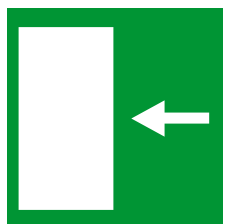

E051  
Issue de secours à gauche

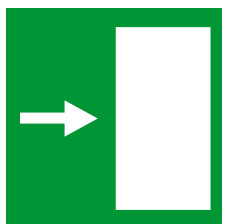

E052  
Issue de secours à droite

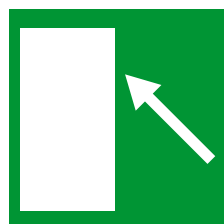

E053  
Issue de secours en haut  
à gauche

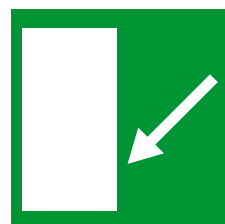

E054  
Issue de secours en haut  
à droite

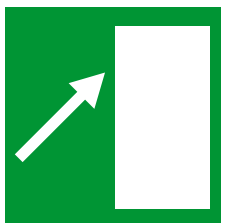

E055  
Issue de secours en haut  
à droite

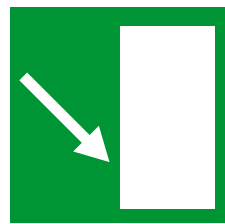

E056  
Issue de secours en bas  
à droite

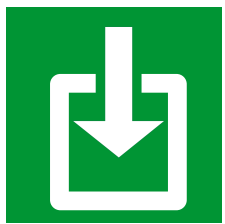

E057  
Issue de secours



E058  
Issue de secours

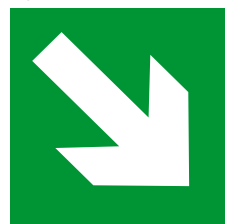

E059  
Flèche 45° bas droite



## Pictogrammes - Etiquettes - Panneaux Evacuation - Sauvetage

Panneaux de sauvetage et de secours  
Conformes aux normes européennes pour la signalisation de sécurité  
et la santé sur les lieux de travail (Directive 92/58 du 24 juin 1992)

Formats en mm	Matières	Adh Vinyle adhésif	PVC 1,5 mm tranche blanche	Alu 2 mm tranche noire
F1	50 x 50	1.25 € HT	2.50 € HT	3.75 € HT
F2	100 x 100	2.50 € HT	5.00 € HT	7.50 € HT
F3	200 x 200	7.00 € HT	10.50 € HT	15.75 € HT
F4	300 x 300	12.00 € HT	18.00 € HT	23.40 € HT

Les caractères de couleur **ROUGE** du tableau vous permettent  
de composer votre référence produit. Exemple : E050-F4-Adh

Franco de port à partir de 300 € HT

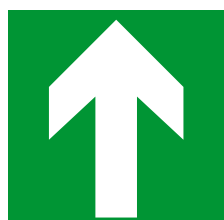

E060  
Flèche haut

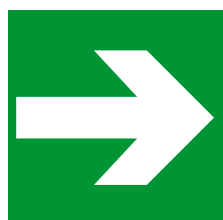

E061  
Flèche droite

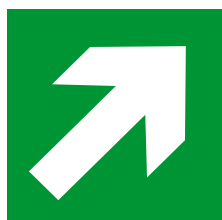

E062  
Flèche 45° haut droite

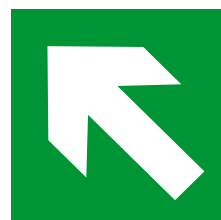

E063  
Flèche 45° haut gauche

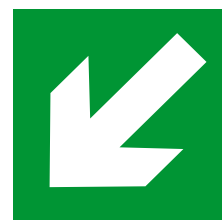

E064  
Flèche 45° bas gauche

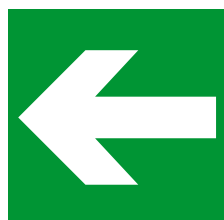

E065  
Flèche gauche

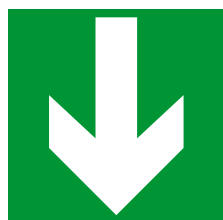

E066  
Flèche bas



E067  
Issue handicapés



E068  
Cadenas de sécurité

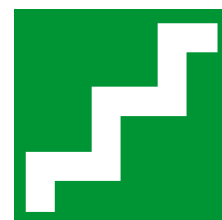

E069  
Escalier

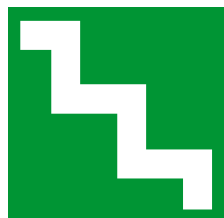

E070  
Escalier

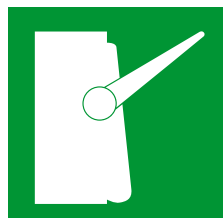

E071  
Disjoncteur



E072  
Issue de secours à gauche

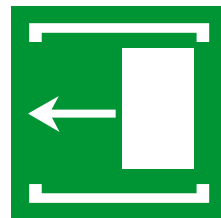

E073  
Coulisser à gauche

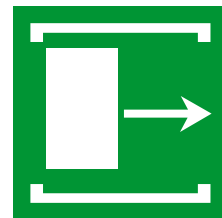

E074  
Coulisser à droite

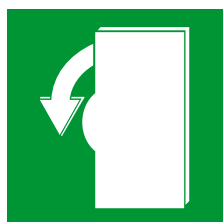

E075  
Disjoncteur

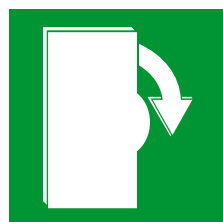

E076  
Disjoncteur



E077  
Premiers secours



E078  
Premiers secours



E079  
Premiers secours



E080  
Service médical



E081  
Secours



E082  
Secours



E083  
Premiers soins



E084  
Premiers soins



## Pictogrammes - Etiquettes - Panneaux Evacuation - Sauvetage

Panneaux de sauvetage et de secours  
Conformes aux normes européennes pour la signalisation de sécurité  
et la santé sur les lieux de travail (Directive 92/58 du 24 juin 1992)

Formats en mm	Matières	Adh Vinyle adhésif	PVC 1,5 mm tranche blanche	Alu 2 mm tranche noire
F1	50 x 50	1.25 € HT	2.50 € HT	3.75 € HT
F2	100 x 100	2.50 € HT	5.00 € HT	7.50 € HT
F3	200 x 200	7.00 € HT	10.50 € HT	15.75 € HT
F4	300 x 300	12.00 € HT	18.00 € HT	23.40 € HT

Les caractères de couleur **ROUGE** du tableau vous permettent  
de composer votre référence produit. Exemple : E050-F4-Adh

Franco de port à partir de 300 € HT

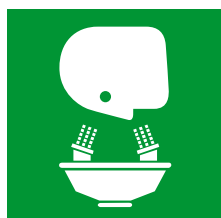

E085  
Rince-œil



E086  
Douche secours

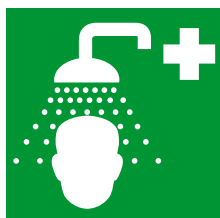

E087  
Douche secours



E088  
Téléphone secours

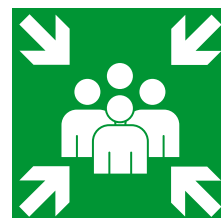

E089  
Point de rassemblement  
après évacuation



E090  
Civière

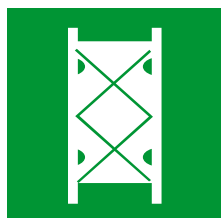

E091  
Civière



E092  
Signal d'urgence



E093  
Canot de sauvetage



E094  
Sauvetage maritime



E095  
Radeau de sauvetage



E096  
Mise à l'eau radeau de  
sauvetage



E097  
Echelle d'embarquement

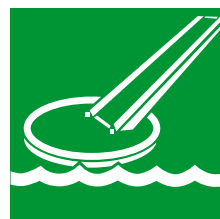

E098  
Toboggan d'évacuation

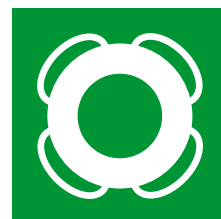

E099  
Bouée de sauvetage



E100  
Bouée de sauvetage avec  
corde

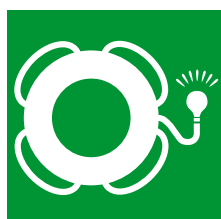

E101  
Bouée de sauvetage lumineuse



E102  
Bouée de sauvetage lumineuse  
et fusée de détresse



E103  
Gilet de sauvetage enfant



E104  
Combinaison de plongée

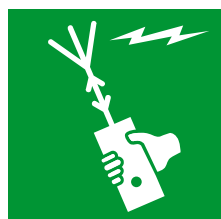

E105  
Radio portative

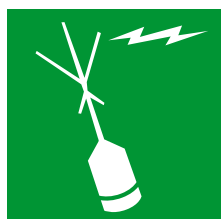

E106  
Radio guide de détresse



E107  
Radar répondeur



E108  
Poste de signal de détresse  
pyrotechnique



E109  
Lance fusée pour parachute



## Pictogrammes - Etiquettes - Panneaux Evacuation - Sauvetage

Panneaux de sauvetage et de secours

Conformes aux normes européennes pour la signalisation de sécurité et la santé sur les lieux de travail (Directive 92/58 du 24 juin 1992)

Formats en mm	Matières	Adh Vinyle adhésif	PVC 1,5 mm tranche blanche	Alu 2 mm tranche noire
F1	50 x 50	1.25 € HT	2.50 € HT	3.75 € HT
F2	100 x 100	2.50 € HT	5.00 € HT	7.50 € HT
F3	200 x 200	7.00 € HT	10.50 € HT	15.75 € HT
F4	300 x 300	12.00 € HT	18.00 € HT	23.40 € HT

Les caractères de couleur **ROUGE** du tableau vous permettent de composer votre référence produit. Exemple : E050-F4-Adh

Franco de port à partir de 300 € HT



E110  
Ligne de lancement



E111  
Chaussette télescopique d'évacuation



E112  
Rassemblement après évacuation

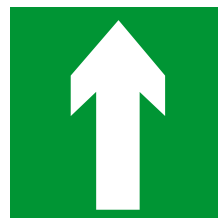

E113  
Direction

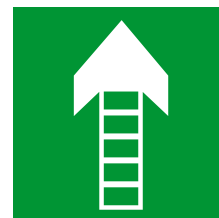

E114  
Direction évacuation



**LE + PREVENTI !**

Personnalisez votre panneau :  
vous choisissez votre pictogramme  
nous le réalisons au même prix



E115



## Pictogrammes - Etiquettes - Panneaux Evacuation - Sauvetage

Panneaux de sauvetage et de secours  
Conformes aux normes européennes pour la signalisation de sécurité  
et la santé sur les lieux de travail (Directive 92/58 du 24 juin 1992)

Formats en mm	Matières	Adh	PVC	Alu
		Vinyle adhésif	1,5 mm tranche blanche	2 mm tranche noire
F1	50 x 150	3.00 € HT	6.00 € HT	9.00 € HT
F2	100 x 300	5.50 € HT	10.00 € HT	15.00 € HT
F3	150 x 450	12.00 € HT	18.00 € HT	25.20 € HT
F4	200 x 600	19.00 € HT	24.70 € HT	32.11 € HT

Les caractères de couleur **ROUGE** du tableau vous permettent  
de composer votre référence produit. Exemple : E200 - F2-PVC

Francis de port à partir de 300 € HT

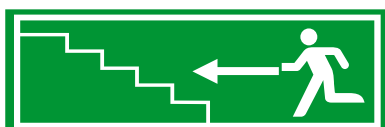

E200

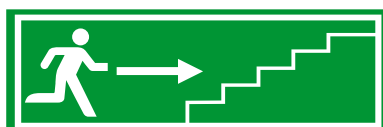

E201



E202

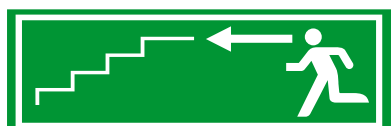

E203



E204



E205



E206



E207



E208



E209



E210



E211



E212



E213



E214



E215



E216



E217





## Pictogrammes - Etiquettes - Panneaux Evacuation - Sauvetage

Panneaux de sauvetage et de secours  
Conformes aux normes européennes pour la signalisation de sécurité  
et la santé sur les lieux de travail (Directive 92/58 du 24 juin 1992)

	Matières	Adh Vinyle adhésif	PVC 1,5 mm tranche blanche	Alu 2 mm tranche noire
<b>F1</b>	50 x 150	3.00 € HT	6.00 € HT	9.00 € HT
<b>F2</b>	100 x 300	5.50 € HT	10.00 € HT	15.00 € HT
<b>F3</b>	150 x 450	12.00 € HT	18.00 € HT	25.20 € HT
<b>F4</b>	200 x 600	19.00 € HT	24.70 € HT	32.11 € HT

Les caractères de couleur **ROUGE** du tableau vous permettent  
de composer votre référence produit. Exemple : E218-F2PVC

Franco de port à partir de 300 € HT



E218



E219



**LE + PREVENTI !**

*Personnalisez votre panneau :  
vous choisissez votre pictogramme  
et votre texte,  
nous le réalisons au même prix*



E220



## Pictogrammes - Etiquettes - Panneaux Evacuation - Sauvetage

Panneaux de sauvetage et de secours

Conformes aux normes européennes pour la signalisation de sécurité et la santé sur les lieux de travail (Directive 92/58 du 24 juin 1992)

Formats en mm	Matières	Adh Vinyle adhésif	PVC 1,5 mm tranche blanche	Alu 2 mm tranche noire
F1	50 x 75	2,50 € HT	5,00 € HT	7,50 € HT
F2	100 x 150	4,00 € HT	8,00 € HT	12,00 € HT
F3	150 x 225	10,00 € HT	15,00 € HT	21,00 € HT
F4	200 x 300	15,00 € HT	21,00 € HT	27,30 € HT

Les caractères de couleur **ROUGE** du tableau vous permettent de composer votre référence produit. Exemple : E400-F3-Alu

Franco de port à partir de 300 € HT



E400



E401



E402

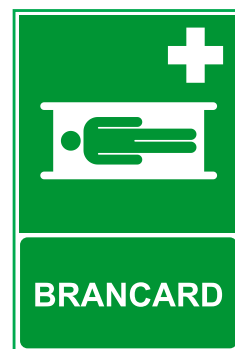

E403



E404



E405



E406



E407



E408



E409



E410



E411



E412



**LE + PREVENTI !**

*Personnalisez votre panneau :  
vous choisissez votre pictogramme  
et votre texte,  
nous le réalisons au même prix*



E413



## Pictogrammes - Etiquettes - Panneaux Evacuation - Sauvetage

Panneaux de sauvetage et de secours  
Conformes aux normes européennes pour la signalisation de sécurité  
et la santé sur les lieux de travail (Directive 92/58 du 24 juin 1992)

Formats en mm	Matières	Adh Vinyle adhésif	PVC 1,5 mm tranche blanche	Alu 2 mm tranche noire
F1	50 x 100	2.50 € HT	5.00 € HT	7.50 € HT
F2	75 x 150	4.00 € HT	8.00 € HT	12.00 € HT
F3	125 x 250	10.00 € HT	15.00 € HT	21.00 € HT
F4	250 x 500	15.00 € HT	21.00 € HT	27.30 € HT

Les caractères de couleur **ROUGE** du tableau vous permettent  
de composer votre référence produit. Exemple : E450-F2-Adh

Francis de port à partir de 300 € HT

**DOUCHE  
DE  
SECURITE**

E450

**POSTE  
DE  
PREMIERS SECOURS**

E451

**INFIRMERIE**

E452

**PHARMACIE**

E453

**LAVE OEIL**

E454

**BRULURES CHIMIQUES  
LAVAGE A L'EAU  
PENDANT  
15 MINUTES**

E455

**APPUYEZ  
SUR LA BARRE  
POUR OUVRIR**



E456



**LE + PREVENTI !**

Pers onna lisez votre pan neau :  
vous ch oisiss ez votre picto gramme  
et votre texte,  
nous le réaliso ns au même prix

**Votre  
texte**

E457



## Pictogrammes - Etiquettes - Panneaux Evacuation - Sauvetage

Panneaux de sauvetage et de secours  
Conformes aux normes européennes pour la signalisation de sécurité  
et la santé sur les lieux de travail (Directive 92/58 du 24 juin 1992)

Formats en mm	Matières	Adh Vinyle adhésif	PVC 1,5 mm tranche blanche	Alu 2 mm tranche noire
F1	50 x 200	4.00 € HT	6.50 € HT	9.00 € HT
F2	100 x 450	5.50 € HT	9.50 € HT	13.50 € HT
F3	150 x 600	11.50 € HT	16.50 € HT	22.50 € HT
F4	200 x 800	17.50 € HT	22.50 € HT	28.80 € HT

Les caractères de couleur **ROUGE** du tableau vous permettent  
de composer votre référence produit. Exemple : E500-F3-Alu

Franco de port à partir de 300 € HT



E500



E501



E502



E503



E504



E505



**LE + PREVENTI !**

Personnalisez votre panneau : vous choisissez vos pictogrammes  
et votre texte, nous le réalisons au même prix



E506



## Pictogrammes - Etiquettes - Panneaux Evacuation - Sauvetage

Panneaux de sauvetage et de secours  
Conformes aux normes européennes pour la signalisation de sécurité  
et la santé sur les lieux de travail (Directive 92/58 du 24 juin 1992)

Matières	Adh Vinyle adhésif	PVC 1,5 mm tranche blanche	Alu 2 mm tranche noire
<b>F1</b> Ø 50	1.25 € HT	2.50 € HT	3.75 € HT
<b>F2</b> Ø 100	2.50 € HT	5.00 € HT	7.50 € HT
<b>F3</b> Ø 200	7.00 € HT	10.50 € HT	15.75 € HT
<b>F4</b> Ø 300	12.00 € HT	18.00 € HT	23.40 € HT

Les caractères de couleur **ROUGE** du tableau vous permettent  
de composer votre référence produit. Exemple : E600-F1-PVC

Franco de port à partir de 300 € HT



E600



E601



E602



E603



E604



E605



E606



E607



## Panneaux concernant le matériel ou l'équipement de lutte contre l'incendie

### Caractéristiques :

- Forme rectangulaire ou carrée ;
- Pictogramme blanc sur fond rouge (la couleur rouge doit recouvrir au moins 50 % de la surface du panneau).

### Exemple de panneaux à utiliser :



F001  
Extincteur



F002  
Robinet d'incendie armé



F003  
Echelle d'incendie



F150



### CONSEIL

### Comment choisir son format de panneau ?

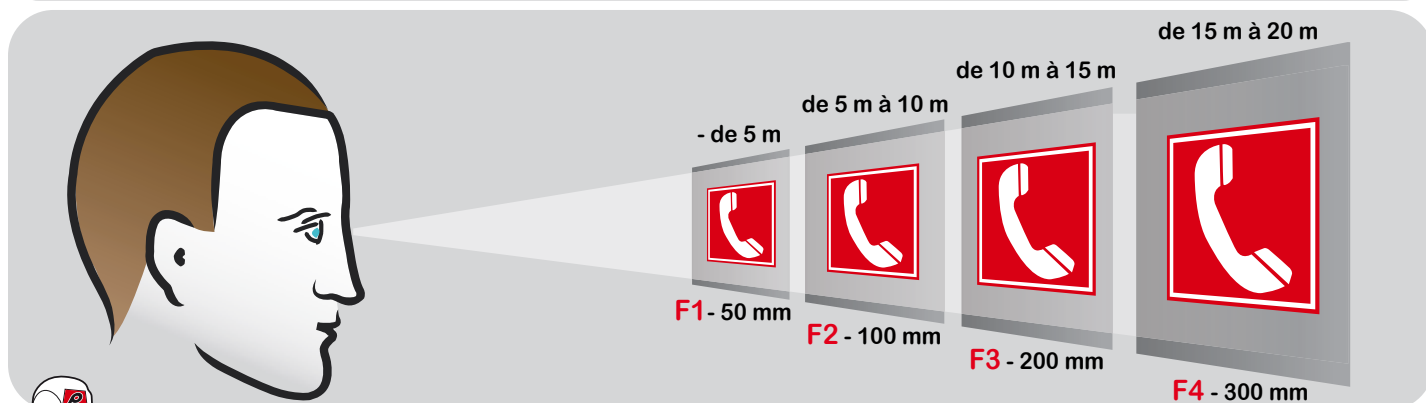

### CONSEIL

### Comment choisir sa matière ?

#### Adh

#### Adhésif

Sur surface lisse. Intérieur ou extérieur.  
Très bonne résistance aux UV, graisses et solvants  
Très bonne adhérence finale offrant une excellente tenue sur une grande variété de supports.

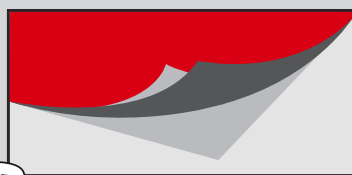

#### PVC Plaques PVC 1.5 mm

Sur surface lisse. Intérieur.  
Plaque rigide à structure allégée.  
Classée au feu M1  
Stabilité au vieillissement.

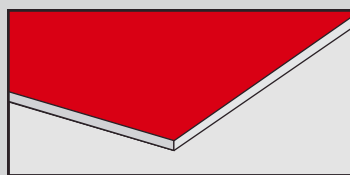

#### Alu Plaques ALU 2 mm

Sur toutes surfaces. Extérieur.  
Rigidité équivalente à celle d'une plaque d'aluminium pleine de 2,7 mm  
Très résistante aux chocs et aux intempéries.  
Résistance de - 50°C à + 90°C  
Classée au feu M1

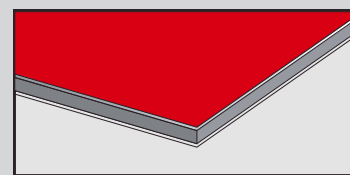

### CONSEIL

### Comment composer sa référence pour commander ?

La référence complète se compose d'une lettre et 3 chiffres pour la référence définissant le motif du panneau suivis de son format (F1, F2, F3 ou F4) et enfin de sa matière (Adh, PVC ou Alu).

Exemple : **F002-F4-Alu** pour un panneau **Robinet d'incendie armé** au **Format 4** (300 mm de largeur) en **Alu**.





## Pictogrammes - Etiquettes - Panneaux Sécurité - Incendie



La nouvelle norme ISO 7010 a été mise à jour en avril 2013.  
Certains panneaux sont remplacés par une version plus universelle.  
Preventimark vous garantit des panneaux conformes à la nouvelle législation en vigueur.

Formats en mm	Matières	Adh Vinyle adhésif	PVC 1,5 mm tranche blanche	Alu 2 mm tranche noire
F1	50 x 50	1.25 €HT	2.50 €HT	3.75 €HT
F2	100 x 100	2.50 €HT	5.00 €HT	7.50 €HT
F3	200 x 200	7.00 €HT	10.50 €HT	15.75 €HT
F4	300 x 300	12.00 €HT	18.00 €HT	23.40 €HT

Les caractères de couleur ROUGE du tableau vous permettent de composer votre référence produit. Exemple : F001-F3-Alu

Franco de port à partir de 300 € HT



F001  
Extincteur



F002  
Robinet d'incendie armé

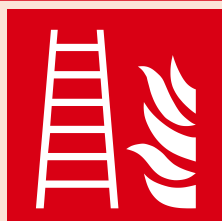

F003  
Echelle d'incendie



F004  
Ensemble d'équipements  
de lutte contre l'incendie



F005  
Point d'alarme incendie



F006  
Téléphone à utiliser  
en cas d'incendie

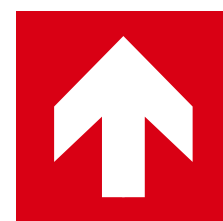

F010  
Evacuation

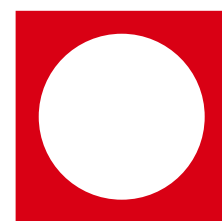

F011  
Baies d'accès pompiers

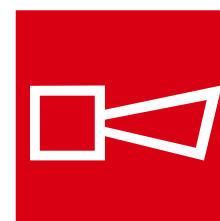

F012  
Avertisseur sonore



F013  
En cas d'incendie  
briser la glace



F014  
Sirène d'alarme



F015  
Porte coupe-feu

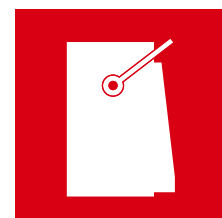

F016  
Arrêt d'urgence



F017  
Porte coupe-feu



F018  
Extincteur



F019  
Extincteur



F020  
Extincteur

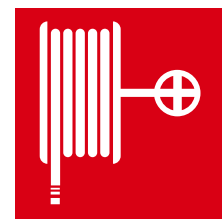

F021  
Robinet d'incendie armé

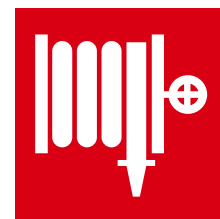

F022  
Robinet d'incendie armé



F023  
Tuyau incendie



F024  
Téléphone à utiliser en  
cas d'incendie



F025  
Téléphone à utiliser en  
cas d'incendie



F026  
Téléphone à utiliser en  
cas d'incendie



F027  
Casser pour obtenir l'accès



F028  
Couverture anti-feu



## Pictogrammes - Etiquettes - Panneaux Sécurité - Incendie

Panneaux concernant le matériel ou l'équipement de lutte contre l'incendie  
Conformes aux normes européennes pour la signalisation de sécurité  
et la santé sur les lieux de travail (Directive 92/58 du 24 juin 1992)

Matières	Adh Vinyle adhésif	PVC 1,5 mm tranche blanche	Alu 2 mm tranche noire
<b>F1</b> 50 x 50	1.25 € HT	2.50 € HT	3.75 € HT
<b>F2</b> 100 x 100	2.50 € HT	5.00 € HT	7.50 € HT
<b>F3</b> 200 x 200	7.00 € HT	10.50 € HT	15.75 € HT
<b>F4</b> 300 x 300	12.00 € HT	18.00 € HT	23.40 € HT

Les caractères de couleur **ROUGE** du tableau vous permettent  
de composer votre référence produit. Exemple : P100-F4-Adh

Franco de port à partir de 300 € HT



F029  
Echelle incendie



F030

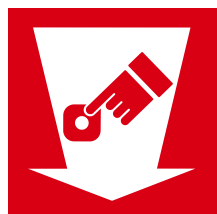

F031  
Indicateur d'incendie

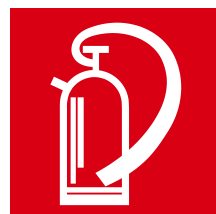

F032  
Extincteur



F033  
Signal incendie

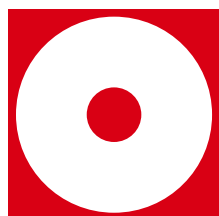

F034  
signal incendie



F035  
Evacuation incendie

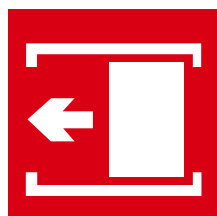

F036  
Porte coulissante à gauche

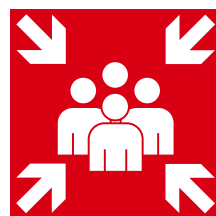

F037  
Point de rassemblement

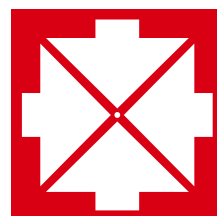

F038  
Point de rassemblement

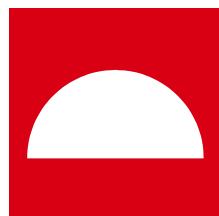

F039  
Équipement de lutte contre  
l'incendie



F040  
Porte coupe-feu

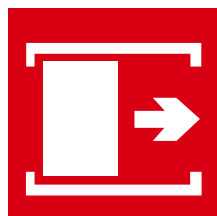

F041  
Porte coulissante à droite



## Pictogrammes - Etiquettes - Panneaux Sécurité - Incendie

Panneaux concernant le matériel ou l'équipement de lutte contre l'incendie  
Conformes aux normes européennes pour la signalisation de sécurité  
et la santé sur les lieux de travail (Directive 92/58 du 24 juin 1992)

Matières	Adh Vinyle adhésif	PVC 1,5 mm tranche blanche	Alu 2 mm tranche noire
<b>F1</b> 50 x 150	3.00 € HT	6.00 € HT	9.00 € HT
<b>F2</b> 100 x 300	5.50 € HT	10.00 € HT	15.00 € HT
<b>F3</b> 150 x 450	12.00 € HT	18.00 € HT	25.20 € HT
<b>F4</b> 200 x 600	19.00 € HT	24.70 € HT	32.11 € HT

Les caractères de couleur **ROUGE** du tableau vous permettent  
de composer votre référence produit. Exemple : P100-F4-Adh

Franco de port à partir de 300 € HT

**TELEPHONE  
D'ALARME**

F100

**EXTINCTEUR**

F101

**ROBINET  
D'INCENDIE ARME**

F102

**EHELLE**

F103

**RIA**

F104

**BOUCHE  
D'INCENDIE**

F105

**COUVERTURE  
ANTI-FEU**

F106

**VANNE D'ARRET  
D'URGENCE**

F107

**ARRET  
D'URGENCE**

F108

**LANCE  
D'INCENDIE**

F109

**POSTE  
D'INCENDIE**

F110

**AVERTISSEUR  
D'INCENDIE**

F111

**SIRENE  
D'ALARME**

F112

**INTERRUPTEUR  
D'URGENCE**

F113

**COMMANDE  
D'ARRET  
D'URGENCE**

F114

**NE PAS UTILISER  
SUR FLAMME  
GAZ**

F115

**EHELLE  
D'INTERVENTION**

F116

**PORTE COUPE-FEU  
A MAINTENIR  
FERMEE**

F117

**PORTE COUPE-FEU  
NE METTEZ PAS D'OBSTACLE  
A LA FERMETURE**

F118

**BAC  
A SABLE**

F119

**PRISE D'EAU  
INCENDIE**

F120



## Pictogrammes - Etiquettes - Panneaux Sécurité - Incendie

Panneaux concernant le matériel ou l'équipement de lutte contre l'incendie  
Conformes aux normes européennes pour la signalisation de sécurité  
et la santé sur les lieux de travail (Directive 92/58 du 24 juin 1992)

Formats en mm	Matières	Adh Vinyle adhésif	PVC 1,5 mm tranche blanche	Alu 2 mm tranche noire
F1	50 x 150	3.00 € HT	6.00 € HT	9.00 € HT
F2	100 x 300	5.50 € HT	10.00 € HT	15.00 € HT
F3	150 x 450	12.00 € HT	18.00 € HT	25.20 € HT
F4	200 x 600	19.00 € HT	24.70 € HT	32.11 € HT

Les caractères de couleur **ROUGE** du tableau vous permettent  
de composer votre référence produit. Exemple : P121-F2-Alu

Franco de port à partir de 300 € HT

**EXTINCTEUR  
SUR ROUES**

F121

**EXTINCTEUR POUR  
FEUX ELECTRIQUES**

F122

**COMMANDE OUVERTURE  
TRAPPE DESENFUMAGE**

F123

**DESENFUMAGE**

F124

**COLONNE  
SECHE**

F125

**COLONNE  
HUMIDE**

F126

**PORTE  
COUPE-FEU**

F127

**PORTE  
COUPE-FEU  
NE PAS ENCOMBRER**

F128

**VANNE  
INCENDIE**

F129

**BY-PASS  
INCENDIE**

F130

**NE PAS  
ENCOMBRER**

F131

**PRISE D'EAU  
INCENDIE  
NE PAS ENCOMBRER**

F132

**MAINTENIR OUVERT  
PENDANT LES  
HEURES DE TRAVAIL**

F133

**PORTE A MAINTENIR  
FERMEE**

F134

**ALARME  
INCENDIE**

F135

**EXTINCTION  
AUTOMATIQUE**

F136

**PORTE  
COUPE-FEU  
A MAINTENIR OUVERTE**

F137

**BASSIN D'EAU  
INCENDIE**

F138

**PORTE COUPE-FEU  
FERMETURE  
AUTOMATIQUE**

F139

**ARMOIRE  
INCENDIE**

F140

**DETECTION  
AUTOMATIQUE  
DE FUMEE**

F141



## Pictogrammes - Etiquettes - Panneaux Sécurité - Incendie

Panneaux concernant le matériel ou l'équipement de lutte contre l'incendie  
Conformes aux normes européennes pour la signalisation de sécurité  
et la santé sur les lieux de travail (Directive 92/58 du 24 juin 1992)

Formats en mm	Matières	Adh Vinyle adhésif	PVC 1,5 mm tranche blanche	Alu 2 mm tranche noire
F1	50 x 150	3.00 € HT	6.00 € HT	9.00 € HT
F2	100 x 300	5.50 € HT	10.00 € HT	15.00 € HT
F3	150 x 450	12.00 € HT	18.00 € HT	25.20 € HT
F4	200 x 600	19.00 € HT	24.70 € HT	32.11 € HT

Les caractères de couleur **ROUGE** du tableau vous permettent  
de composer votre référence produit. Exemple : P142-F3-PVC

Franco de port à partir de 300 € HT

**TRAVAUX PAR POINT  
CHAUD INTERDITS  
SANS PERMIS DE FEU**

F142

**DETECTEUR  
DE FUMEE  
AUTONOME**

F143

**A N'UTILISER  
QU'EN CAS D'INCENDIE  
OU SUR ORDRE**

F144

**TRAPPE DE  
DESENFUMAGE**

F145

**PELLE ET SEAU  
INCENDIE**

F146

**NE PAS UTILISER  
SUR FEUX  
ELECTRIQUES**

F147

**CABLE  
D'ARRET  
D'URGENCE**

F148

**MOTOPOMPE**

F149

**DEFENSE DE FUMER  
ET DE PENETRER  
AVEC UNE FLAMME**

F150

**DEFENSE DE FUMER  
MATIERES  
INFLAMMABLES**

F151

**DEFENSE DE FUMER  
GAZ  
INFLAMMABLES**

F152

**DEFENSE DE FUMER  
DEPOT DE PROPANE**

F153

**DEFENSE DE FUMER  
DEPOT DE BUTANE**

F154

**LA DISTRIBUTION D'ESSENCE NE  
DOIT ETRE EFFECTUEE  
QU' APRES L'ARRET DU MOTEUR  
DEFENSE DE FUMER**

F155

**CONDUCTEURS  
ELECTRIQUES  
DEFENSE D'OUVRIR**

F156

**DEFENSE DE  
MONTER**

F157

**DEFENSE ABSOLUE  
DE TOUCHER**

F158

**DEFENSE D'OUVRIR  
CETTE CELLULE TANT QUE LES  
CONDUCTEURS QU'ELLE CONTIENT  
SONT SOUS TENSION**

F159



## Pictogrammes - Etiquettes - Panneaux Sécurité - Incendie

Panneaux concernant le matériel ou l'équipement de lutte contre l'incendie  
Conformes aux normes européennes pour la signalisation de sécurité  
et la santé sur les lieux de travail (Directive 92/58 du 24 juin 1992)

	Matières	Adh Vinyle adhésif	PVC 1,5 mm tranche blanche	Alu 2 mm tranche noire
<b>F1</b>	<b>50 x 150</b>	3.00 € HT	6.00 € HT	9.00 € HT
<b>F2</b>	<b>100 x 300</b>	5.50 € HT	10.00 € HT	15.00 € HT
<b>F3</b>	<b>150 x 450</b>	12.00 € HT	18.00 € HT	25.20 € HT
<b>F4</b>	<b>200 x 600</b>	19.00 € HT	24.70 € HT	32.11 € HT

Les caractères de couleur **ROUGE** du tableau vous permettent  
de composer votre référence produit. Exemple : P163-F4-PVC

Franco de port à partir de 300 € HT

**EN REPARATION  
DEFENSE  
DE MANOEUVRER**

F163

**COUPURE  
GENERALE  
D'ELECTRICITE**

F164

**ACCES INTERDIT  
DANGER  
PERMANENT**

F165

**ENTREE  
INTERDITE**

F166

**PRIVE**

F167

**VEUILLEZ FERMER  
LA PORTE SVP**

F168



**LE + PREVENTI !**

*Personnalisez votre panneau : vous choisissez votre texte,  
nous le réalisons au même prix*

**Votre  
texte**

F169





## Pictogrammes - Etiquettes - Panneaux Sécurité - Incendie

Panneaux concernant le matériel ou l'équipement de lutte contre l'incendie  
Conformes aux normes européennes pour la signalisation de sécurité  
et la santé sur les lieux de travail (Directive 92/58 du 24 juin 1992)

Formats en mm	Matières	Adh Vinyle adhésif	PVC 1,5 mm tranche blanche	Alu 2 mm tranche noire
F1	50 x 150	3.00 € HT	6.00 € HT	9.00 € HT
F2	100 x 300	5.50 € HT	10.00 € HT	15.00 € HT
F3	150 x 450	12.00 € HT	18.00 € HT	25.20 € HT
F4	200 x 600	19.00 € HT	24.70 € HT	32.11 € HT

Les caractères de couleur **ROUGE** du tableau vous permettent  
de composer votre référence produit. Exemple : P200-F1-Adh

Franco de port à partir de 300 € HT



F200



F201



F202



F203



F204



F205



F206



F207



**LE + PREVENTI !**

*Personnalisez votre panneau :  
vous choisissez votre pictogramme  
et votre texte, nous le réalisons  
au même prix*

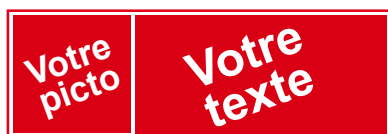

F208



## Pictogrammes - Etiquettes - Panneaux Sécurité - Incendie

Panneaux concernant le matériel ou l'équipement de lutte contre l'incendie  
Conformes aux normes européennes pour la signalisation de sécurité  
et la santé sur les lieux de travail (Directive 92/58 du 24 juin 1992)

Matières	Adh Vinyle adhésif	PVC 1,5 mm tranche blanche	Alu 2 mm tranche noire
<b>F1</b> 50 x 50	1.25 € HT	2.50 € HT	3.75 € HT
<b>F2</b> 100 x 100	2.50 € HT	5.00 € HT	7.50 € HT
<b>F3</b> 200 x 200	7.00 € HT	10.50 € HT	15.75 € HT
<b>F4</b> 300 x 300	12.00 € HT	18.00 € HT	23.40 € HT

Les caractères de couleur **ROUGE** du tableau vous permettent  
de composer votre référence produit. Exemple : P300-F4-Alu

Franco de port à partir de 300 € HT



F300



F301



F302



F303



F304



F305

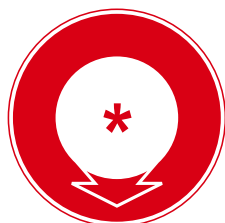

F306



F307



F308



## Pictogrammes - Etiquettes - Panneaux Sécurité - Incendie

Panneaux concernant le matériel ou l'équipement de lutte contre l'incendie  
Conformes aux normes européennes pour la signalisation de sécurité  
et la santé sur les lieux de travail (Directive 92/58 du 24 juin 1992)

Matières	Adh Vinyle adhésif	PVC 1,5 mm tranche blanche	Alu 2 mm tranche noire
<b>F1</b> 50 x 75	2.50 € HT	5.00 € HT	7.50 € HT
<b>F2</b> 100 x 150	4.00 € HT	8.00 € HT	12.00 € HT
<b>F3</b> 150 x 225	10.00 € HT	15.00 € HT	21.00 € HT
<b>F4</b> 200 x 300	15.00 € HT	21.00 € HT	27.30 € HT

Les caractères de couleur **ROUGE** du tableau vous permettent  
de composer votre référence produit. Exemple : P400-F3-PVC

Franco de port à partir de 300 € HT



F400



F401



F402



F403



## Pictogrammes - Etiquettes - Panneaux Information du public

### Panneaux d'information du public

Conformes aux normes européennes pour la signalisation de sécurité et la santé sur les lieux de travail (Directive 92/58 du 24 juin 1992)

Matières	Adh Vinyle adhésif	PVC 1,5 mm tranche blanche	Alu 2 mm tranche noire
<b>F1</b> 50 x 50	1.25 € HT	2.50 € HT	3.75 € HT
<b>F2</b> 100 x 100	2.50 € HT	5.00 € HT	7.50 € HT
<b>F3</b> 200 x 200	7.00 € HT	10.50 € HT	15.75 € HT
<b>F4</b> 300 x 300	12.00 € HT	18.00 € HT	23.40 € HT

Les caractères de couleur **ROUGE** du tableau vous permettent de composer votre référence produit. Exemple : I001-F2-Adh

Franco de port à partir de 300 € HT



I001  
Fragile



I002  
Ne pas mouiller



I003  
Ne pas encombrer



I004  
Toilettes homme



I005  
Toilettes femme



I006  
Toilettes homme



I007  
Toilettes femme



I008  
Toilettes homme



I009  
Toilettes femme



I010  
Toilettes



I011  
Toilettes



I012  
Nursery



I013  
Toilettes PMR



I014  
Toilettes PMR



I015  
Toilettes PMR



I016  
Toilettes PMR homme



I017  
Toilettes PMR femme



I018  
Accès PMR



I019  
Accès incliné PMR



I020  
Accès incliné PMR



I021  
Téléphone PMR



I022  
Téléphone PMR



I023  
Ascenseur PMR

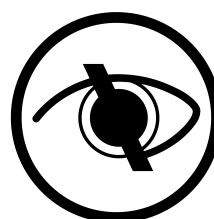

I024  
Accès mal-voyants

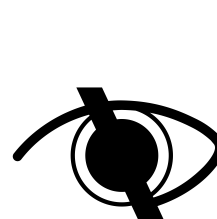

I025  
Accès mal-voyants





## Pictogrammes - Etiquettes - Panneaux Information du public

### Panneaux d'information du public

Conformes aux normes européennes pour la signalisation de sécurité et la santé sur les lieux de travail (Directive 92/58 du 24 juin 1992)

Formats en mm	Matières	Adh Vinyle adhésif	PVC 1,5 mm tranche blanche	Alu 2 mm tranche noire
F1	50 x 50	1.25 € HT	2.50 € HT	3.75 € HT
F2	100 x 100	2.50 € HT	5.00 € HT	7.50 € HT
F3	200 x 200	7.00 € HT	10.50 € HT	15.75 € HT
F4	300 x 300	12.00 € HT	18.00 € HT	23.40 € HT

Franco de port à partir de 300 € HT

Les caractères de couleur **ROUGE** du tableau vous permettent de composer votre référence produit. Exemple : I001-F2-Adh



I026  
Boucle magnétique pour malentendants



I027  
Boucle magnétique pour malentendants



I028  
Equipelement pour malentendants



I029  
Equipelement pour malentendants



I030  
Ascenseur



I031  
Ascenseur



I032  
Ascenseur



I033  
Ascenseur



I034  
Ascenseur



I035  
Ascenseur

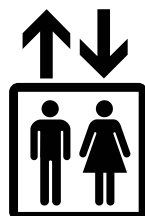

I036  
Ascenseur



I037  
Accès non-voyants



I038  
Accès déplacement ralenti



I039  
Accès non-voyants



I040  
Escaliers



I041  
Attention à la marche



I042  
Accès poussettes



I043  
Téléphone



I044  
Téléphone

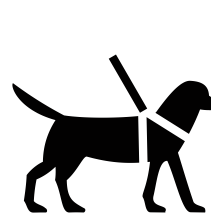

I045  
Chien guide



I046  
Téléphone



I047  
Téléphone



I048  
Téléphone



I049  
Téléphone



I050  
Point information



## Pictogrammes - Etiquettes - Panneaux Information du public

### Panneaux d'information du public

Conformes aux normes européennes pour la signalisation de sécurité et la santé sur les lieux de travail (Directive 92/58 du 24 juin 1992)

Matières	Adh Vinyle adhésif	PVC 1,5 mm tranche blanche	Alu 2 mm tranche noire
<b>F1</b> 50 x 50	1.25 € HT	2.50 € HT	3.75 € HT
<b>F2</b> 100 x 100	2.50 € HT	5.00 € HT	7.50 € HT
<b>F3</b> 200 x 200	7.00 € HT	10.50 € HT	15.75 € HT
<b>F4</b> 300 x 300	12.00 € HT	18.00 € HT	23.40 € HT

Franco de port à partir de 300 € HT

Les caractères de couleur **ROUGE** du tableau vous permettent de composer votre référence produit. Exemple : I051-F3-Adh



I051  
Point information



I052  
Information



I053  
Eau potable



I054  
Eau potable



I055  
Cafétéria



I056  
Cafétéria



I057  
Cafétéria



I058  
Restaurant

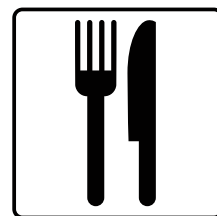

I059  
Restaurant



I060  
Restaurant



I061  
Espace fumeur



I062  
Espace fumeur

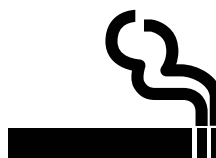

I063  
Espace fumeur



I064  
Espace fumeur

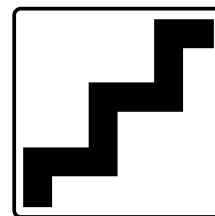

I065  
Escalier

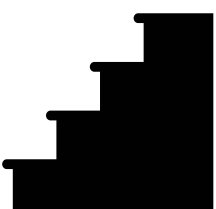

I066  
Escaliers



I067  
Utilisez la corbeille



I068  
Utilisez la corbeille



I069  
Utilisez la corbeille



I070  
Salle d'attente



I071  
Salle d'attente



I072  
Salle d'attente



I073  
Salle d'attente



I074  
Emplacement bagages



I075  
Emplacement bagages





## Pictogrammes - Etiquettes - Panneaux Information du public

### Panneaux d'information du public

Conformes aux normes européennes pour la signalisation de sécurité et la santé sur les lieux de travail (Directive 92/58 du 24 juin 1992)

Formats en mm \ Matières	Adh Vinyle adhésif	PVC 1,5 mm tranche blanche	Alu 2 mm tranche noire
<b>F1</b> 50 x 50	1.25 € HT	2.50 € HT	3.75 € HT
<b>F2</b> 100 x 100	2.50 € HT	5.00 € HT	7.50 € HT
<b>F3</b> 200 x 200	7.00 € HT	10.50 € HT	15.75 € HT
<b>F4</b> 300 x 300	12.00 € HT	18.00 € HT	23.40 € HT

Franco de port à partir de 300 € HT

Les caractères de couleur **ROUGE** du tableau vous permettent de composer votre référence produit. Exemple : I076-F3- PVC

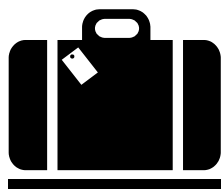

I076  
Bagages



I077  
Bagages



I078  
Objets trouvés



I079  
Objets trouvés

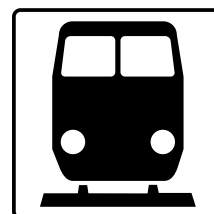

I080  
Train



I081  
Tramway



I082  
Bus



I083  
Camions



I084  
Direction



I085  
Direction



I086  
Bureau



I087  
Peinture fraîche



I088  
Plateforme sans garde-corps

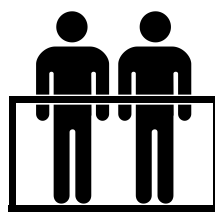

I089  
Plateforme avec garde-corps

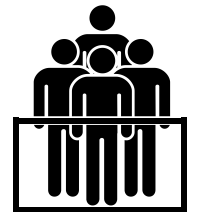

I090  
Plateforme avec garde-corps

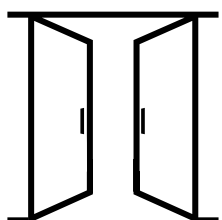

I091  
Ouverture en poussant

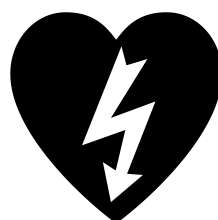

I092  
Stimulateur cardiaque



I093  
Tenez-vous à la rampe



I094  
Salon

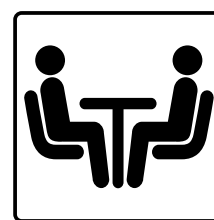

I095  
Salon

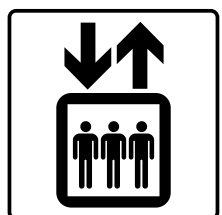

I096  
Ascenseur

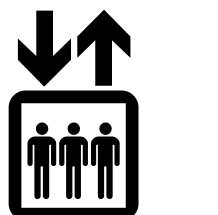

I097  
Ascenseur



I098  
Salle de réunion



I099  
Salle de réunion



I100  
Laverie



## Pictogrammes - Etiquettes - Panneaux Information du public

### Panneaux d'information du public

Conformes aux normes européennes pour la signalisation de sécurité et la santé sur les lieux de travail (Directive 92/58 du 24 juin 1992)

Matières	Adh Vinyle adhésif	PVC 1,5 mm tranche blanche	Alu 2 mm tranche noire
<b>F1</b> 50 x 50	1.25 € HT	2.50 € HT	3.75 € HT
<b>F2</b> 100 x 100	2.50 € HT	5.00 € HT	7.50 € HT
<b>F3</b> 200 x 200	7.00 € HT	10.50 € HT	15.75 € HT
<b>F4</b> 300 x 300	12.00 € HT	18.00 € HT	23.40 € HT

Franco de port à partir de 300 € HT

Les caractères de couleur **ROUGE** du tableau vous permettent de composer votre référence produit. Exemple : I126-F1-Adh

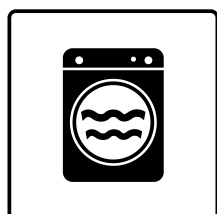

I101  
Laverie



I102  
Laverie

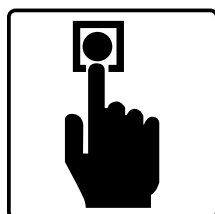

I103  
Sonnette

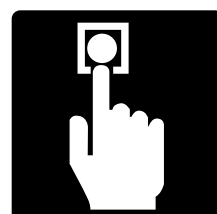

I104  
Sonnette



I105  
Sonnette



I106  
Stop



I107  
Stop



I108  
Stop



I109  
Change bébé



I110  
Change bébé



I111  
Présence d'enfants



I112  
Présence d'enfants



I113  
Avions



I114  
Avions

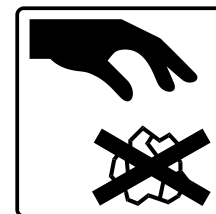

I115  
Ne pas jeter de déchets



I116  
Ne pas jeter de déchets



I117  
Escalator



I118  
Escalator



I119  
Consigne à bagages



I120  
Consigne à bagages



I121  
Consigne à bagages



I122  
?



I123  
?



I124  
?



I125  
Fontaine à eau



## Pictogrammes - Etiquettes - Panneaux Information du public

**Panneaux d'information du public**  
Conformes aux normes européennes pour la signalisation de sécurité  
et la santé sur les lieux de travail (Directive 92/58 du 24 juin 1992)

Formats en mm	Matières	Adh Vinyle adhésif	PVC 1,5 mm tranche blanche	Alu 2 mm tranche noire
<b>F1</b>	50 x 50	1.25 € HT	2.50 € HT	3.75 € HT
<b>F2</b>	100 x 100	2.50 € HT	5.00 € HT	7.50 € HT
<b>F3</b>	200 x 200	7.00 € HT	10.50 € HT	15.75 € HT
<b>F4</b>	300 x 300	12.00 € HT	18.00 € HT	23.40 € HT

Franco de port à partir de 300 € HT

Les caractères de couleur **ROUGE** du tableau vous permettent  
de composer votre référence produit. *Exemple : I126-F1-Adh*



I126  
Fontaine à eau



I127  
Fontaine à eau



I128  
Parking à vélos



I129  
Parking à vélos

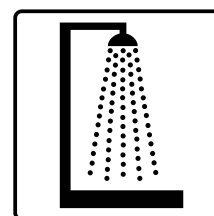

I130  
Douche

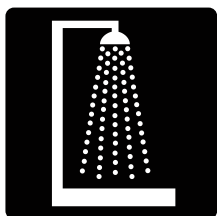

I131  
Douche

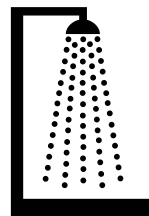

I132  
Douche



I133  
Aire de picnic

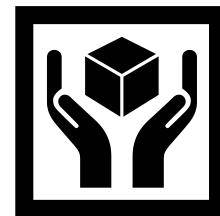

I134  
Manupuler avec précautions

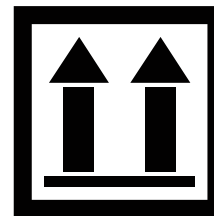

I135  
sens de positionnement

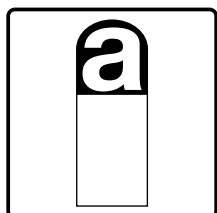

I136  
Amiante



I137  
Amiante



## Pictogrammes - Etiquettes - Panneaux Information du public

### Panneaux d'information du public

Conformes aux normes européennes pour la signalisation de sécurité et la santé sur les lieux de travail (Directive 92/58 du 24 juin 1992)

Matières	Adh Vinyle adhésif	PVC 1,5 mm tranche blanche	Alu 2 mm tranche noire
<b>F1</b> 50 x 50	1.25 € HT	2.50 € HT	3.75 € HT
<b>F2</b> 100 x 100	2.50 € HT	5.00 € HT	7.50 € HT
<b>F3</b> 200 x 200	7.00 € HT	10.50 € HT	15.75 € HT
<b>F4</b> 300 x 300	12.00 € HT	18.00 € HT	23.40 € HT

Franco de port à partir de 300 € HT

Les caractères de couleur **ROUGE** du tableau vous permettent de composer votre référence produit. Exemple : J001-F1-Adh



J001  
Toilettes hommes



J002  
Toilettes femmes



J003  
Toilettes publiques



J004  
Accès PMR



J005  
Toilettes PMR



J006  
Toilettes PMR femmes



J007  
Toilettes PMR hommes



J008  
Cabine téléphonique

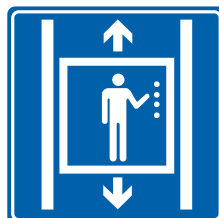

J009  
Ascenseur



J010  
Douches



J011  
Toilettes



J012  
Autorisation de fumer



J013  
Interdiction de fumer



J014  
Information



J015  
Interdit



J016  
Eau potable



J017  
Eau non potable



J018  
Interdit aux animaux



J020  
Escaliers



J021  
Poubelles



J022  
Restaurant



J023  
Café



J024  
Ascenseur handicapés



## Pictogrammes - Etiquettes - Panneaux Transport

### Panneaux transport

Conformes aux normes européennes pour la signalisation de sécurité et la santé sur les lieux de travail (Directive 92/58 du 24 juin 1992)

Formats en mm	Matières	Adh Vinyle adhésif	PVC 1,5 mm tranche blanche	Alu 2 mm tranche noire
F1	50 x 50	1.25 € HT	2.50 € HT	3.75 € HT
F2	100 x 100	2.50 € HT	5.00 € HT	7.50 € HT
F3	200 x 200	7.00 € HT	10.50 € HT	15.75 € HT
F4	300 x 300	12.00 € HT	18.00 € HT	23.40 € HT

Les caractères de couleur **ROUGE** du tableau vous permettent de composer votre référence produit. Exemple : T001-F2-PVC

Franco de port à partir de 300 € HT

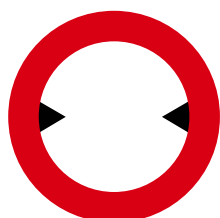

T001  
Largeur limitée



T002  
Interdit de tourner à gauche



T003  
Interdit de tourner à droite



T004  
Parking interdit



T005  
Demi-tour à gauche interdit



T006  
Demi-tour à droite interdit



T007  
Arrêt interdit



T008  
Interdit aux poids lourds



T009  
Interdit aux piétons



T010  
Interdit aux piétons



T011  
Interdit aux bus



T012  
Interdit de klaxonner



T013  
Interdit aux véhicules transportant des marchandises explosives



T014  
Interdit aux véhicules transportant des marchandises susceptibles de polluer les eaux



T015  
Interdit aux piétons



T016  
Interdit aux piétons



T017  
Interdit aux cycles



T018  
Vitesse limitée à 20 km/h



T019  
Vitesse limitée à 30 km/h



T020  
Vitesse limitée à 50 km/h



T021  
Interdit aux véhicules de plus de 5,5 tonnes



T022  
Interdit aux véhicules de plus de 2 tonnes par essieu

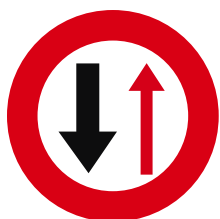

T023  
Priorité au véhicule arrivant en sens inverse

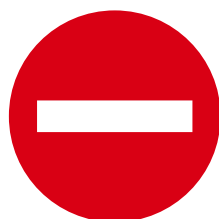

T024  
Sens interdit



T025  
Stop



## Pictogrammes - Etiquettes - Panneaux Transport

### Panneaux transport

Conformes aux normes européennes pour la signalisation de sécurité et la santé sur les lieux de travail (Directive 92/58 du 24 juin 1992)

Formats en mm	Matières	Adh Vinyle adhésif	PVC 1,5 mm tranche blanche	Alu 2 mm tranche noire
F1	50 x 50	1.25 € HT	2.50 € HT	3.75 € HT
F2	100 x 100	2.50 € HT	5.00 € HT	7.50 € HT
F3	200 x 200	7.00 € HT	10.50 € HT	15.75 € HT
F4	300 x 300	12.00 € HT	18.00 € HT	23.40 € HT

Franco de port à partir de 300 € HT

Les caractères de couleur **ROUGE** du tableau vous permettent de composer votre référence produit. Exemple : T026-F1-Adh



T026  
Attention



T027  
Dos d'âne



T028  
Travaux



T029  
Attention enfants



T030  
Attention piétons



T031  
Attention circulation à double sens



T032  
Attention cyclistes



T033  
Rond point



T034  
Intersection

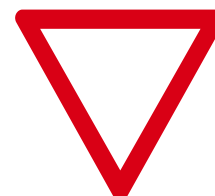

T035  
Cédez le passage



T036  
Sens obligatoire



T037  
Tournez à droite



T038  
Tournez à gauche

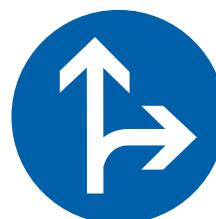

T039  
Sens de circulation

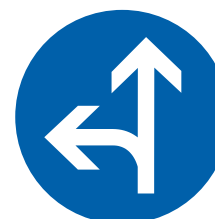

T040  
Sens de circulation





## Pictogrammes - Etiquettes - Panneaux Flèches

### Panneaux concernant la circulation

Conformes aux normes européennes pour la signalisation de sécurité et la santé sur les lieux de travail (Directive 92/58 du 24 juin 1992)

Formats en mm	Matières	Adh Vinyle adhésif	PVC 1,5 mm tranche blanche	Alu 2 mm tranche noire
<b>F1</b>	50 x 50	1.25 € HT	2.50 € HT	3.75 € HT
<b>F2</b>	100 x 100	2.50 € HT	5.00 € HT	7.50 € HT
<b>F3</b>	200 x 200	7.00 € HT	10.50 € HT	15.75 € HT
<b>F4</b>	300 x 300	12.00 € HT	18.00 € HT	23.40 € HT

Franco de port à partir de 300 € HT

Les caractères de couleur **ROUGE** du tableau vous permettent de composer votre référence produit. *Exemple : T033-F4-Alu*

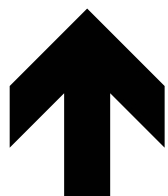

A001



A002

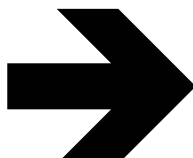

A003



A004



A005

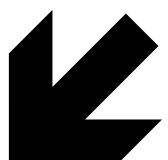

A006

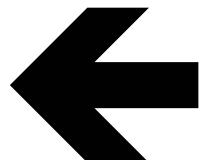

A007

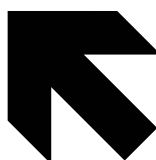

A008

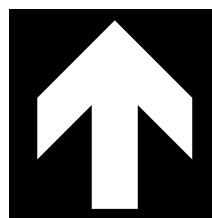

A009

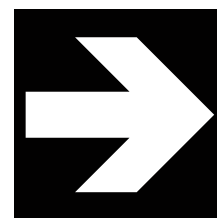

A010

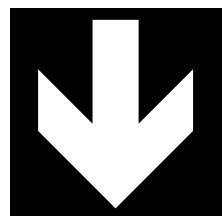

A011

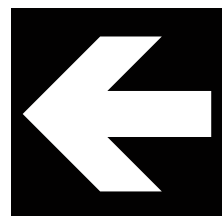

A012

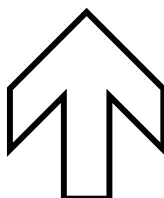

A013

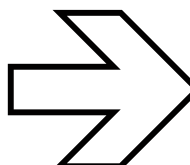

A014

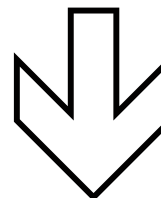

A015

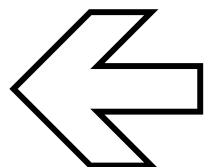

A016



A017



A018

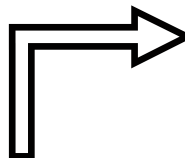

A019

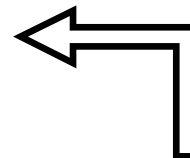

A020

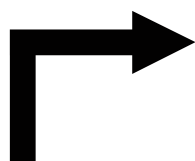

A021

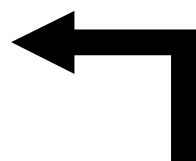

A022



A023

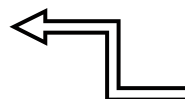

A024



A025



## Pictogrammes - Etiquettes - Panneaux Flèches

Panneaux concernant la circulation

Conformes aux normes européennes pour la signalisation de sécurité et la santé sur les lieux de travail (Directive 92/58 du 24 juin 1992)

Formats en mm	Matières	Adh Vinyle adhésif	PVC 1,5 mm tranche blanche	Alu 2 mm tranche noire
F1	50 x 50	1.25 € HT	2.50 € HT	3.75 € HT
F2	100 x 100	2.50 € HT	5.00 € HT	7.50 € HT
F3	200 x 200	7.00 € HT	10.50 € HT	15.75 € HT
F4	300 x 300	12.00 € HT	18.00 € HT	23.40 € HT

Franco de port à partir de 300 € HT

Les caractères de couleur **ROUGE** du tableau vous permettent de composer votre référence produit. Exemple : T033-F4-Alu



A026

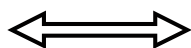

A027



A028

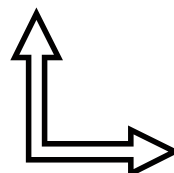

A029

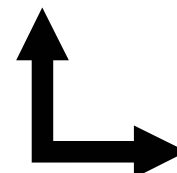

A030

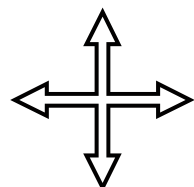

A031

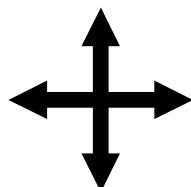

A032

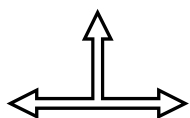

A033

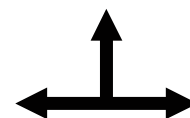

A034

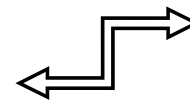

A035

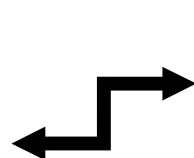

A036

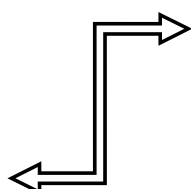

A037

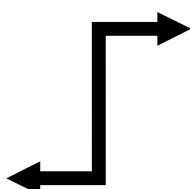

A038

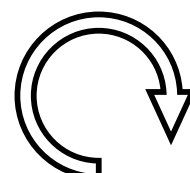

A039

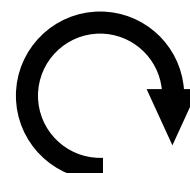

A040

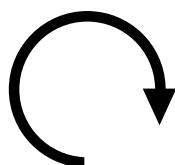

A041



A042



A043

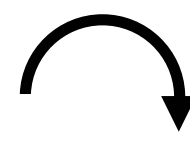

A044



A045



A046



A047



A048



A049



A050



## Pictogrammes - Etiquettes - Panneaux Flèches

Panneaux concernant la circulation

Conformes aux normes européennes pour la signalisation de sécurité et la santé sur les lieux de travail (Directive 92/58 du 24 juin 1992)

Matières	Adh Vinyle adhésif	PVC 1,5 mm tranche blanche	Alu 2 mm tranche noire
<b>F1</b> 50 x 50	1.25 € HT	2.50 € HT	3.75 € HT
<b>F2</b> 100 x 100	2.50 € HT	5.00 € HT	7.50 € HT
<b>F3</b> 200 x 200	7.00 € HT	10.50 € HT	15.75 € HT
<b>F4</b> 300 x 300	12.00 € HT	18.00 € HT	23.40 € HT

Franco de port à partir de 300 € HT

Les caractères de couleur **ROUGE** du tableau vous permettent de composer votre référence produit. Exemple : T033-F4- Alu



A051

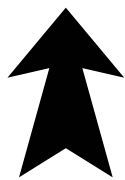

A052



A053



A054

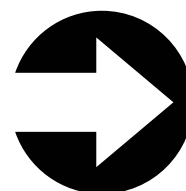

A055

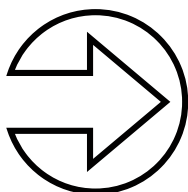

A056

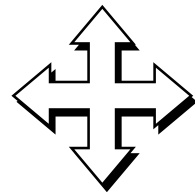

A057

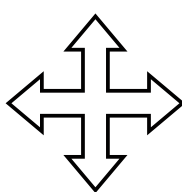

A058



A059



A060



A061



A062



A063

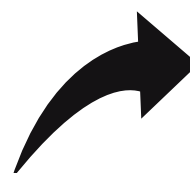

A064

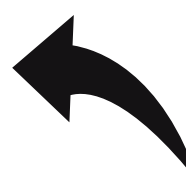

A065

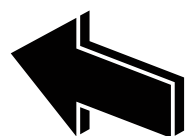

A066



A067

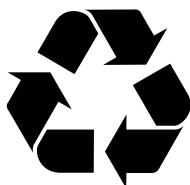

A068

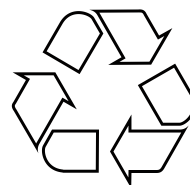

A069

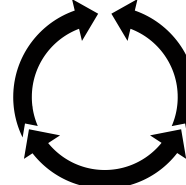

A070

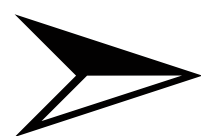

A071

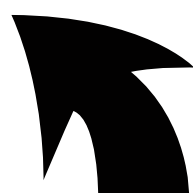

A072

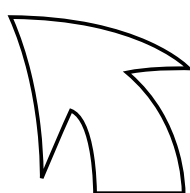

A073

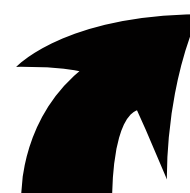

A074



A075



## Pictogrammes danger

### Caractéristiques :

- Forme rectangulaire ;
- Pictogramme rouge cadre noir texte blanc, texte noir ou blanc, fond du panneau jaune, rouge ou blanc.

### Exemple de panneaux à utiliser :



H600



H1000



H1100



### CONSEIL

## Comment choisir sa matière ?

### Adh

### Adhésif

Sur surface lisse. Intérieur ou extérieur.  
Très bonne résistance aux UV, graisses et solvants  
Très bonne adhérence finale offrant une excellente tenue sur une grande variété de supports.

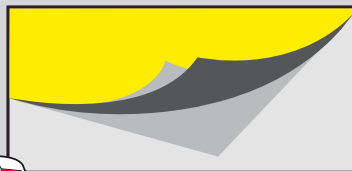

### PVC Plaques PVC 1.5 mm

Sur surface lisse. Intérieur.  
Plaque rigide à structure allégée.  
Classée au feu M1  
Stabilité au vieillissement.

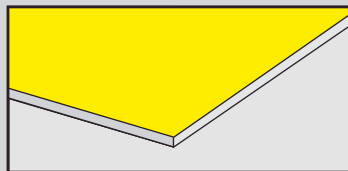

### Alu Plaques ALU 2 mm

Sur toutes surfaces. Extérieur.  
Rigidité équivalente à celle d'une plaque d'aluminium pleine de 2,7 mm  
Très résistante aux chocs et aux intempéries.  
Résistance de -50°C à +90°C  
Classée au feu M1

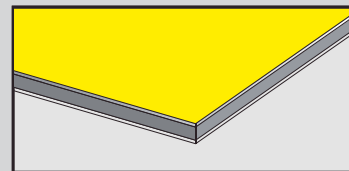

### CONSEIL

## Comment choisir son format de panneau ?

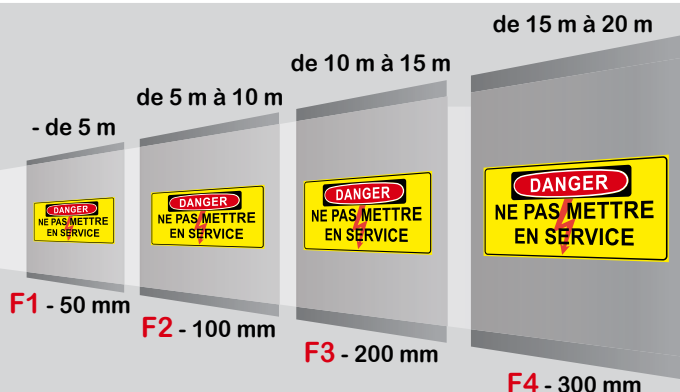

### CONSEIL

## Comment composer sa référence pour commander ?

La référence complète se compose d'une lettre et 3 chiffres pour la référence définissant le motif du panneau suivis de son format (F1, F2, F3 ou F4) et enfin de sa matière (Adh, PVC ou Alu).

Exemple : **H1000-F2-Adh** pour un panneau **Risque de projection d'acide** au **Format 2** (100 mm de largeur) en **Adhésif**.



## Pictogrammes - Etiquettes - Panneaux Danger

### Panneaux danger

Conformes aux normes européennes pour la signalisation de sécurité et la santé sur les lieux de travail (Directive 92/58 du 24 juin 1992)

Matières	Adh Vinyle adhésif	PVC 1,5 mm tranche blanche	Alu 2 mm tranche noire
F1 50 x 100	2.50 €HT	5.00 €HT	7.50 €HT
F2 75 x 150	4.00 €HT	8.00 €HT	12.00 €HT
F3 125 x 250	10.00 €HT	15.00 €HT	21.00 €HT
F4 250 x 500	15.00 €HT	21.00 €HT	27.30 €HT

Les caractères de couleur ROUGE du tableau vous permettent de composer votre référence produit. Exemple : H600-F1-Adh

Franco de port à partir de 300 € HT



H600



H601



H602



H603



H604



H605



H606



H607



H608



H609



H610



H611



H612



H613



H614



H615



H616



## Pictogrammes - Etiquettes - Panneaux Danger

### Panneaux danger

Conformes aux normes européennes pour la signalisation de sécurité et la santé sur les lieux de travail (Directive 92/58 du 24 juin 1992)

Formats en mm	Matières	Adh Vinyle adhésif	PVC 1,5 mm tranche blanche	Alu 2 mm tranche noire
F1	50 x 100	2.50 €HT	5.00 €HT	7.50 €HT
F2	75 x 150	4.00 €HT	8.00 €HT	12.00 €HT
F3	125 x 250	10.00 €HT	15.00 €HT	21.00 €HT
F4	250 x 500	15.00 €HT	21.00 €HT	27.30 €HT

Les caractères de couleur ROUGE du tableau vous permettent de composer votre référence produit. Exemple : H800-F2-Alu

Francis de port à partir de 300 € HT



H800



H801



H802



H803



H804



H805



H806



**LE + PREVENTI !**

*Personnalisez votre panneau : vous choisissez votre texte, nous le réalisons au même prix*



H807





## Pictogrammes - Etiquettes - Panneaux Danger

### Panneaux danger

Conformes aux normes européennes pour la signalisation de sécurité et la santé sur les lieux de travail (Directive 92/58 du 24 juin 1992)

Matières	Adh Vinyle adhésif	PVC 1,5 mm tranche blanche	Alu 2 mm tranche noire
<b>F1</b> 50 x 100	2.50 €HT	5.00 €HT	7.50 €HT
<b>F2</b> 75 x 150	4.00 €HT	8.00 €HT	12.00 €HT
<b>F3</b> 125 x 250	10.00 €HT	15.00 €HT	21.00 €HT
<b>F4</b> 250 x 500	15.00 €HT	21.00 €HT	27.30 €HT

Les caractères de couleur **ROUGE** du tableau vous permettent de composer votre référence produit. Exemple : H1000-F4-PVC

Franco de port à partir de 300 € HT



H1000



H1001



H1002



H1003



H1004



H1005



H1006



H1007



H1008



**LE + PREVENTI !**

*Personnalisez votre panneau : vous choisissez votre texte, nous le réalisons au même prix*



H1009



## Pictogrammes - Etiquettes - Panneaux Danger

### Panneaux danger

Conformes aux normes européennes pour la signalisation de sécurité et la santé sur les lieux de travail (Directive 92/58 du 24 juin 1992)

Formats en mm	Matières	Adh Vinyle adhésif	PVC 1,5 mm tranche blanche	Alu 2 mm tranche noire
F1	50 x 100	2.50 €HT	5.00 €HT	7.50 €HT
F2	75 x 150	4.00 €HT	8.00 €HT	12.00 €HT
F3	125 x 250	10.00 €HT	15.00 €HT	21.00 €HT
F4	250 x 500	15.00 €HT	21.00 €HT	27.30 €HT

Les caractères de couleur ROUGE du tableau vous permettent de composer votre référence produit. Exemple : H1100-F2-Adh

Franco de port à partir de 300 € HT



H1100



H1101



H1102



H1103



H1104



H1105



H1106



**LE + PREVENTI !**

*Personnalisez votre panneau : vous choisissez votre texte, nous le réalisons au même prix*



H1107



Pictogrammes - Etiquettes - Panneaux

## Panneaux officiels Fumeur / Non-fumeur

Décret n°2006 - 1386 du 15 novembre 2006.

Formats	Matières		Adh	PVC
			Vinyle Adhésif	PVC 1.5 mm
<b>F1</b>	<b>A5</b>	<b>150 x 210</b>	6.00 €HT	7.00 €HT
<b>F2</b>	<b>A4</b>	<b>210 x 297</b>	10.00 €HT	×
<b>F3</b>	<b>A3</b>	<b>297 x 420</b>	19.00 €HT	×

Les caractères de couleur **ROUGE** du tableau vous permettent de composer votre référence produit. Exemple : Z001-F2-PVC

Francis de port à partir de 300 € HT

### INTERDICTION DE FUMER



Fumer ici expose à une amende forfaitaire de 68€ ou à des poursuites judiciaires.

Pour **arrêter de fumer**, faites-vous aider en appelant le :  
**39 89** (0.15€/m n depuis un poste fixe. Tabac Info Service)

Décret n° 2006 - 1386 du 15 novembre 2006 fixant les conditions d'application de l'interdiction de fumer dans les lieux affectés à un usage collectif

Z001

### EMPLACEMENT FUMEURS

Interdit aux mineurs de moins de 18 ans.



Fumer augmente les risques de maladies cardiaques et pulmonaires mortelles.

Pour **arrêter de fumer**, faites-vous aider en appelant le :  
**39 89** (0.15€/m n depuis un poste fixe. Tabac Info Service)

Décret n° 2006 - 1386 du 15 novembre 2006 fixant les conditions d'application de l'interdiction de fumer dans les lieux affectés à un usage collectif

Z002

## Espace fumeurs : un nouvel affichage !

Depuis 2007, il est interdit de fumer dans tous les lieux de travail fermés et couverts.

Les entreprises peuvent néanmoins mettre en place, sous certaines conditions, des emplacements à la disposition des fumeurs.

Cette interdiction de fumer et, le cas échéant, la présence d'un espace fumeur, doivent faire l'objet, sous peine d'être condamné à une amende, d'une signalisation apparente dans les locaux de travail, dont les modèles sont fixés par arrêté.

Or ces modèles viennent d'être remis à jour par un arrêté du 1er décembre dernier, afin notamment d'intégrer le nouveau numéro de Tabac Info Service : 39 89

Une mise à jour en principe sans influence pour les employeurs s'agissant de la signalisation de l'interdiction de fumer, puisque ces derniers n'ont pas besoin de modifier leur signalisation si celle-ci a été éditée ou imprimée avant le 11 décembre 2010 conformément aux modèles antérieurs.

Par contre, s'agissant des emplacements fumeurs, l'ancienne signalisation n'est plus valable à compter du 11 mars 2011.

En effet, l'ancien affichage prévoyait l'interdiction de l'emplacement fumeur aux mineurs de moins de 16 ans alors que le nouveau prévoit une interdiction aux mineurs de moins de 18 ans.

Les entreprises dotées d'un espace fumeur sont donc tenues de mettre à jour leur signalisation d'ici cette date.

